

**GENERAL
CATALOGUE
2016/2017**

YMC
EUROPE GMBH

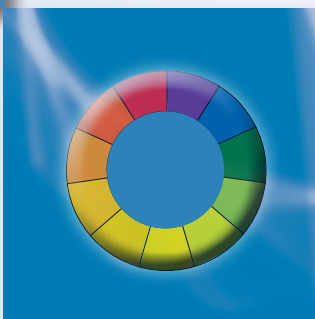

**UHPLC
HPLC
MICRO-LC**

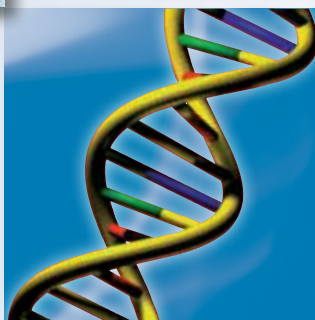

**CHIRAL
SFC
BIO-LC**

Worldwide Availability

If any of your requirements for selecting a chromatography vendor are not addressed in this general catalogue, please contact "your" YMC office below or a local authorised distributor (refer to www.ymc.de). You will find that YMC is always highly responsive to customer requirements, and feedback is guaranteed.

YMC CO., LTD.

YMC Karasuma-Gojo Bld. 284 Daigo-cho,
Karasuma Nisiiru Gojo-dori Shimogyo-ku,
Kyoto 600-8106 Japan
TEL. +81(0)75-342-4515, FAX +81(0)75-342-4550
www.ymc.co.jp

YMC Europe GmbH

Schöttmannshof 19
D-46539 Dinslaken
Germany
TEL. +49(0)2064/427-0, FAX +49(0)2064/427-222
www.ymc.de

YMC America, Inc.

941 Marcon Boulevard Suite 201
Allentown, PA18109 USA
TEL. +1-610-266-8650, FAX +1-610-266-8652
www.ymc-america.com

YMC India Ltd.

CX - 07, 3rd Floor, Lobe - 1,
A-Towers, The Corenthum, Plot No- A-41,
Sector - 62, Noida - 201301 (U.P.) India
TEL. +91(0)120-4276020 - 25, FAX +91(0)120-4276026
www.ymcindia.com

YMC Korea Co., Ltd.

#208, Owners Tower, 16-5, Sunae-dong,
Bundang-gu, Seongnam-si, Gyeonggi-do,
463-825 Korea
TEL. +82-31-716-1631, FAX +82-31-716-1630
www.ymckorea.com

YMC Co., Ltd. Shanghai Rep. Office

Far East International Plaza A2404
No. 319 Xianxia Road, Shanghai 200051
P.R. China
TEL: +86-21-6235-1388, FAX: +86-21-6235-1398
www.ymcchina.com

YMC Taiwan Co., Ltd.

3F, No. 1353, Zhongzheng Rd.,
Taoyuan City, Taoyuan Country 330,
Taiwan (R.O.C.)
TEL. +886-3-2150-630, FAX +886-3-2150-286
www.ymctaiwan.com

YMC Singapore Tradelinks Pte. Ltd.

6 Indus Road, #13-09 Emerald Park, Tower 1,
Singapore 169588
TEL.+65-9023-7617
www.ymc.sg

What's new?

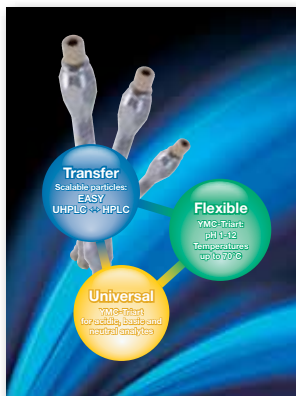

Versatile (U)HPLC columns with 6 modifications to meet every need: YMC-Triart

- robustness
- pH stability (1-12)
- steric recognition
- temperature stability
- UHPLC ↔ HPLC ↔ PREP

page

13



YMC Core-Shell columns: Meteoric Core

- ultra fast separations
- excellent peak shapes with larger pore size
- Meteoric Core BIO
- ideal choice for LC/MS

page

95

These and other recent products/aspects are marked by:



Coated and immobilised polysaccharides: CHIRAL ART

- immobilised / coated
- SFC / SMB
- analytical to preparative LC
- 10 or 20 μm bulk in large quantities
- extremely attractive pricing

page

243



Have a look!



Supercritical Fluid Chromatography columns: Alcyon SFC

- solvent consumption reduced
- fast separation with high resolution
- chiral and achiral stationary phases

page

275

Contents

What's new?	3
-------------	---

Introduction

Company Profile	8-9
YMC Europe's Websites	10-11

YMC-Triart

pH STABLE

Introduction	13
Phases Overview	14
"First Choice" Column for Method Development	15
Particle Technology	16
Specifications	16
pH & Temperature Stability	17
Method Transfer Between HPLC ↔ UHPLC	18-19
UHPLC	20-29
YMC-Triart C18 ExRS	30-31
YMC-Triart Phenyl	32-34
YMC-Triart PFP	35
LC/MS	36-38
Pharmaceuticals	39-43
Food	44-45
Peptides	45
YMC-Triart "AQ" / YMC-Triart C18	46-51
HILIC	52-53
QC Data	54-59
Ordering Information	60-63

YMC-Actus

SEMI-PREP

Introduction	65
Cost Efficiency	66
Axial Compression Technology	67
Secured Hardware Stability	68-69
Effective Method Development on Purification	70-73
Applications	74-75
Preparative Column Selection Finder	76
Linear Scale-Up	77
Ordering Information	78-81

MicroLC

CAPILLARIES

Introduction	83
YMC Capillary Column Hardware	84-85
Gluten in Flour and Cookies	86-87
Allergens in Wine	88-89
Veterinary Drug Residues in Food	90-91
Ordering Information	92-93

Meteoric Core

CORE-SHELL

Introduction	95
Features and Specifications	96
Selectivity Chart	97
Applications	98-100
QC-Data	101
Ordering Information	102

ProFamily

Introduction	105
YMC UltraHT Pro C18 / Hydrosphere C18	106-113
General	114-121
YMC-Pack Pro C18	122-123
YMC-Pack Pro C8	124-125
YMC-Pack Pro C4	126-127
YMC-Pack Pro C18 RS	128-131
Hydrosphere C18	132-133
Ordering Information	134-135

Reversed Phase "Classics"

Introduction	137
Products	138-161
YMC-Pack ODS-AQ, ODS-A, ODS-AM, ODS-AL, PolymerC18, C ₈ (Octyl), Ph (Phenyl), C ₄ (Butyl), TMS (C1), CN (Cyano), YMCbasic	
Ordering Information	162-165

Normal Phase Chemistries

Introduction	167
Products	168-179
YMC-Pack SIL (Silica), PVA-Sil, CN (Cyano), Diol, Polyamine II, NH ₂ (Amino), TMS (C1)	
Ordering Information	180-181

Biochromatography

Introduction	183
Selection Guide	184-185
Ion Exchange (IEX)	187-196
YMC-BioPro QA/SP, YMC-BioPro QA-F/SP-F, YMC-BioPro Q75/S75, Preparative Screening Kits	
Ordering Information	197-198
Size Exclusion (SEC)	199-211
YMC-Pack Diol	
Ordering Information	212
Reversed Phase (RP)	213-221
YMC-Triart C18, YMC-Pack Pro C18, ODS-A, ODS-AQ, Hydrosphere C18	
Ordering Information	222-224
Normal Phase / HILIC (NP/HILIC)	225-228
YMC-Pack Polyamine II	
Ordering Information	228
Glass Columns	
ECO	230-231
Ordering Information	232-234
ECO ^{PLUS}	235-238
Ordering Information	239-240
Pilot Glass and DAU Columns	241

Available Literature (Selection)

Chiral Columns

Introduction	243
CHIRAL ART Coated	244-253
CHIRAL ART Immobilised	254-261
YMC Chiral NEA(R)(S)	262-265
YMC Chiral CD BR	266-269
Contract Purification of Chiral Compounds	270
Ordering Information	271-273

SFC Alcyon

Introduction	275
General	276
Fast Separation with High Resolution	277
Excellent Peak Shape	277
High Column Stability	278
Separation of Phenols	279
Ordering Information	280

Speciality Columns

Introduction	283
YMC Carotenoid	284-285
YMC PAH	286-287
J'sphere ODS	288-293
Ordering Information	294

Flash

Introduction	297
Advantages	298
Application / Product Finder	299
Ordering Information	300

Preparative & Process LC

Introduction	303
General	304-305
YMC-Triart Prep	306-311
YMC*Gel HG-Series	312-317
YMC BioPro - IEX Ion Exchange Media	318-321
Ordering Information	322

Miscellaneous

Technical Information / Introduction	325
Column Handling	326-328
Mobile Phases for RP-Columns	329
HPLC Column Performance	330
Inspection Reports	331
FAQ	332-335
Troubleshooting	336-339
Essential Data	340
Solvent Miscibility Table	341
Column Selection Guide	342-343
Linear Scale Up	344
Preparative Column Selection Guide	345
Substance Index	346-351
Full Listing of all Chemistries and Dimensions ...	352-353
Phase Overview	354-355

Analytical

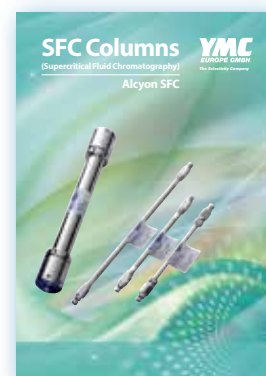
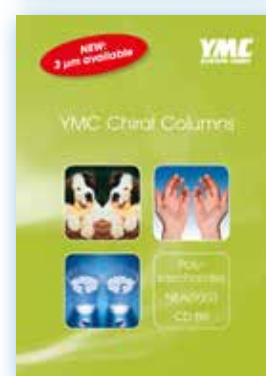
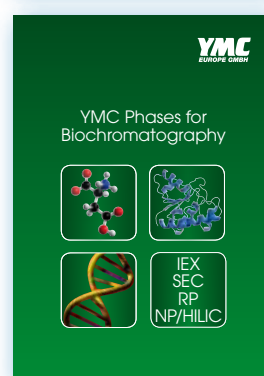

Preparative

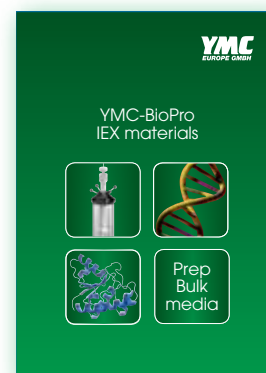

Also available: Posters, Product Information, Technical Guide Lines, Manuals, DMF / RSF / CoA, etc.

[Kinkaku-ji] *japanese*

Kinkaku-ji (Temple of the Golden Pavilion), also known as Rokuon-ji (Deer Garden Temple), is a Zen Buddhist temple in Kyoto, Japan. The garden complex is an excellent example of Muromachi period garden design. The Muromachi period is considered to be a classical age of Japanese garden design. The correlation between buildings and its settings were greatly emphasized during this period. It was a way to integrate the structure within the landscape in an artistic way. The garden designs were characterized by a reduction in scale, a more central purpose, and a distinct setting. A minimalistic approach was brought to the garden design, by recreating larger landscapes in a smaller scale around a structure. It is designated as a National Special Historic Site and a National Special Landscape, and it is one of 17 locations comprising the Historic Monuments of Ancient Kyoto World Heritage Site. It is also one of the most popular buildings in Japan, attracting a large number of visitors annually.



Company Profile

YMC is a leading specialist supplier of high performance products for liquid chromatography, with headquarters in Kyoto, Japan, and with subsidiaries in the USA, India, China, Korea, Taiwan, Singapore and Europe.

As a mission statement, it is our ambition to provide chromatographic solutions for any compound from its discovery through scale-up into production and its ultimate quality control in the laboratory. YMC can always be expected to provide meaningful support, chromatographic tools and assistance for routine R&D, fast LC/UHPLC, high-throughput screening, LC-MS, automation or process-scale engineering.



For all chromatographers
35th
anniversary



YMC Co., Ltd. manufacturing facility in Komatsu, Japan

YMC Europe GmbH, Dinslaken, Germany



As a leading global supplier of high performance products for liquid chromatography, YMC is always striving to be highly innovative. The most recent and interesting premium products from YMC include:

pH and temperature stable (U)HPLC columns and bulk phases: YMC-Triart

Applications using 100% aqueous solvents as well as the separation of similar substances are possible. This allows the whole range of substance polarity to be analysed. Full scalability ensures up- and down-scaling from UHPLC ↔ HPLC ↔ prep scale. Now available in 6 different selectivities for analytical applications.

Bulk media in 10, 15, or 20 µm makes YMC-Triart support available in large quantities for process separations.

Coated and immobilised polysaccharides: CHIRAL ART Polysaccharides

For use in normal phase, reversed phase, polar organic and SFC modes with remarkable stability. Available in prepacked columns with 3 or 5 µm particles as well as in multi-kilogram bulk scale materials with 10 or 20 µm particles at extremely attractive prices.

YMC micro/nanoLC columns

Highly efficient separations using small sample sizes and low flow rates with nano- or micro-LC/MS systems with high sensitivity are now possible with YMC capillary columns. Available packed with every YMC reversed phase, normal phase /HILIC stationary phase in very robust column hardware. The choice of standard 1/16 inch or 1/32 inch fittings allows these columns to be used in all nano- or micro-LC systems.

However, it is not only product specification that demonstrates YMC qualities, but also the perceived ethical values of having people willingly contribute competent and consistent performance along with exceptional reliability even for difficult and demanding separations. YMC strive to exceed expectations

- day after day
- year after year
- lab-to-lab
- site-to-site
- with worldwide availability and with guaranteed long-term supply.

Company Profile



Hands-on support services are offered by Komatsu/Japan, California/USA, Noida/India and Dinslaken/Germany: local application laboratories and the Komatsu factory provide method development, optimisation and scale-up as well as custom synthesis and toll manufacturing (GMP-compliant) from milligram to ton scale.

Facilities include preparative HPLC, fraction concentration equipment, crystallisation, vacuum filtration, vacuum drying, freeze drying, all supported by state-of-the-art analytical instrumentation. YMC workshops are available with a well-defined balance of theory and practical work at either novice or advanced levels, all of which can be customised to individual requirements.



Supply

Extensive local inventory and highly motivated order processing staff ensure speedy product supply to virtually any destination. In addition, authorized YMC International Distributors are encouraged to maintain local inventory, too, occasionally complemented by consignment products provided by YMC, so that lead times are brought down to a minimum.

The ideal laboratory resource: www.ymc.de

- more than 750 pages full of useful information
- extensive applications database
- increased number of documents available for downloading
- support services including regulatory compliance information

YMC Europe's website is the ideal laboratory resource for chromatography application support and product knowledge for the pharmaceutical, chemical, biochemical, environmental, food and beverage industries.

“Chromatography”:

The full spectrum of YMC's products for micro/nano LC, (U)HPLC, analytical LC and preparative separations:

- RP, IEX, SEC, HILIC, NP and SFC columns
- UHPLC and HPLC products
- Capillary columns to fit the majority of nano/microLC systems
- YMC-Triart Prep bulk: the bulk media with enhanced pH stability available in industrial scale quantities
- CHIRAL ART: coated/immobilised cost-efficient YMC chiral bulk media and HPLC columns*
- Column technologies: laboratory and pilot scale glass columns, DAC prep/pilot steel columns

The screenshot shows the YMC website interface. At the top, there is a navigation bar with the YMC logo and links for 'Chromatography', 'Applications', 'Expertise & Service', 'Synthesis', and 'Company'. The main content area features a large blue banner with the headline '(U)HPLC for Hydrophobic Substances and Isomers' and a sub-headline 'Unique YMC Triart C18 ExRS columns with extended pH and selectivity.' Below the banner, there are several content tiles: 'Chromatography' (with a pipette icon), 'Applications' (with a blue liquid icon), 'News' (with a date 'January 2015' and a small article preview), 'Expertise and Service' (with a person in a lab coat icon), 'YMC Premium' (with a play button icon), 'Synthesis' (with a laboratory flask icon), and 'Contact' (with a speech bubble and person icon). A 'See Below Tragedy?' button is located at the bottom right of the page.

* Prep 10 µm or 20 µm freely available

The ideal laboratory resource: www.ymc.de

“Applications”:

Free access to YMC’s own application database: with its over 2,500 different compounds in more than 750 state-of-the-art applications!

“Expertise and Service”:

Overview on all the support YMC can provide, e.g.:

- Method development and (chiral) phase screening services to support you with the selection of the most appropriate YMC column and/or method conditions.
- Custom purifications from laboratory to pilot or process scale performed in Dinslaken, Germany or Komatsu, Japan.
- Troubleshooting support for most common questions.

“YMC Premium”:

Download section exclusively for registered members. Here you can find all downloadable documents, which are only accessible after login, e.g. in-depth product information, price lists, regulatory support documentation etc.

“Contact”:

All possible contact details including direct contact numbers, call-back service, phone numbers and email addresses.

In addition, you can find the direct contact details for your product specialist on each of the corresponding product pages.

We are online - chat with us —

ONLINE Start Chat

Welcome to our Online Support! To help us serve you better, please provide some information before initiating the chat with a representative.

Name:

Email:

Company:

Question:

Department:

Options LiveZilla Live Help

Direct Answers to Your Questions?

Please contact YMC via our (free) online chat for immediate answers to technical or commercial issues or to arrange for personal discussions at your site; YMC specialists are available to respond to your questions and issues on www.ymc.de!



To find out more please visit our new website at www.ymc.de and see what extra YMC Europe can offer you at no extra cost!



Transfer

Scalable particles:
EASY
UHPLC ↔ HPLC

Flexible

pH = 1 – 12
Temp. up to 70°C
100% aqueous
conditions

Universal

YMC-Triart
for acidic, basic and
neutral analytes

YMC-Triart

Contents

Phases Overview	14
“First Choice” Column for Method Development	15
Particle Technology.....	16
Specifications	16
pH & Temperature Stability.....	17
Method Transfer Between HPLC↔UHPLC	18-19
UHPLC	20-29
 YMC-Triart C18 ExRS	30-31
YMC-Triart Phenyl	32-34
YMC-Triart PFP	35
LC/MS.....	36-38
Pharmaceuticals	39-43
Food	44-45
Peptides	45
YMC-Triart „AQ“ / YMC-Triart C18.....	46-51
HILIC	52-53
QC Data	54-59
Ordering Information.....	60-62

Introduction

Chromatographers always seek to push the limits of HPLC columns to greater extremes to allow them to perform day-to-day with ever-changing pH, buffers and temperature ranges. The column for the laboratory of today must be suitable for harsh pH conditions in combination with high temperature ranges without sacrificing selectivity. In addition narrow, symmetrical peak shapes are necessary in order to cope with rapid analysis of demanding samples. This has required manufacturers to seek more innovative ways to produce suitable stationary phases.

In order to meet these goals, YMC has developed a new particle technology. This is based on a particle produced via a tightly controlled granulation technology which has been adapted from micro-reactor technology. The revolutionary production technique provides a silica-organic hybrid stationary phase, which provides an outstandingly narrow pore size and particle size distribution. This in turn, results in low back pressures and high loadability.

Phases Overview

YMC-Triart C18



YMC-Triart C18 ExRS

YMC-Triart C8

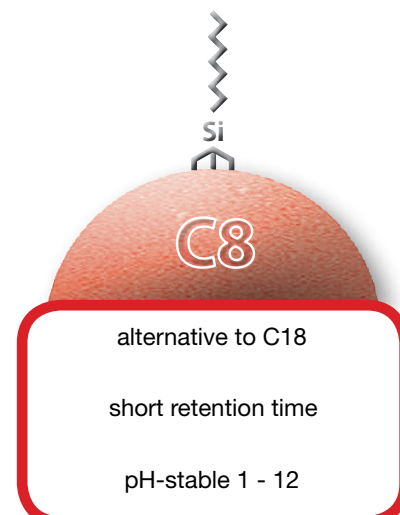
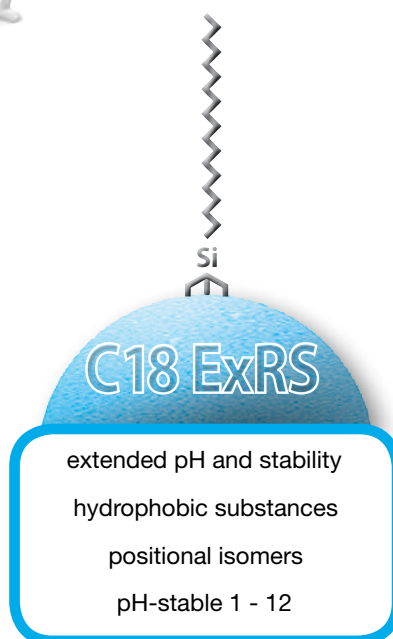
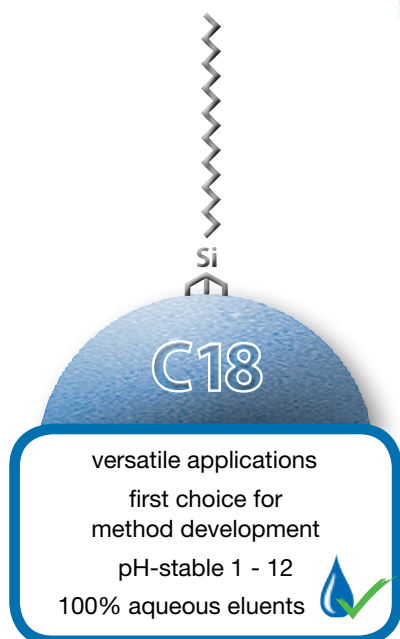

YMC-Triart Phenyl

YMC-Triart PFP

YMC-Triart Diol-HILIC

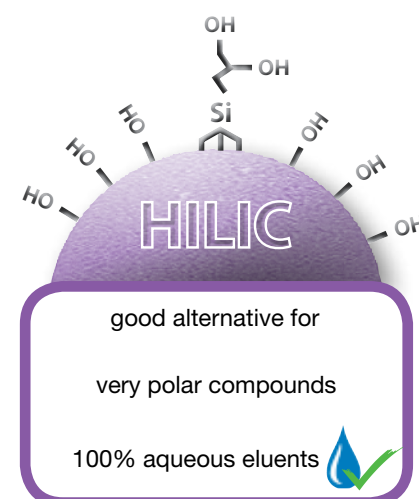
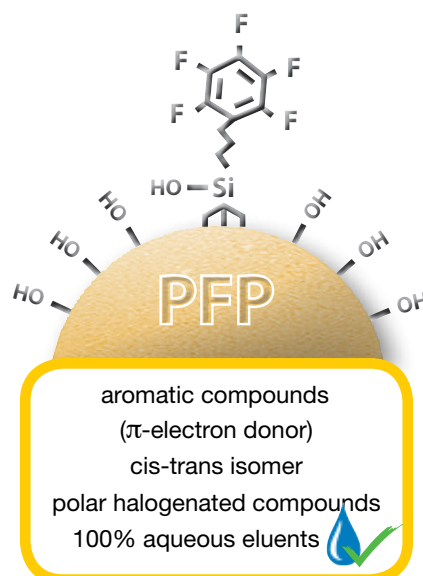
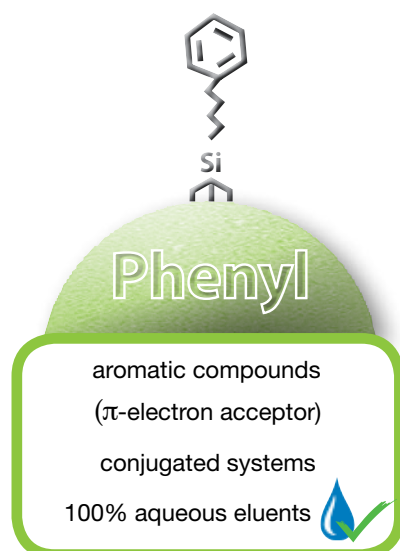

YMC-Triart

“First choice” column for method development

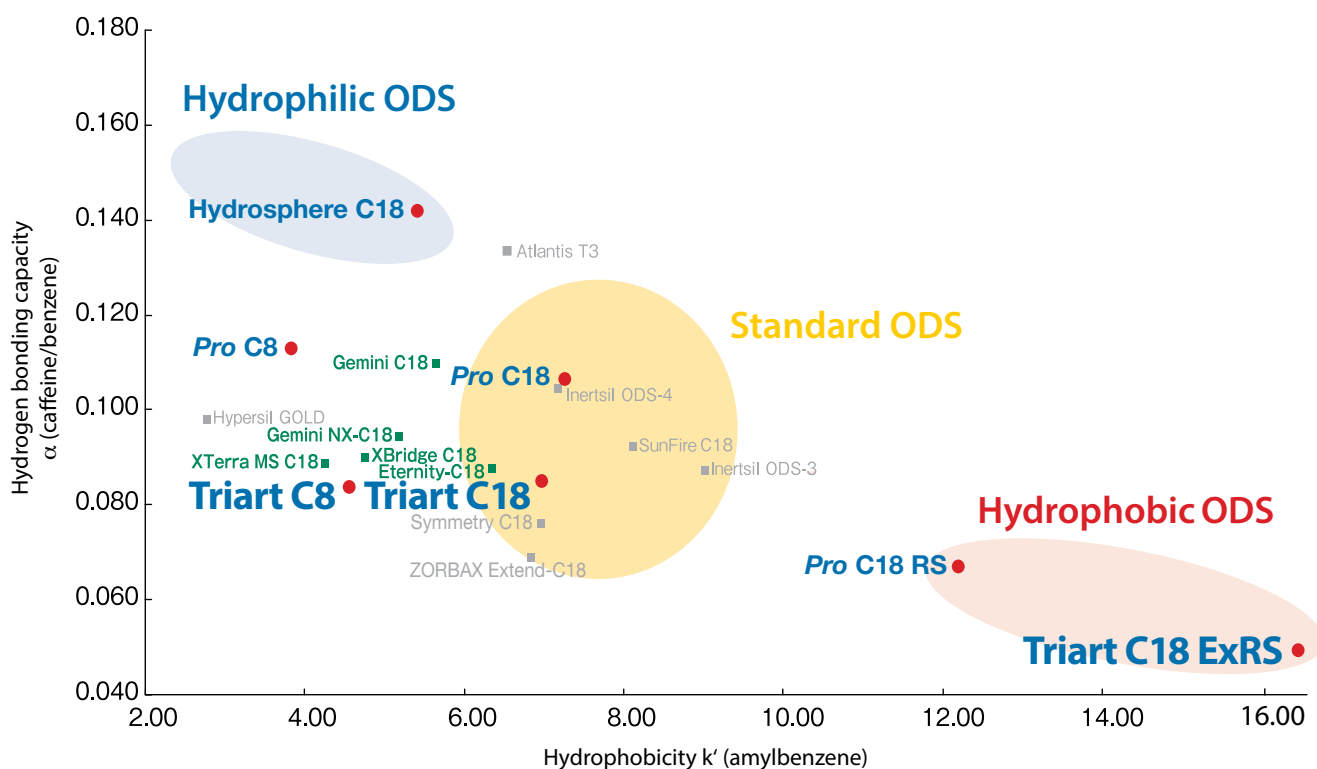

Conventional hybrid silica-based ODS columns tend to be less hydrophobic than silica-based columns. YMC-Triart C18 has a higher carbon load, giving it a hydrophobicity comparable to that of standard ODS columns, thereby making it a “versatile first-choice” column for method development.

On the other hand, YMC-Triart C18 ExRS has been designed to provide contrastingly different separation characteristics!

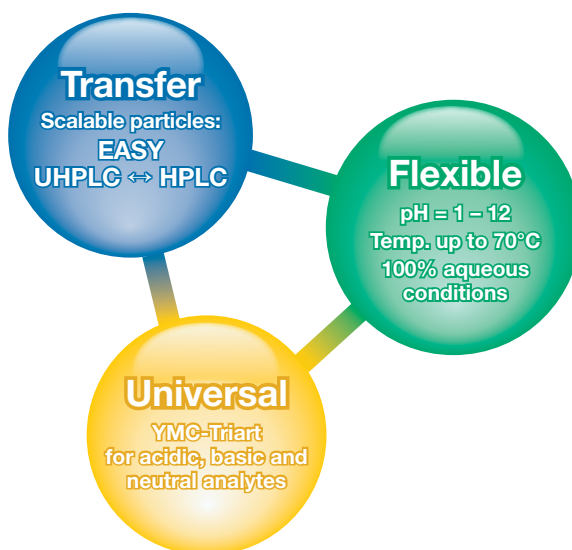







YMC-Triart

Particle technology

YMC-Triart is a versatile material prepared by using tightly controlled particle formation technology which has been adapted from micro-reactor technology. This recently developed production process results in exceptionally narrow particle and pore size distributions.

With YMC-Triart, challenging pH and high temperature conditions are no longer a limitation to the day-to-day work in laboratories. Most importantly, due to its unique particle composition, a balanced hydrophobicity and silanol activity are achieved which makes YMC-Triart a "First Choice" column in method development.

	YMC-Triart C18	YMC-Triart C18 ExRS	YMC-Triart C8	YMC-Triart Phenyl	YMC-Triart PFP	YMC-Triart Diol-HILIC
Base	organic/inorganic silica					
Stationary phase	C18	C18	C8	Phenyl	Pentafluorophenyl	Diol
USP class	L1	L1	L7	L11	L43	L20
Particle size	1.9, 3 and 5 µm					
Pore size	12 nm	8 nm	12 nm	12 nm	12 nm	12 nm
Specific surface	360 m ² /g	430 m ² /g	360 m ² /g	360 m ² /g	360 m ² /g	360 m ² /g
Carbon content	20%	25%	17%	17%	15%	—
Bonding	trifunctional					
Endcapping	multi-stage	multi-stage	multi-stage	multi-stage	none	none
pH range	1 ~ 12	1 ~ 12	1 ~ 12	1 ~ 10	1 ~ 8	2 ~ 10
Temp. range	pH 1-7: 70 °C, pH 7-12: 50 °C	pH 1-7: 70 °C, pH 7-12: 50 °C	pH 1-7: 70 °C, pH 7-12: 50 °C	50°C	50°C	50°C
100% aqueous eluents						

pH & Temperature

Versatile wide pH stability

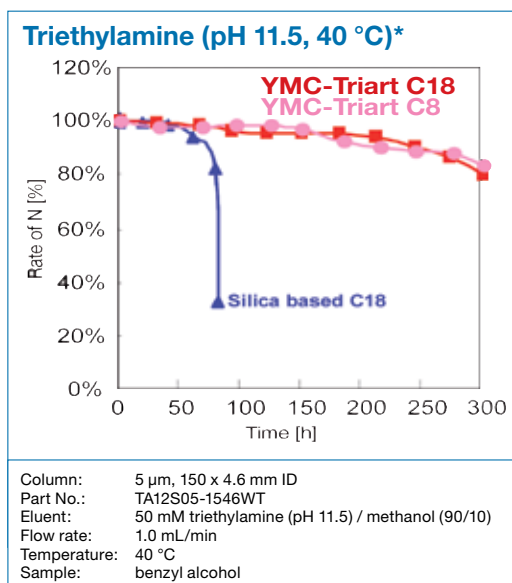
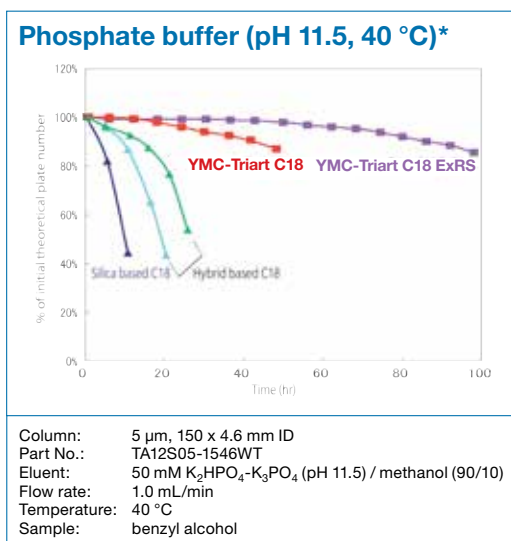

Stability at high temperature

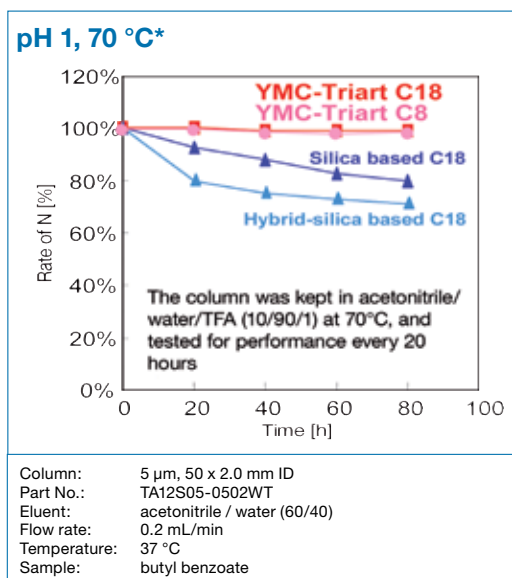
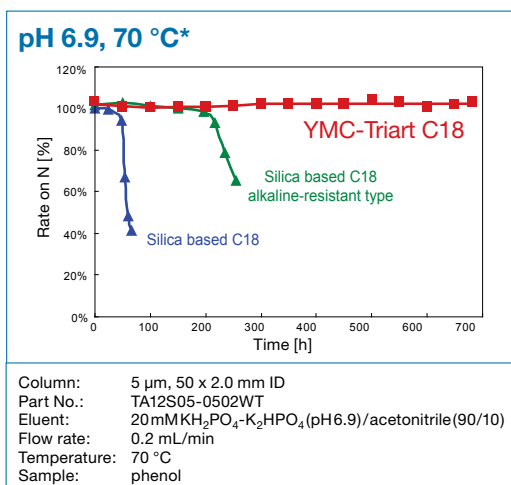

YMC-Triart phases show great chemical stability due to the newly developed hybrid-silica. Even under high pH or high temperature conditions, the lifetime of YMC-Triart phases is more than 10x greater than conventional reversed phase columns.

Transfer HPLC ↔ UHPLC

Secure your method transfer!

Differences in selectivity, retention time, and also peak shapes between different particle sizes of commercially available C18 phases in the same brand (or an alternative as recommended by its manufacture) have been observed.

YMC-Triart C18

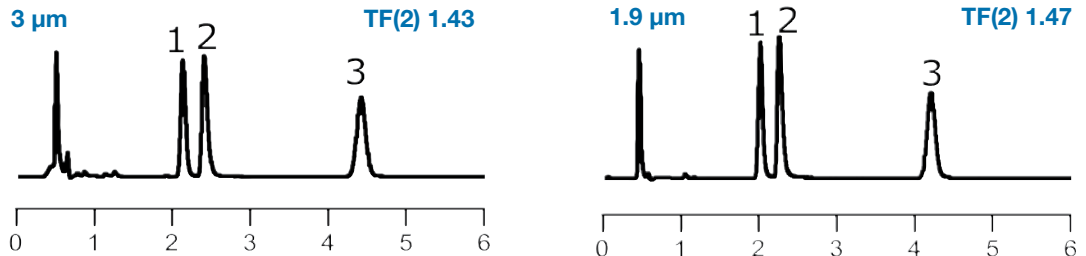

YMC has addressed this issue of method transfer. YMC-Triart columns show identical selectivity and excellent peak shapes for basic compounds for all 3.0 µm to 1.9 µm particle sizes. It allows predictable scale up from UHPLC to conventional HPLC and even to semi-preparative LC, and vice versa.

Case Studies**

X-Bridge BEH C18 and Acquity UPLC BEH C18

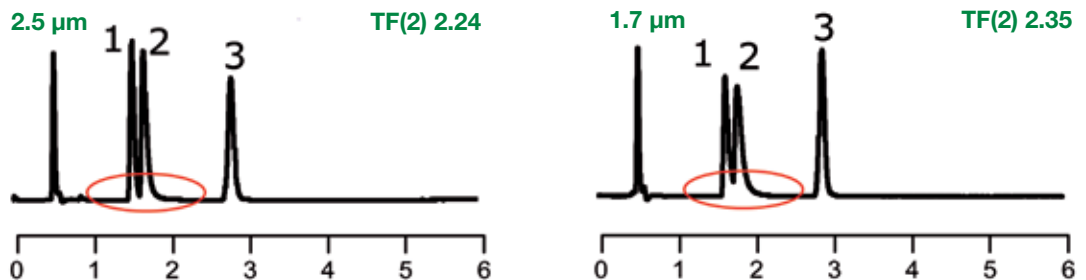

Kinetex™ C18

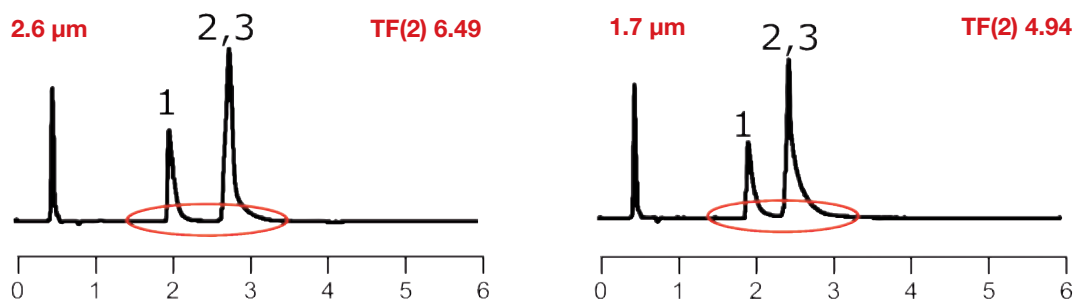

Kinetex™ C18 columns show significant peak tailing and have limited scalability due to lack of larger particle sizes.

Column: 50 x 2.0 mm ID or 2.1 mm ID
 Eluent: 20 mM KH_2PO_4 - K_2HPO_4 (pH 6.9) / acetonitrile (65/35)
 Temperature: 40 °C
 Flow rate: 0.2 mL/min
 Detection: UV at 235 nm

1. Chlorpheniramine (basic)
 2. Dextromethorphan (basic)
 3. Propyl paraben (internal standard)

** These observations might not be representative for all applications.

Transfer HPLC ↔ UHPLC

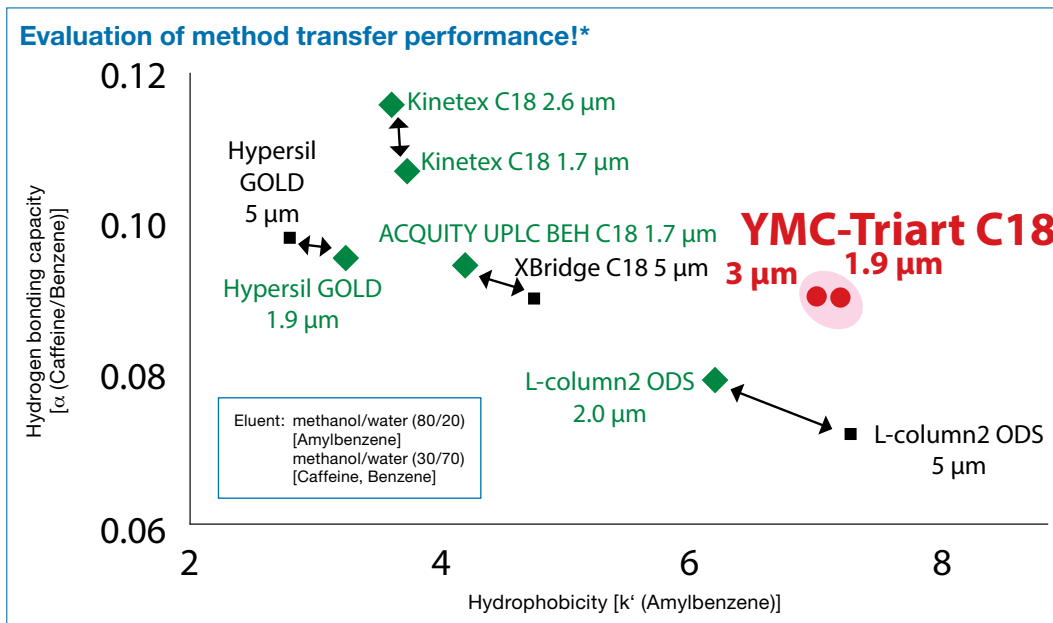

With the introduction of UHPLC, sub-2- μm particles became necessary. Therefore smaller particles have been added to existing column lines. Consequently, sub-2- μm particles may exhibit differences in chromatographic performance.

By introducing YMC-Triart, YMC provides matching chromatographic behaviour for all particles sizes!

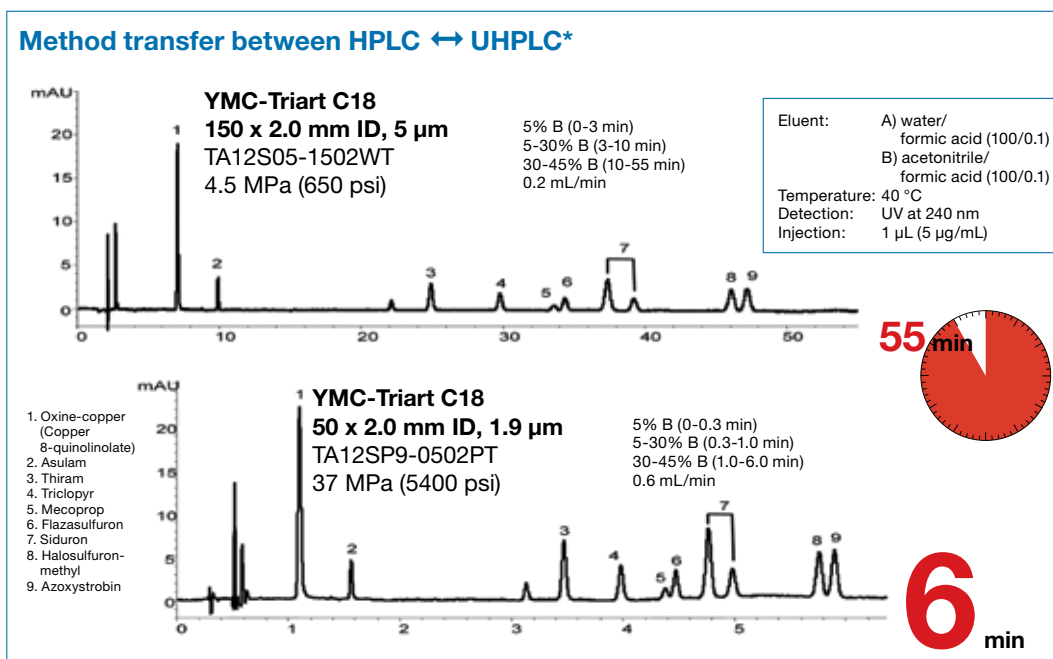

When transferring the 55 min HPLC method to UHPLC scale, the resolution remains the same although the separation time is reduced to only 6 min.

UHPLC

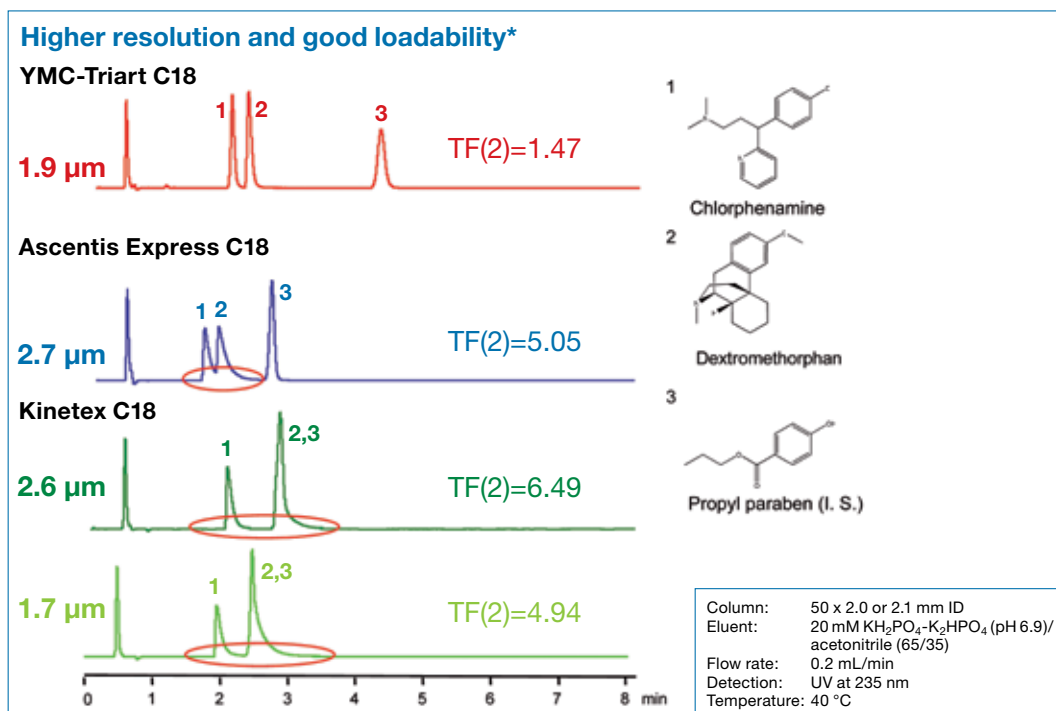

YMC-Triart C18 shows superior resolution to the other three phases thereby allowing considerable higher loadability.

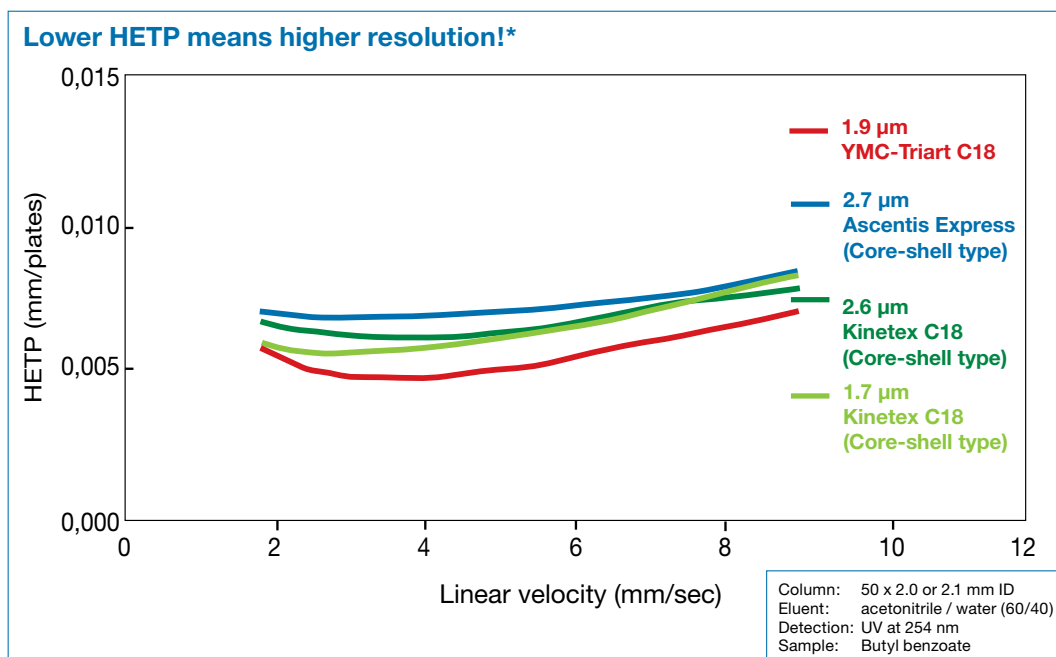

YMC-Triart C18 always shows the lowest HETP compared to the three Core-Shell products over the range of linear velocity applied.

UHPLC & MS

Determination of Artificial Sweeteners with LC-MS/MS

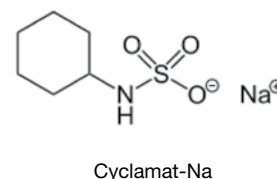
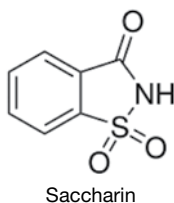
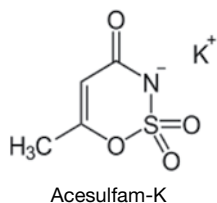

→ Non-biological markers of wastewater entries in ground and surface water

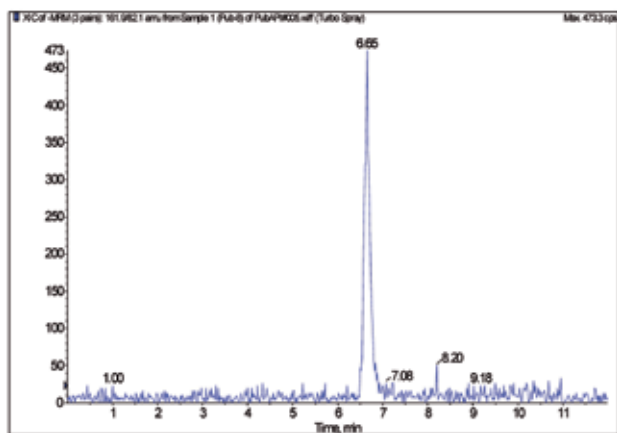

Extracted Ion Chromatogram (XIC) of Acesulfam-K, 0.1 µg/L

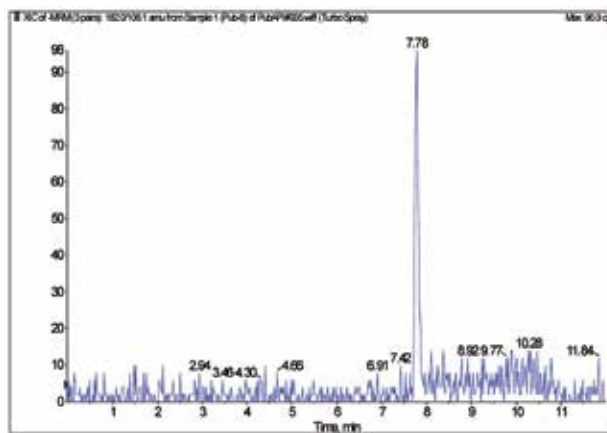

Extracted Ion Chromatogram (XIC) of Saccharin, 0.1 µg/L

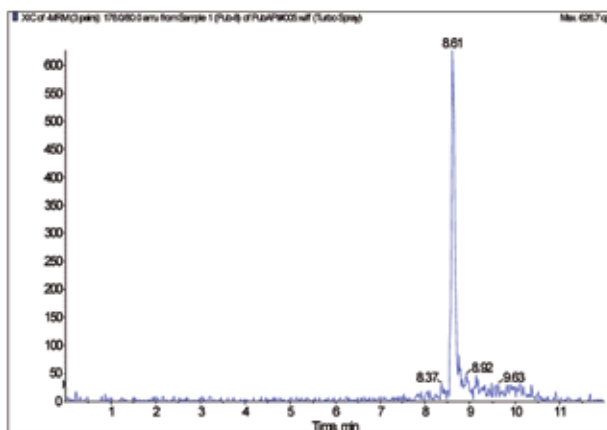

Extracted Ion Chromatogram (XIC) of Cyclamat-Na, 0.1 µg/L

Column: YMC-Triart C18, 12 nm, 1.9 µm, 100 x 3.0 mm ID
 Part No.: TA12SP9-1003PT
 LC-System: Agilent 1100 HPLC system and CTC Analytics HTC-Pal Autosampler
 MS/MS System: Applied Biosystems MDS Sciex API 4000, ESI negative
 Temperature: 35°C
 Flow rate: 0.3 mL/min
 Injection: 40 µL, direct injection
 Eluent: A: H₂O (containing 10 mmol NH₄ formate)
 B: MeOH (containing 10 mmol NH₄ formate)
 Gradient: Time 0 6.0 6.1 12.0
 % B 2 75 2 2

by courtesy of: Thomas Class, Sandro Jooß
 PTRL Europe, Helmholtzstraße 22, Science Park I, D-89081 Ulm

UHPLC

Angiotensin I, II and III*

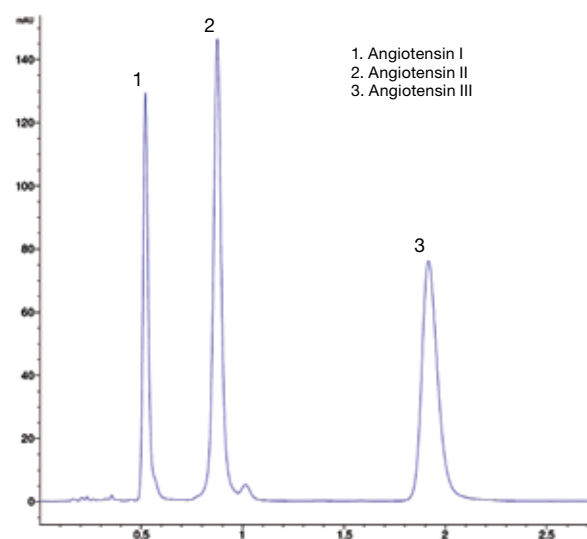

Column: YMC-Triart C18, 12 nm, 1.9 μ m, 50 x 2.0 mm ID
Part No.: TA12SP9-0502PT
Eluent: 20 mM KH_2PO_4 + K_2HPO_4 (pH 7.9) / acetonitrile (22/78)
Flow rate: 0.7 mL/min
Detection: UV at 220 nm
Pressure: 720 bar
Injection: 0.5 μ L
Temperature: 40 $^\circ\text{C}$

Insulin*

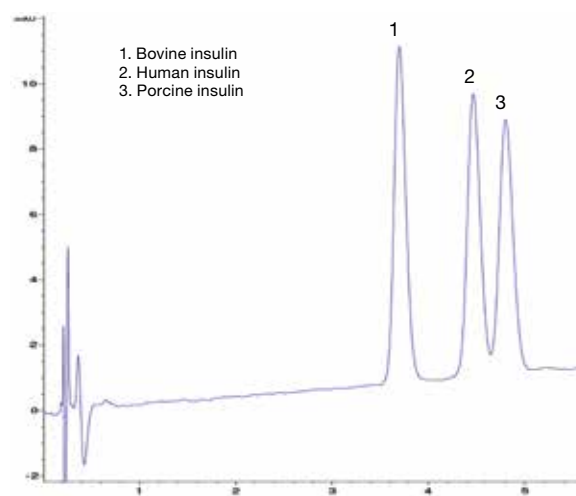

Column: YMC-Triart C18, 12 nm, 1.9 μ m, 50 x 2.0 mm ID
Part No.: TA12SP9-0502PT
Eluent: A) H_2O + 0.1% TFA
B) acetonitrile + 0.1% TFA
Gradient: 30% B (0 min); 30-32% B (0-5 min); 32% B (55 min)
Flow rate: 0.6 mL/min
Detection: UV at 220 nm
Pressure: 611 bar
Injection: 0.5 μ L
Temperature: 30 $^\circ\text{C}$

Macrolide antibiotics*

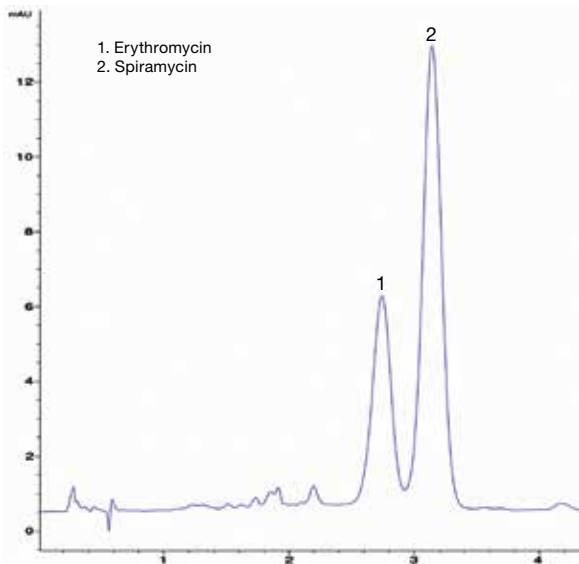

Column: YMC-Triart C18, 12 nm, 1.9 μ m, 50 x 2.0 mm ID
Part No.: TA12SP9-0502PT
Eluent: A) 20 mM K_2HPO_4 + 20 mM KH_2PO_4 (pH 7.9)
B) acetonitrile
Gradient: 60% B (0.5 min); 60-70% B (0.5-1.5 min); 70% B (3.5 min)
Flow rate: 0.45 mL/min
Detection: UV at 210 nm
Pressure: 520 bar
Injection: 1 μ L
Temperature: 50 $^\circ\text{C}$

Sulpha drugs*

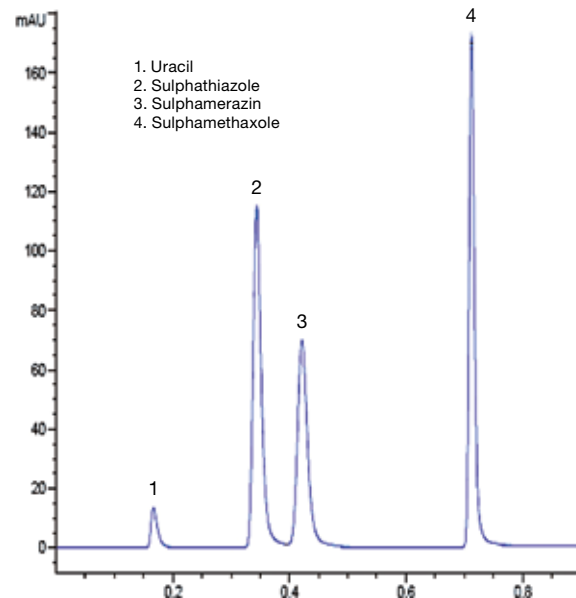

Column: YMC-Triart C18, 12 nm, 1.9 μ m, 50 x 2.0 mm ID
Part No.: TA12SP9-0502PT
Eluent: H_2O + formic acid (pH 2.5) / acetonitrile (75/25)
Flow rate: 0.75 mL/min
Detection: UV at 280 nm
Pressure: 740 bar
Injection: 0.5 μ L
Temperature: 50 $^\circ\text{C}$

UHPLC

Tetracycline antibiotics*

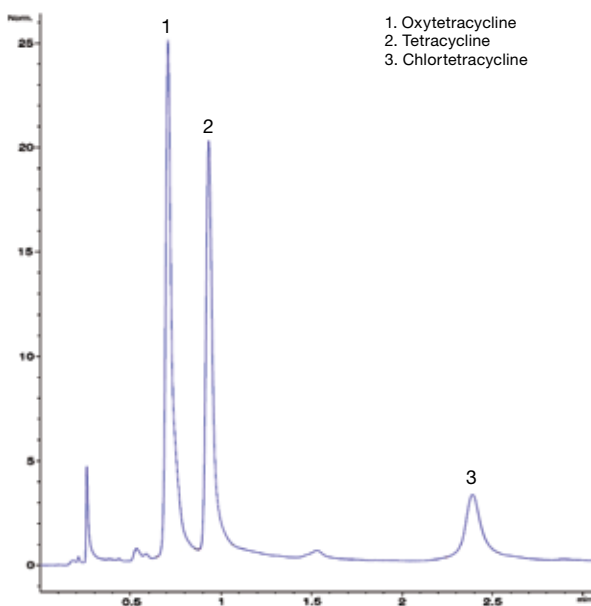

- 1. Oxytetracycline
- 2. Tetracycline
- 3. Chlortetracycline

Column: YMC-Triart C18, 12 nm, 1.9 μ m, 50 x 2.0 mm ID
 Part No.: TA12SP9-0502PT
 Eluent: 5 mM CH₃COONH₄ / acetonitrile (87/13)
 Flow rate: 0.65 mL/min
 Detection: UV at 280 nm
 Pressure: 662 bar
 Injection: 1 μ L
 Temperature: 40 °C

Betablockers*

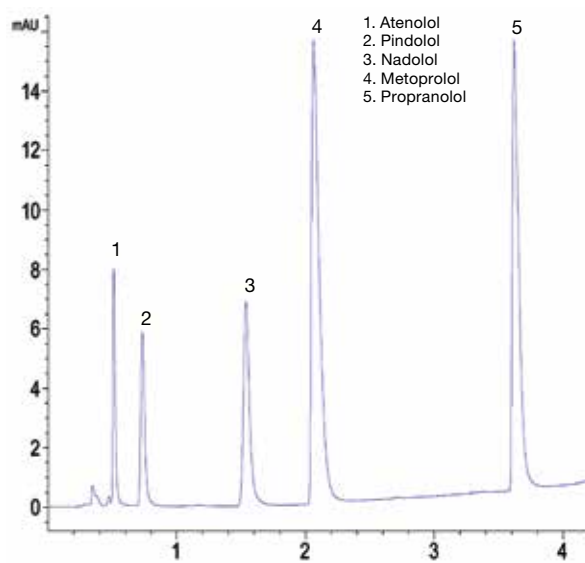

- 1. Atenolol
- 2. Pindolol
- 3. Nadolol
- 4. Metoprolol
- 5. Propranolol

Column: YMC-Triart C18, 12 nm, 1.9 μ m, 50 x 2.0 mm ID
 Part No.: TA12SP9-0502PT
 Eluent: A) 20 mM CH₃COONH₄ + ammonia (pH 9.0)
 B) acetonitrile
 Gradient: 25% B (1.0 min); 75% B (1-6 min)
 Flow rate: 0.35 mL/min
 Detection: UV at 254 nm
 Pressure: 450 bar
 Injection: 1 μ L
 Temperature: 40 °C

Fast LC for conventional HPLC*

YMC-Triart C18, 5 μ m, 150 x 2.0 mm ID

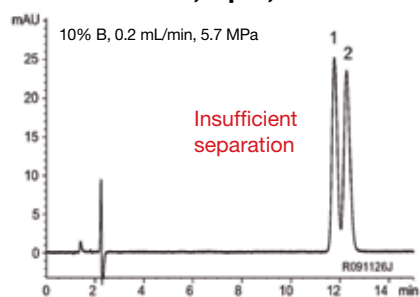

optimisation

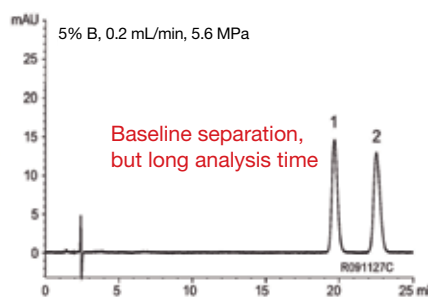

Down scaling

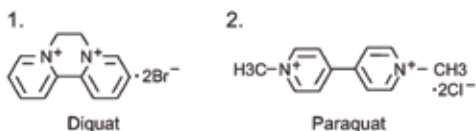

YMC-Triart C18, 3 μ m, 50 x 2.0 mm ID

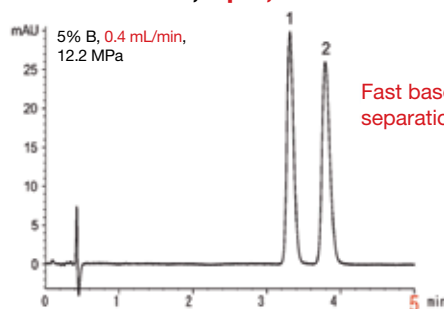

Eluent: A) water / HFBA* (100/0.1)
 B) acetonitrile / HFBA* (100/0.1)
 Temperature: 37 °C
 Detection: UV at 290 nm
 Injection: 1 μ L (0.1 mg/mL)
 *heptafluorobutyric acid

UHPLC

Antidepressants*

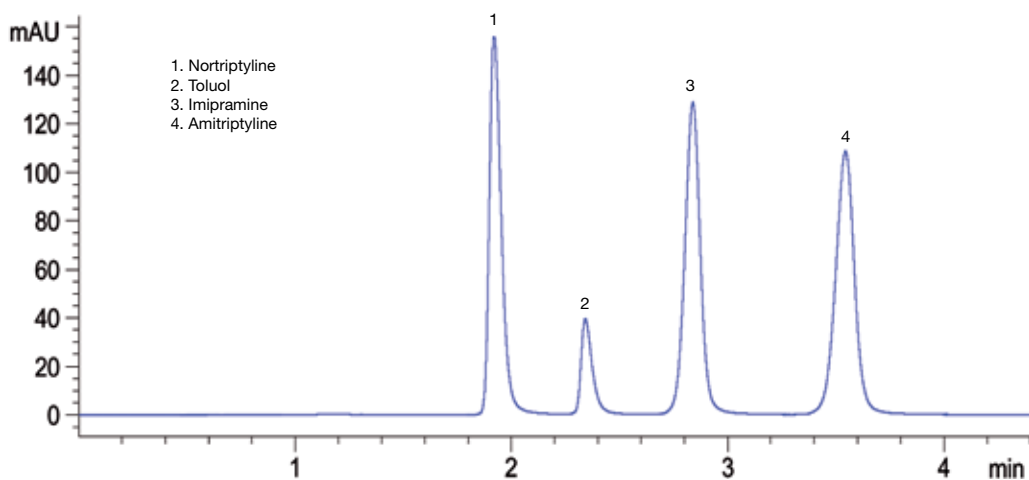

Column: YMC-Triart Phenyl, 1.9 μ m (100 x 2.0 mm ID)
Part No.: TPH12SP9-1002PT
Eluent: methanol / 25 mM KH_2PO_4 (pH 6.0) (65/35)
Flow rate: 0.4 mL/min
Detection: UV at 254 nm
Injection: 2 μ L
Temperature: 25 $^\circ\text{C}$

Resorcinol*

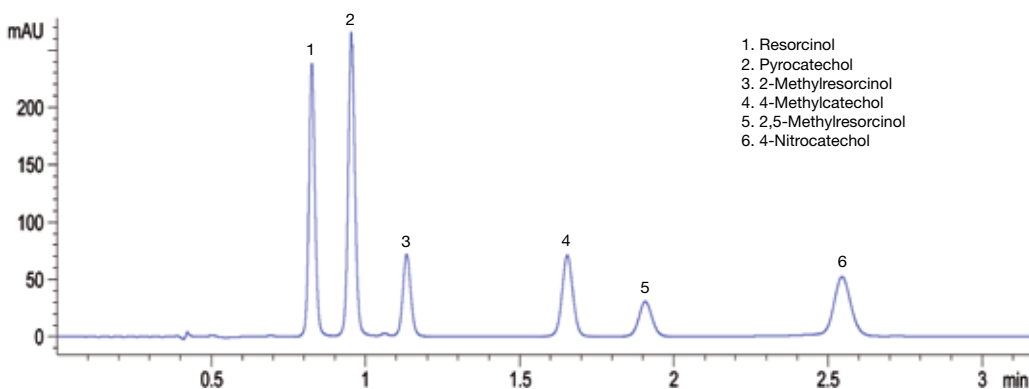

Column: YMC-Triart PFP, 1.9 μ m (100 x 2.0 mm ID)
Part No.: TPF12SP9-1002PT
Eluent: water + 0.1% formic acid / acetonitrile + 0.1% formic acid (85/15)
Flow rate: 0.8 mL/min
Detection: UV at 270 nm
Injection: 0.5 μ L
Temperature: 25 $^\circ\text{C}$

UHPLC

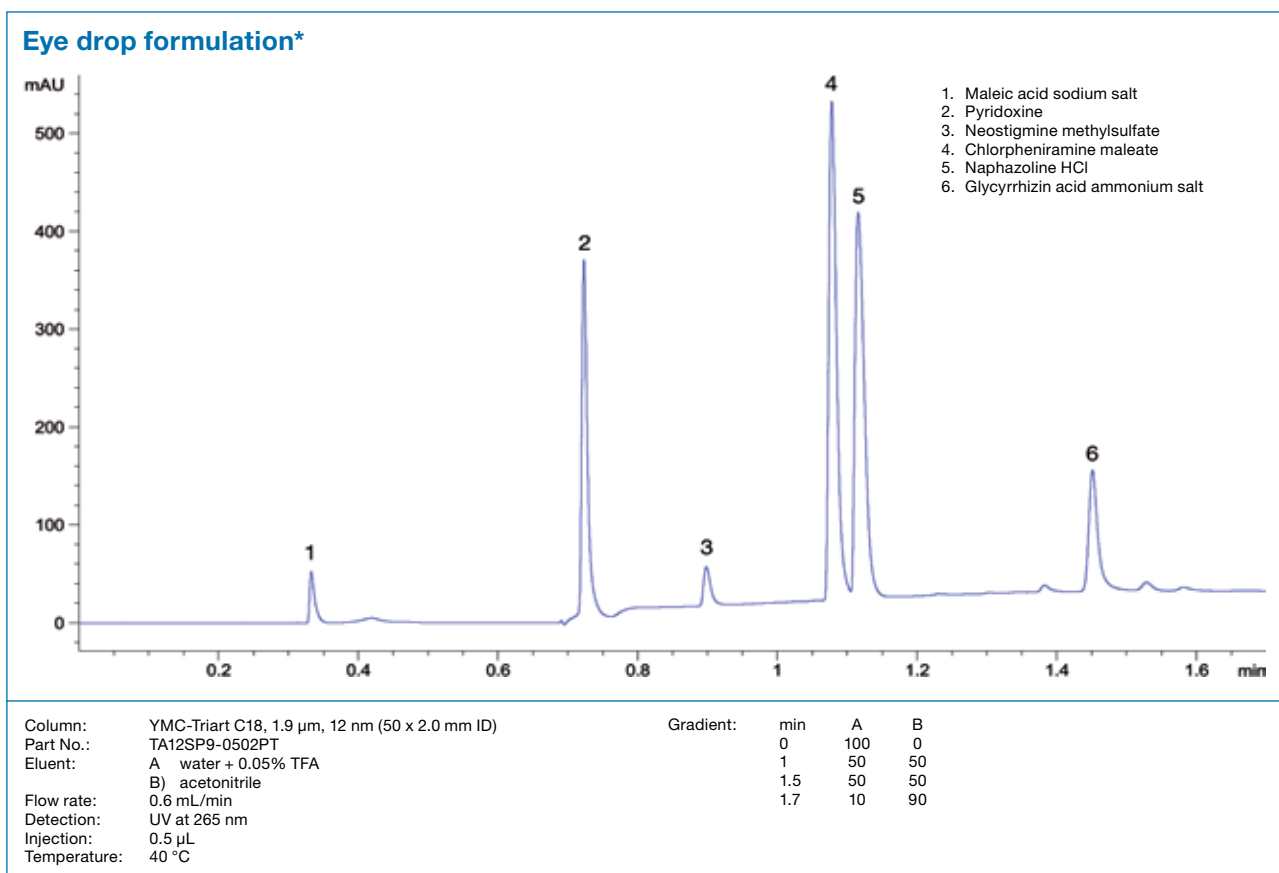
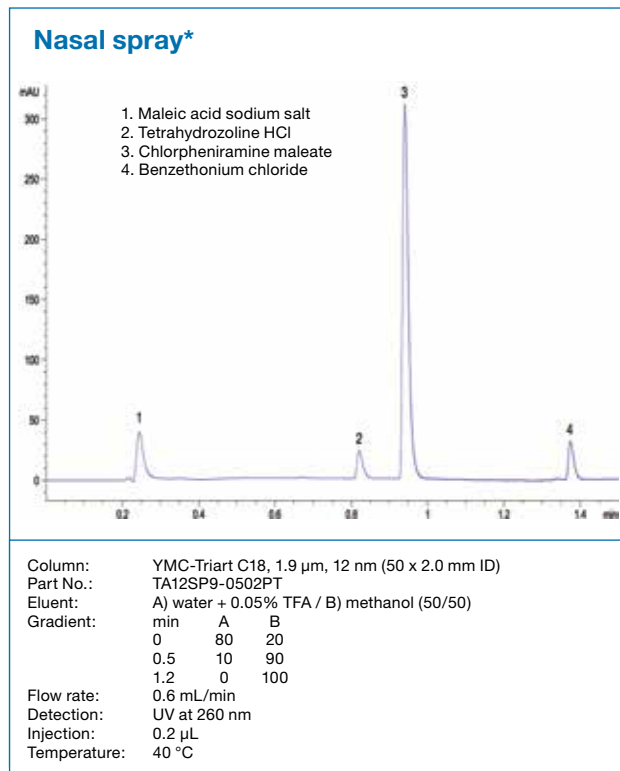
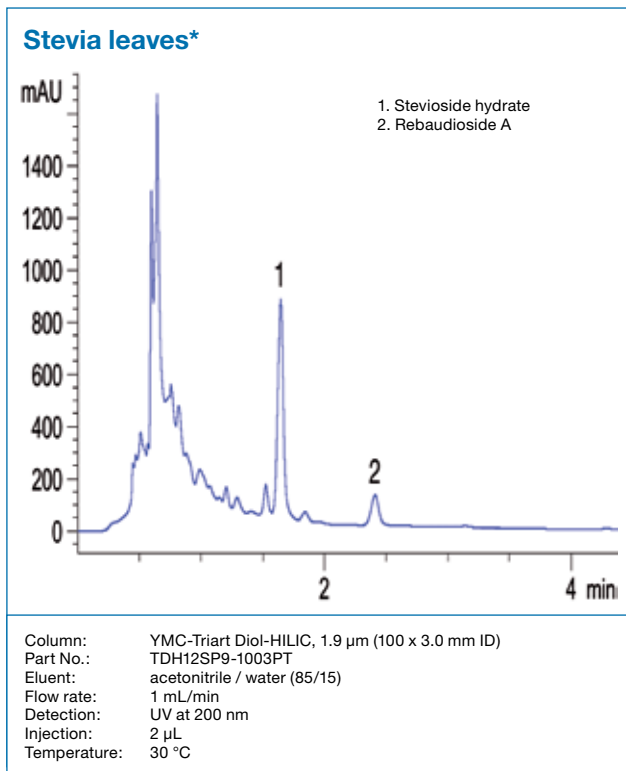

UHPLC

Guaiacol and impurities*

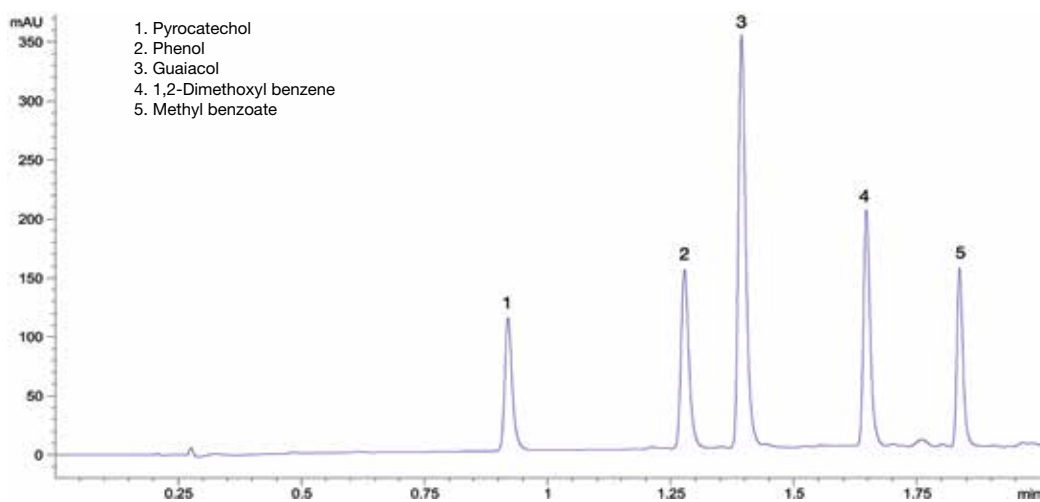

Column: YMC-Triart C18, 1.9 μ m, 12 nm (50 x 2.0 mm ID)
 Part No.: TA12SP9-0502PT
 Eluent: water / acetonitrile (50/50)
 Flow rate: 0.7 mL/min
 Detection: UV at 254 nm
 Injection: 0.5 μ L
 Temperature: 40 $^{\circ}$ C

Paracetamol*

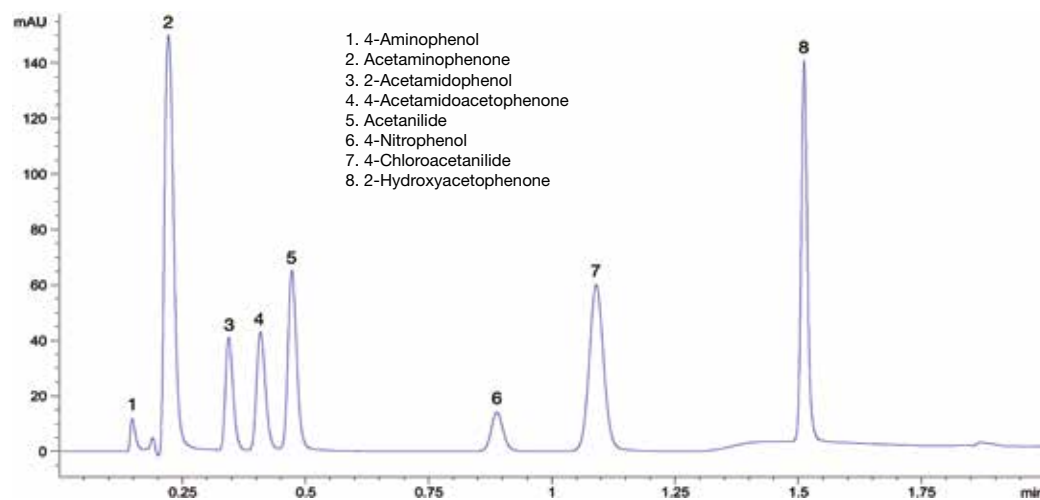

Column: YMC-Triart C18, 1.9 μ m, 12 nm (50 x 2.0 mm ID)
 Part No.: TA12SP9-0502PT
 Eluent: A) water + formic acid (pH 2.5) / B) acetonitrile
 Flow rate: 0.7 mL/min
 Detection: UV at 254 nm
 Injection: 0.5 μ L
 Temperature: 40 $^{\circ}$ C

Gradient:	min	A	B
	0	70	30
	1	70	30
	1.5	20	80
	2	20	80

7 Analgesics*

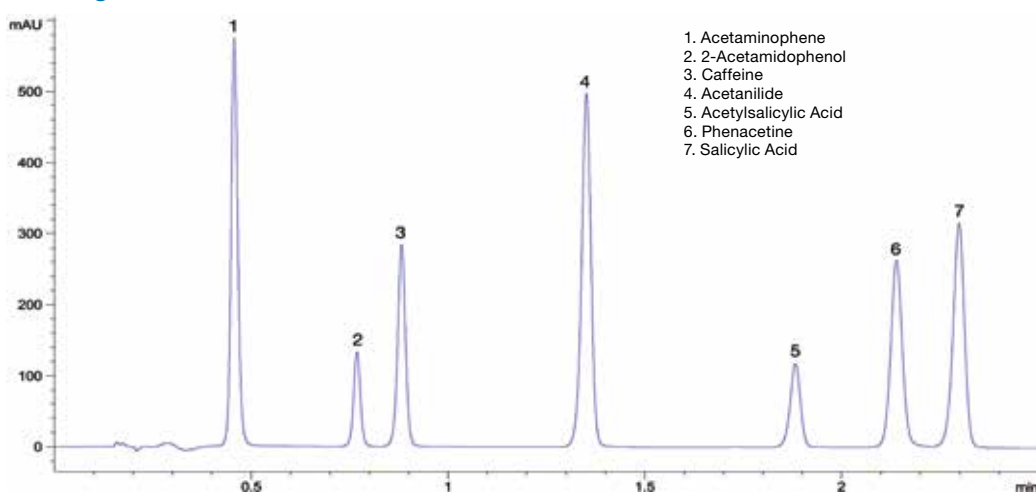

Column: YMC-Triart C18, 1.9 μ m, 12 nm (50 x 2.0 mm ID)
Part No.: TA12SP9-0502PT
Eluent: water + formic acid (pH 2.5) / acetonitrile (50/50)
Flow rate: 0.8 mL/min
Detection: UV at 240 nm
Injection: 1 μ L
Temperature: 40 $^{\circ}$ C

Hydroxychloroquine and chloroquine*

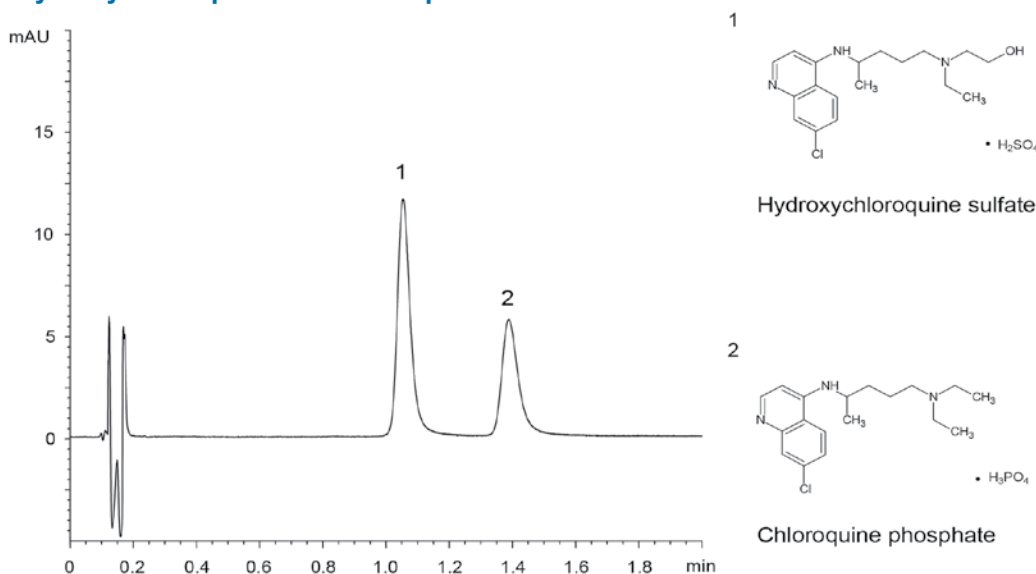

Column: YMC-Triart C18, 1.9 μ m, 12 nm (50 x 2.0 mm ID)
Part No.: TA12SP9-0502PT
Eluent: 20 mM HCOOH-HCOONH₄ (pH 4.3) / acetonitrile (90/10)
Flow rate: 1.0 mL/min
Detection: UV at 254 nm
Injection: 2 μ L (10 μ g/mL)
Temperature: 25 $^{\circ}$ C

UHPLC

Oligonucleotides d(T)₂₋₂₀ method transfer from HPLC to UHPLC*

Conventional LC method

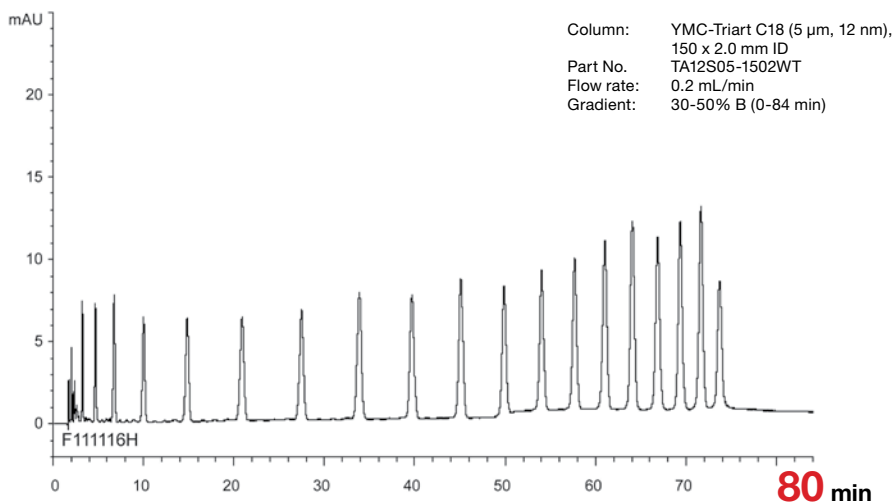

UHPLC method

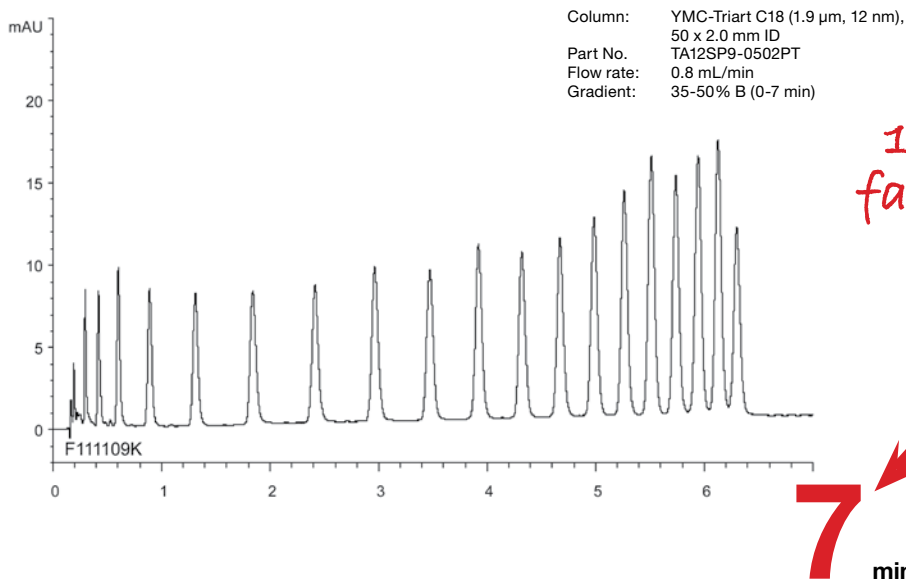

Eluent: A) 10 mM di-n-butylamine-acetic acid (pH 6.0)
B) methanol
Detection: UV at 269 nm
Injection: 1 μ L (5 nmol/mL)
Temperature: 37 $^{\circ}$ C

Duloxetine and its degradation products

(A) HPLC method

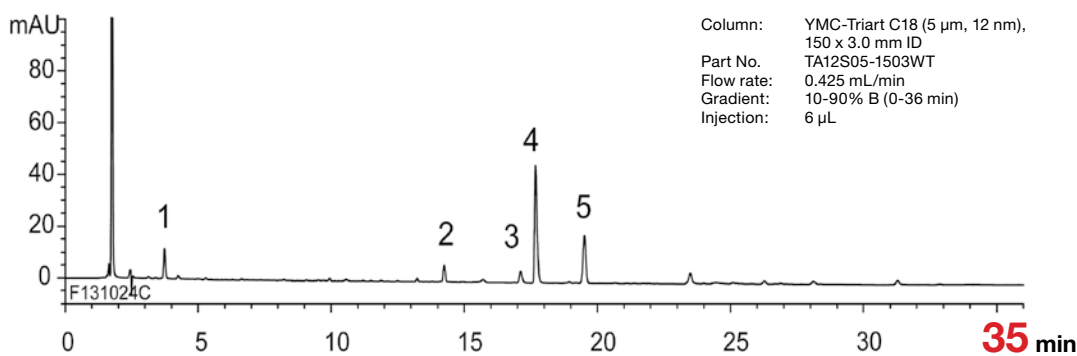

(B) UHPLC method

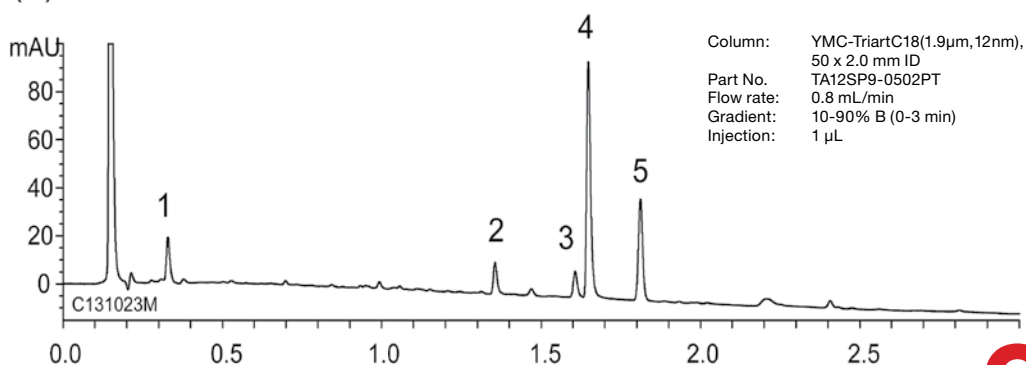

1.

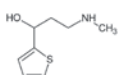

Amino alcohol

(3-Methylamino-1-thiophen-2-yl-propan-1-ol)

2.

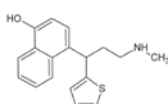

Para isomer

(4-(3-Methylamino-1-thiophen-2-yl-propyl)-naphthalen-1-ol))

3.

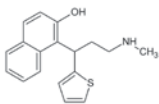

Ortho isomer

(2-(3-Methylamino-1-thiophen-2-yl-propyl)-naphthalen-1-ol)

4.

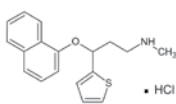

Duloxetine hydrochloride

5.

 α -Naphthol

Eluent: A) 10 mM CH₃COONH₄ (pH 6.0)
B) acetonitrile
Detection: UV at 230 nm
Temperature: 30 °C
Sample: Oxidative degradation products of duloxetine hydrochloride*

* Sample preparation was performed as described by Veera Reddy. Arava et al. Der Pharma Chemica, 2012 4 (4): 1735-1741

YMC-Triart C18 ExRS

Structural analogs*

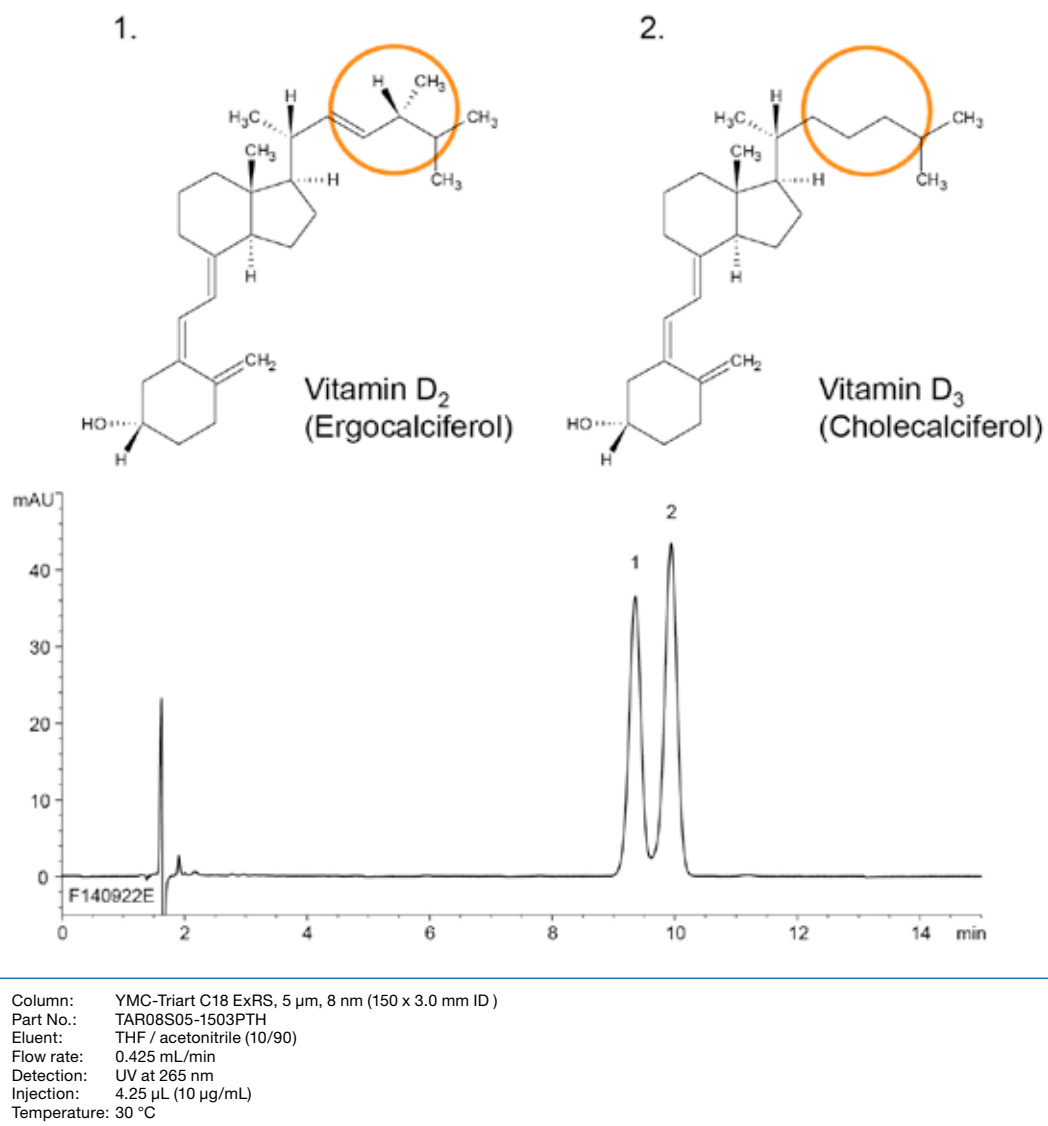

YMC-Triart C18 ExRS

High hydrophobicity & high steric recognition ability*

Basic Compound

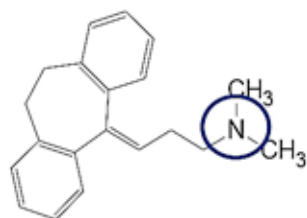

1. Amitriptyline

Coordination Compound

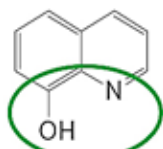

2. 8-Quinololinol

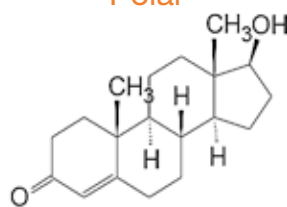
Neutral Compounds
Polar π - π interaction

3. Testosterone

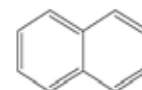

4. Naphthalene

Acidic Compound

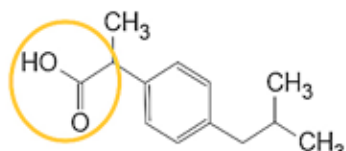

5. Ibuprofen

Hydrophobic

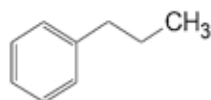
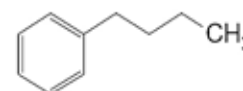
6. *n*-Propylbenzene7. *n*-Butylbenzene

Steric Cognitive Ability

8. *o*-Terphenyl (steric)

9. Triphenylene (planar)

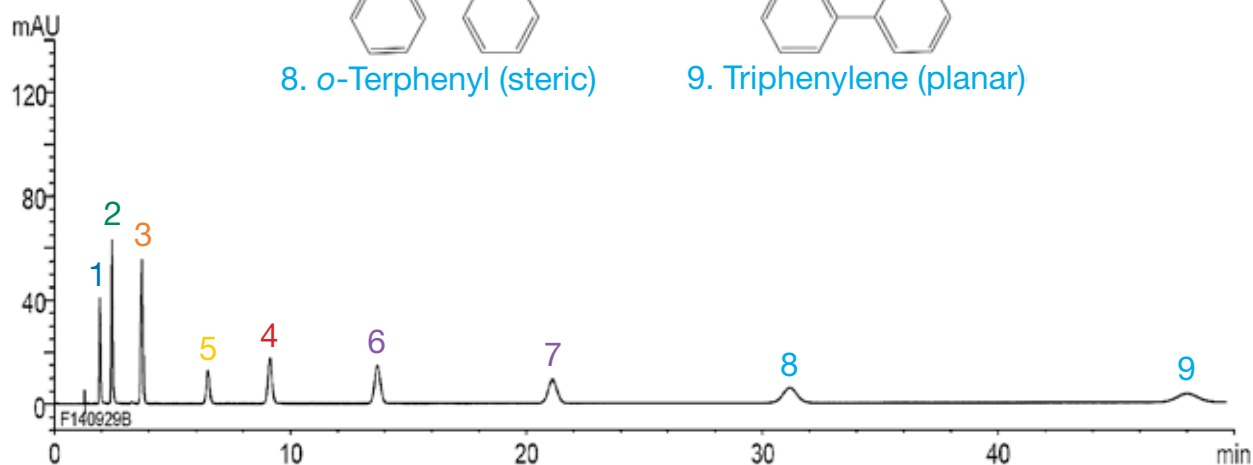

Column: YMC-Triart C18 ExRS, 5 μ m, 8 nm (150 x 3.0 mm ID)
 Part No.: TAR08S05-1503PTH
 Eluent: 20 mM HCOOH-HCOONH₄ (pH 4.3) / acetonitrile (90/10)
 Flow rate: 1.0 mL/min
 Detection: UV at 254 nm
 Injection: 2 μ L (10 μ g/mL)
 Temperature: 25 $^{\circ}$ C

YMC-Triart Phenyl

Fexofenadine hydrochloride (Japanese Pharmacopoeia)*

A) Standard solution *1 (0.001 mg/mL fexofenadine hydrochloride)

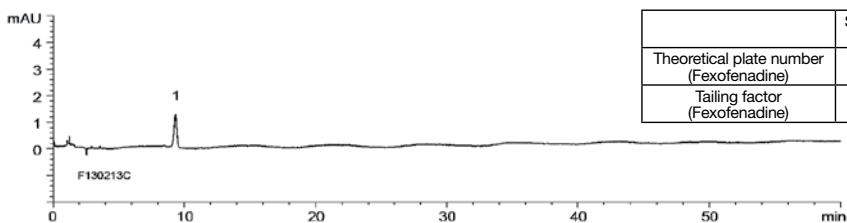

	System suitability requirement	result
Theoretical plate number (Fexofenadine)	≥ 8000	10100
Tailing factor (Fexofenadine)	≤ 2.0	1.00

B) Sample solution *1 (1 mg/mL fexofenadine hydrochloride)

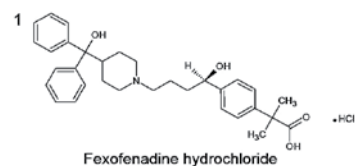
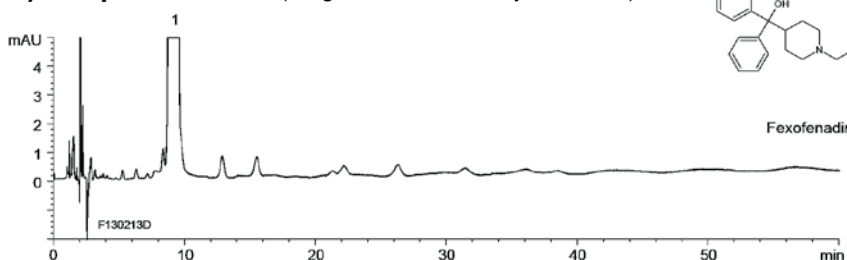

Column: YMC-Triart Phenyl, 5 μ m, 12 nm (250 x 4.6 mm ID)
 Part No.: TPH12S05-2546WT
 Eluent: acetonitrile / buffer *2 / triethylamine (350/650/3)
 *2 Dissolve 7.51 g of NaH₂PO₄·2H₂O and 0.96 g of NaClO₄·H₂O in 1000 mL water, adjust pH 2.0 with H₃PO₄
 Flow rate: 2.0 mL/min (adjust the flow rate so that the retention time of fexofenadine is about 9 min)
 Detection: UV at 220 nm
 Injection: 20 μ L
 Temperature: 25 °C
 (The Japanese Pharmacopoeia 16th; related substances)

*1 All standard and sample solutions were prepared from fexofenadine hydrochloride supplied as a reagent for laboratory use.

Fexofenadine hydrochloride (Japanese Pharmacopoeia)*

Standard solution *1 (0.06 mg/mL fexofenadine hydrochloride)

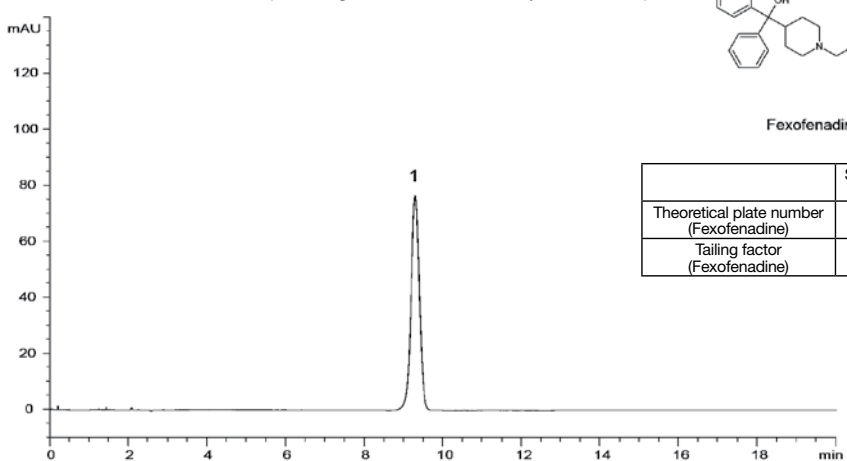

	System suitability requirement	result
Theoretical plate number (Fexofenadine)	≥ 8000	9500
Tailing factor (Fexofenadine)	≤ 2.0	0.98

Column: YMC-Triart Phenyl, 5 μ m, 12 nm (250 x 4.6 mm ID)
 Part No.: TPH12S05-2546WT
 Eluent: acetonitrile / buffer *2 / triethylamine (350/650/3)
 *2 Dissolve 7.51 g of NaH₂PO₄·2H₂O and 0.96 g of NaClO₄·H₂O in 1000 mL water, adjust pH 2.0 with H₃PO₄
 Flow rate: 2.0 mL/min (adjust the flow rate so that the retention time of fexofenadine is about 9 min)
 Detection: UV at 220 nm
 Injection: 20 μ L
 Temperature: 25 °C
 (The Japanese Pharmacopoeia 16th; assay)

*1 Standard solutions was prepared from fexofenadine hydrochloride supplied as a reagent for laboratory use.

YMC-Triart Phenyl

Fexofenadine hydrochloride (US Pharmacopoeia)*

A) Assay preparation *1 (assay), **Reference solution *1** (related compounds)
(0.06 mg/mL fexofenadine hydrochloride)

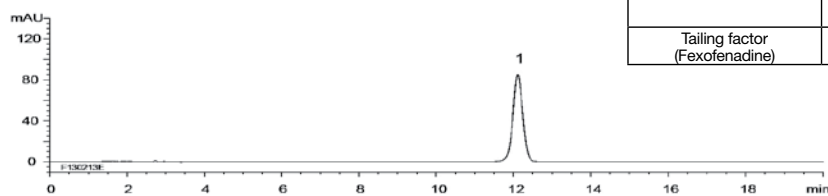

	System suitability requirement (assay)	result
Tailing factor (Fexofenadine)	≤ 2.0	1.00

B) Test solution *1 (related compounds)
(1 mg/mL fexofenadine hydrochloride)

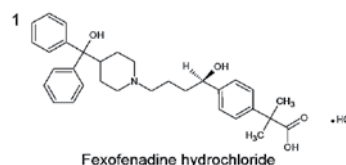
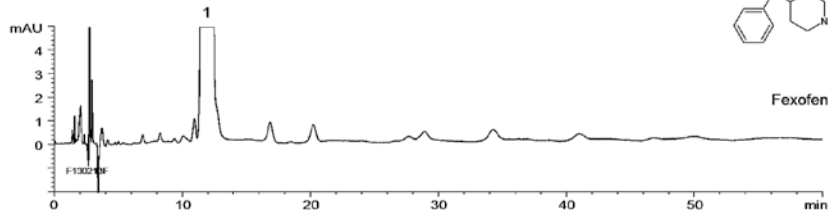

Column: YMC-Triart Phenyl, 5 μ m, 12 nm (250 x 4.6 mm ID)
Part No.: TPH12S05-2546WT
Eluent: acetonitrile / buffer *2 / triethylamine (350/650/3)
*2 Dissolve 7.51 g of $\text{NaH}_2\text{PO}_4 \cdot 2\text{H}_2\text{O}$ and 0.96 g of $\text{NaClO}_4 \cdot \text{H}_2\text{O}$ in 1000 mL water, adjust pH 2.0 with H_3PO_4
Flow rate: 1.5 mL/min
Detection: UV at 220 nm
Injection: 20 μ L
Temperature: 25 $^\circ\text{C}$
(The United States Pharmacopoeia 36th; assay, related compounds)

*1 All standard and sample solutions were prepared from fexofenadine hydrochloride supplied as a reagent for laboratory use.

Fexofenadine hydrochloride (US Pharmacopoeia)*

A) Standard solution *1 (0.015 mg/mL fexofenadine hydrochloride)

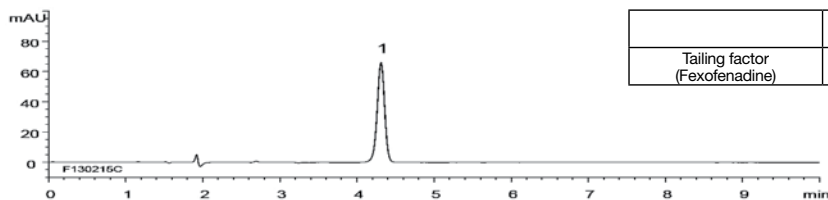

	System suitability requirement (assay)	result
Tailing factor (Fexofenadine)	≤ 2.0	0.95

B) Sample solution *2 (0.018 mg/mL fexofenadine hydrochloride)

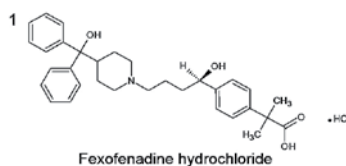
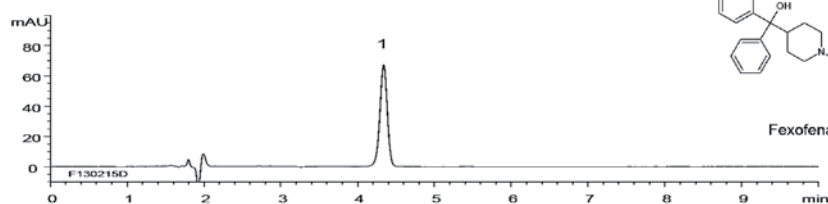

Column: YMC-Triart Phenyl, 5 μ m, 12 nm (250 x 4.6 mm ID)
Part No.: TPH12S05-2546WT
Eluent: acetonitrile / buffer *3 (9/16)
*3 Add 15 mL of acetonitrile/triethylamine (1/1) to 1000 mL of acetic acid/water (17/9983), adjust pH 5.25 with H_3PO_4
Flow rate: 1.5 mL/min
Detection: UV at 220 nm
Injection: 20 μ L
Temperature: 35 $^\circ\text{C}$
(The United States Pharmacopoeia 36th; assay)

*1 Standard solution was prepared from fexofenadine hydrochloride supplied as a reagent for laboratory use.

*2 Sample solution was prepared from fexofenadine hydrochloride tablets.

YMC-Triart Phenyl

Analysis of coal tar dye (Brilliant blue FCF) and its impurities*

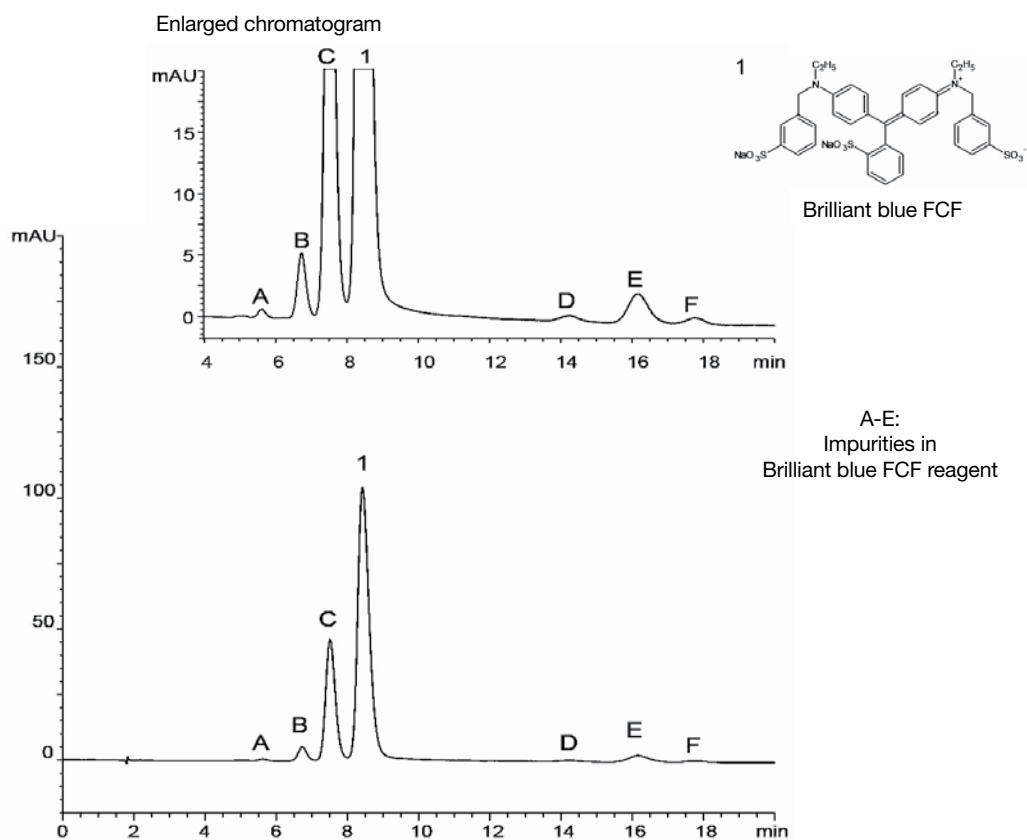

Column: YMC-Triart Phenyl, 5 μm , 12 nm (150 x 3.0 mm ID)
 Part No.: TPH12S05-1503WT
 Eluent: water + 0.1% phosphoric acid / methanol (55/45)
 Flow rate: 0.425 mL/min
 Detection: UV at 630 nm
 Injection: 2.0 μL
 Temperature: 40 $^{\circ}\text{C}$

YMC-Triart PFP

Catecholamines, serotonin, and their precursors and metabolites*

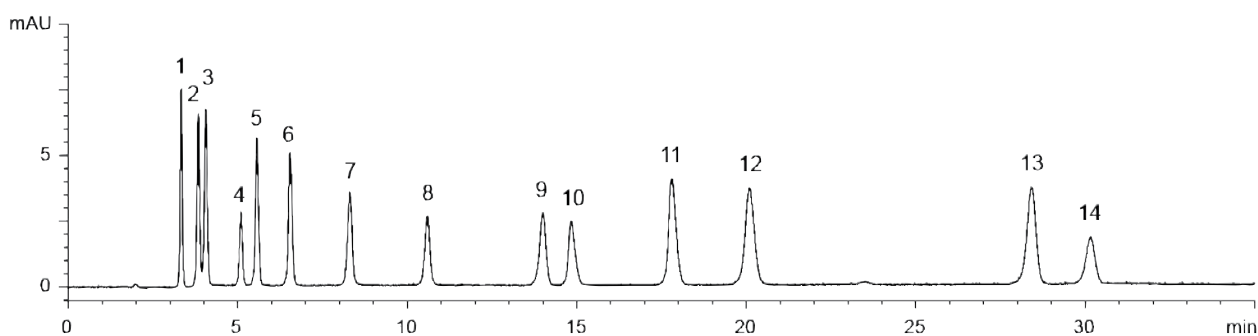

<p>1</p> <p>Noradrenaline hydrochloride (NA) (Norepinephrine hydrochloride)</p>	<p>2</p> <p>3,4-Dihydroxymandelic acid (DOMA)</p>	<p>3</p> <p>3,4-Dihydroxyphenylalanine (DOPA)</p>	<p>4</p> <p>Tyrosine (Tyr)</p>
<p>5</p> <p>Adrenaline hydrochloride (A) (Epinephrine hydrochloride)</p>	<p>6</p> <p>Dopamine hydrochloride (DA)</p>	<p>7</p> <p>Vanillylmandelic acid (VMA)</p>	<p>8</p> <p>3-Methoxy-4-hydroxyphenylglycol (MHPG)</p>
<p>9</p> <p>3,4-Dihydroxyphenylacetic acid (DOPAC)</p>	<p>10</p> <p>3-Methoxytyramine hydrochloride (3MT)</p>	<p>11</p> <p>Serotonin hydrochloride (5-Hydroxytryptamine hydrochloride, 5HT)</p>	<p>12</p> <p>Tryptophan (Trp)</p>
<p>13</p> <p>5-Hydroxyindoleacetic acid (5HIAA)</p>	<p>14</p> <p>Homovanillic acid (HVA)</p>		

Column: YMC-Triart PFP, 3 μ m, 12 nm (150 x 3.0 mm ID)
 Part No.: TPF12S03-1503WT
 Eluent: A) 10 mM formic acid
 B) methanol containing 10 mM formic acid
 0-20% B (0-30 min), 20% B (30-35 min)
 Flow rate: 0.425 mL/min
 Detection: UV at 280 nm
 Injection: 4 μ L (5 μ g/mL)
 Temperature: 25 $^{\circ}$ C

LC/MS

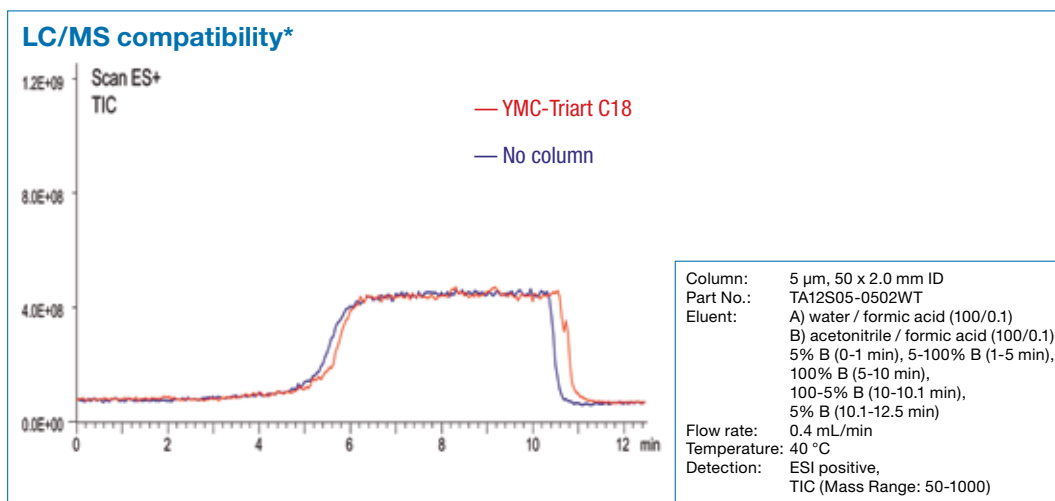

Column bleeding, caused by the fragments of stationary phase, is the main reason for background noise and restrictions on detection limits. No bleed is observed in the test of total ion current (TIC) measured by LC/MS with blank or with YMC-Triart C18. So in terms of the signal/noise ratio (S/N ratio), YMC-Triart C18 can be expected to not only reduce the background noise but to also increase the sensitivity of the analysis.

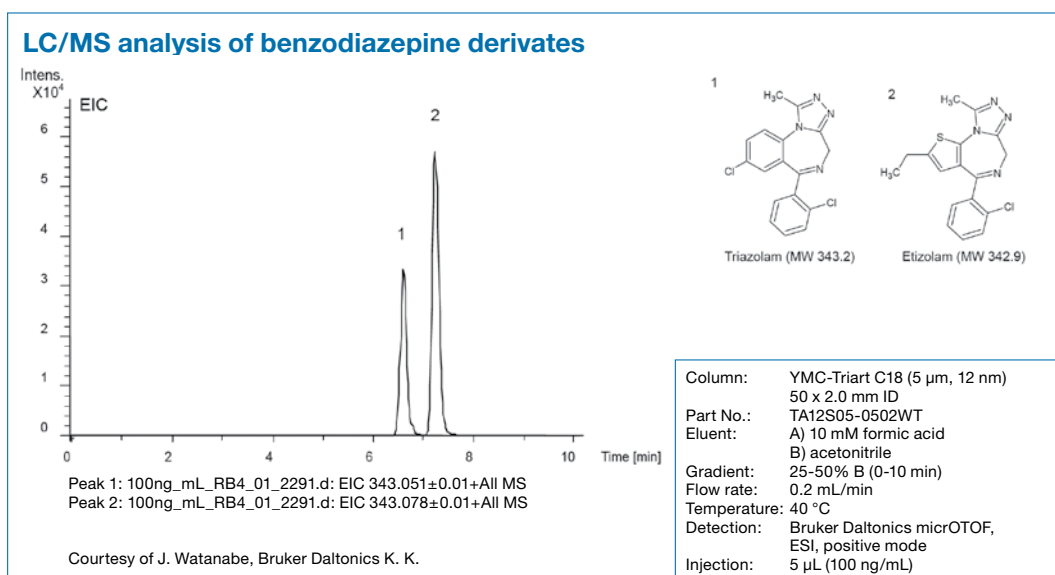

LC/MS analysis of tetracycline antibiotics*

A) UV

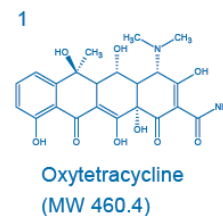
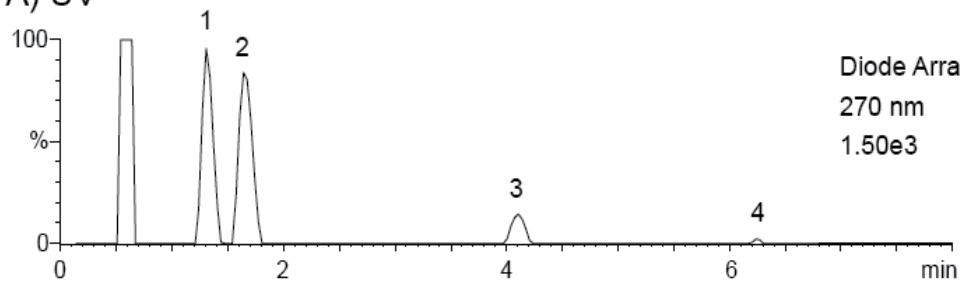

B) MS

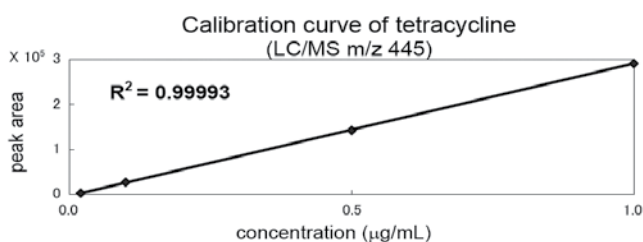
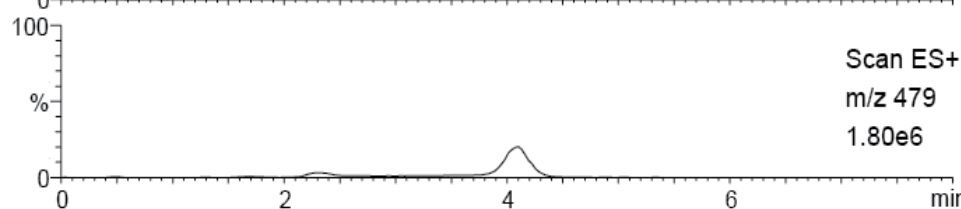
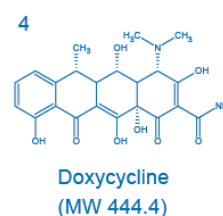
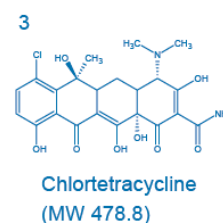
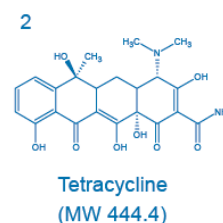
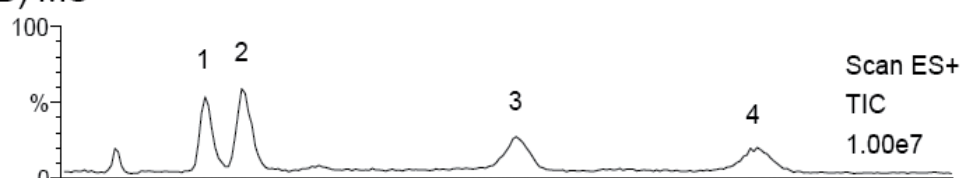

Column: YMC-Triart C18 (5 μm , 12 nm) 50 x 2.0 mm ID
Part No.: TA12S05-0502WT
Eluent: acetonitrile / water / formic acid (15/85/0.1)
Flow rate: 0.4 mL/min
Temperature: 40 $^{\circ}\text{C}$
Detection: A) UV at 270 nm
B) ESI positive-mode
Injection: 10 μL (1 $\mu\text{g/mL}$)

LC/MS

Analysis of 360 pesticides in a single run

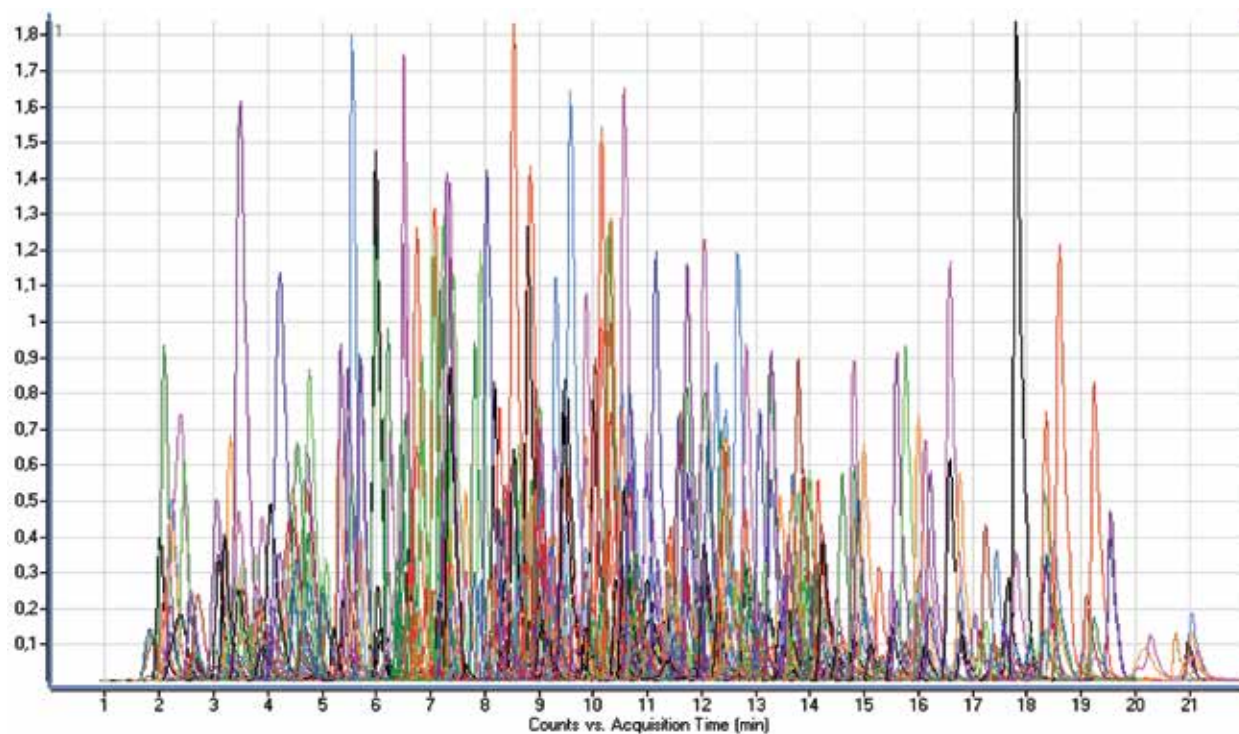

Column:	YMC-Triart C18 (3 μ m, 100 x 2.0 mm ID)	Injection:	5 μ L
Part No.:	TA12S03-1002WT	Gradient:	0 min: 30% B, 0.1 min: 50% B, 18 min: 100% B, 21 min: 100% B, 21.01 min: 30% B, 29 min: 30% B
Eluent:	A) 5 mM ammonium formate / water B) 5 mM ammonium formate / methanol	Total run time:	30 min
Flow rate:	0.25 mL/min	Sample:	100 ng/mL pesticide mix in acetonitrile
Temperature:	45 $^{\circ}$ C		

by courtesy of: József László
WIREC, WESSLING International Research and Educational Centre Nonprofit Co. (Hungary)

Pharmaceuticals

Separation of alkaloids*

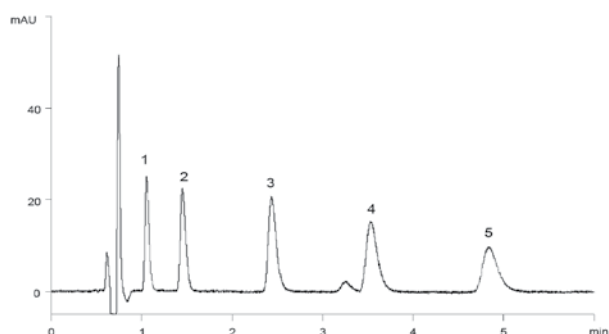

1. Scopolamine
2. Atropine
3. Cinchonine
4. Quinine
5. Dihydroquinine

Column: YMC-Triart C18 (5 μ m, 12 nm) 50 x 2.0 mm ID
 Part No.: TA12S05-0502WT
 Eluent: 20 mM CH₃COOH-CH₃COONH₄ (pH 4.9) / acetonitrile (80/20)
 Flow rate: 0.2 mL/min
 Temperature: 40 °C
 Detection: UV at 220 nm
 Injection: 1 μ L (0.02-0.1 mg/mL)

Barbiturates in human serum*

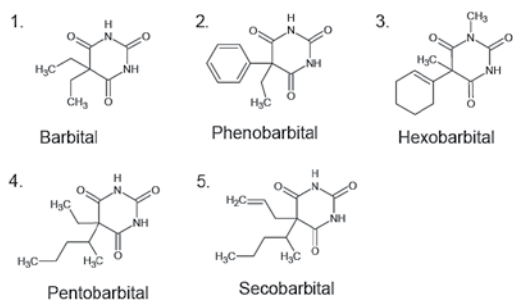
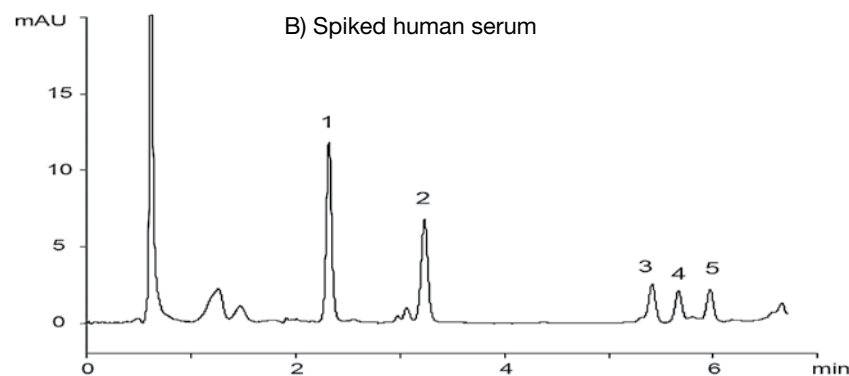
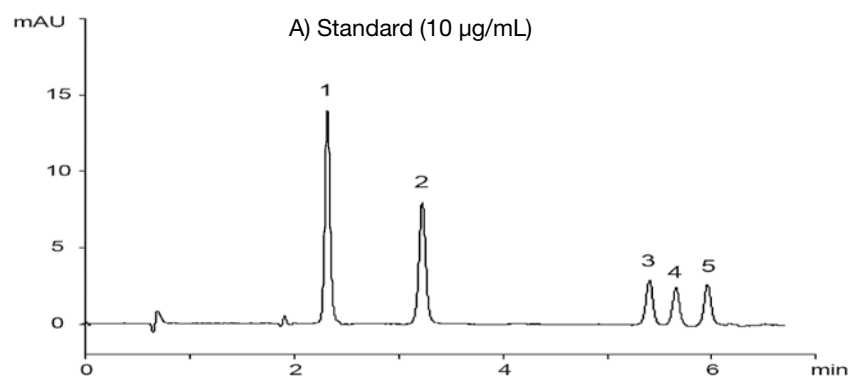

Solid-phase extraction method
 YMC Dispo SPE C18 100 mg/1mL

Condition

2 mL methanol
 2 mL water

Load

500 μ L spiked human serum
 solution (each 10 μ g)

Elute

500 μ L methanol/water (85/15)

Dilute

500 μ L 20 mM ammonium
 formate buffer (pH 9.5)

Column: YMC-Triart C18 (5 μ m, 12 nm) 50 x 2.0 mm ID
 Part No.: TA12S05-0502WT
 Eluent: A) 20 mM HCOONH₄-NH₃ (pH 9.5)
 B) methanol
 Gradient: 0-90% B (0-7 min)
 Flow rate: 0.2 mL/min
 Temperature: 25 °C
 Detection: UV at 240 nm
 Injection: 1 μ L

Pharmaceuticals

Erythromycin at elevated pH and temperature*

1. Optimisation of pH

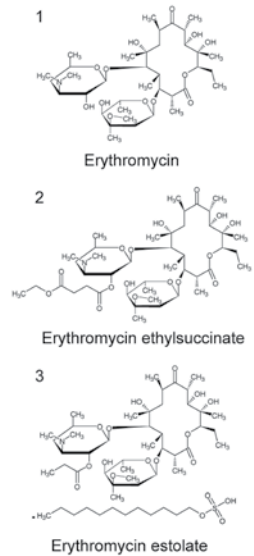
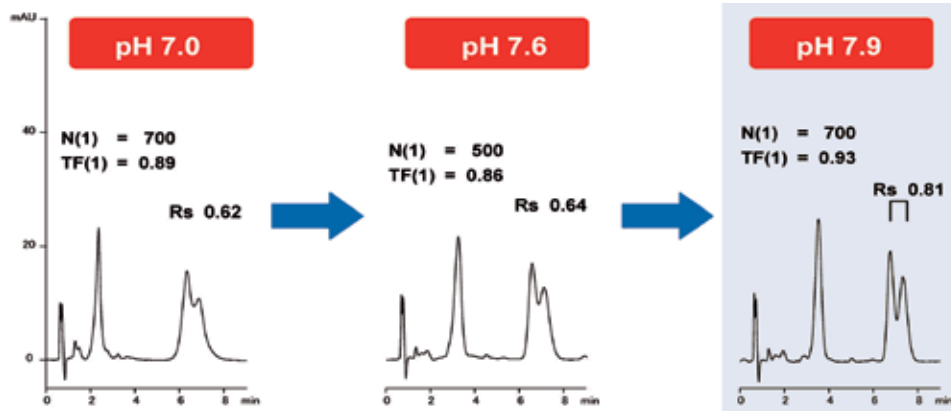

2. Optimisation of temperature (pH 7.9)

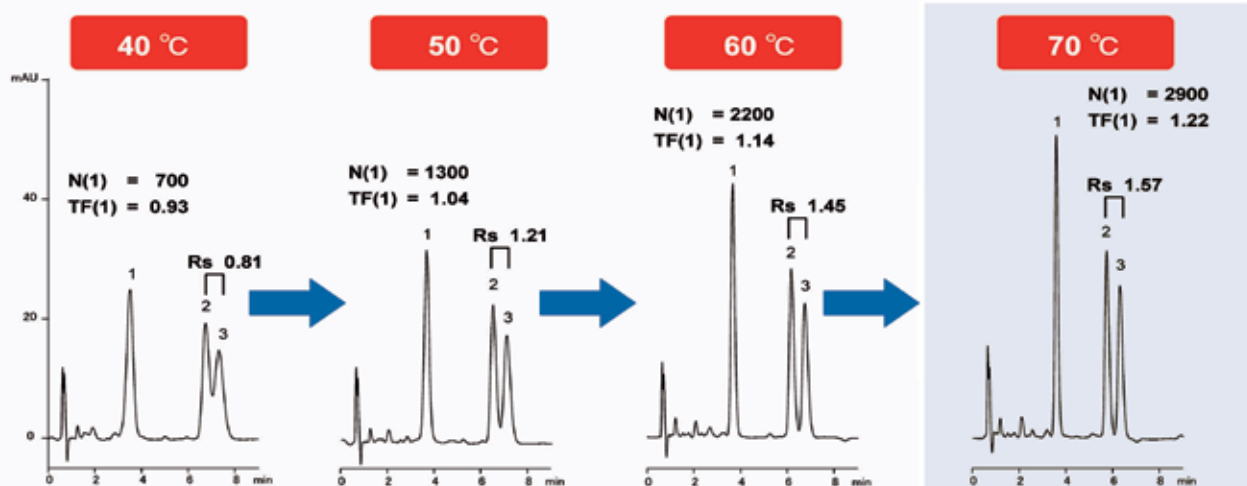

3. Stability test: pH 7.9, 70 °C

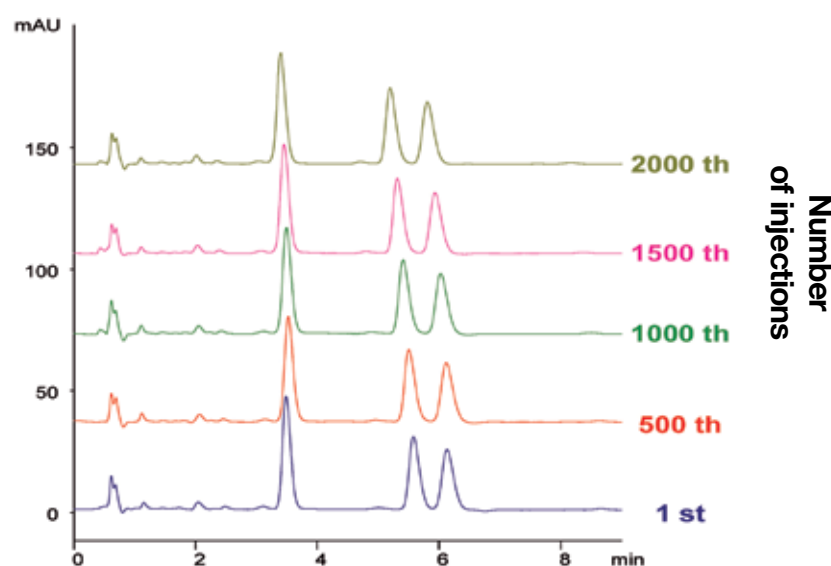

Column: YMC-Triart C18 (3 µm, 12 nm)
 Dimension: 50 x 2.0 mm ID
 Part No.: TA12S03-0502WT
 Eluent: 20 mM KH₂PO₄-K₂HPO₄ / acetonitrile / methanol (40/45/15)
 Flow rate: 0.2 mL/min
 Detection: UV at 210 nm

Pharmaceuticals

Separation of flavonoids*

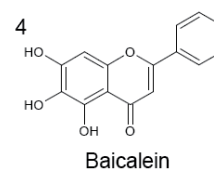
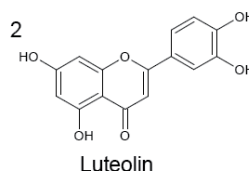
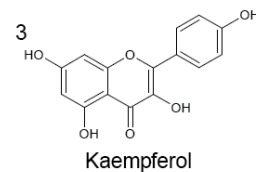
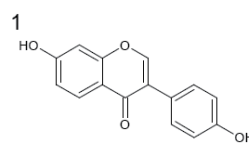
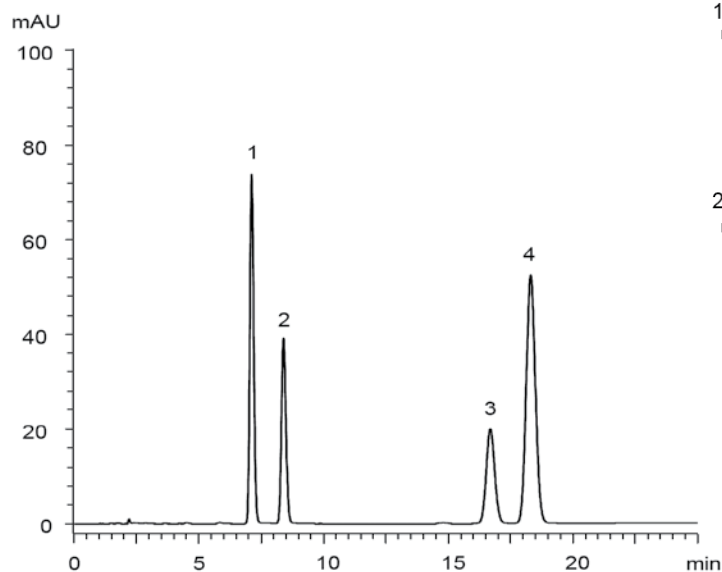

Column: YMC-Triart C18 (5 μ m, 12 nm)
 Dimension: 150 x 3.0 mm ID
 Part No.: TA12S05-1503WT
 Eluent: acetonitrile / 10 mM H₃PO₄ (30/70)
 Flow rate: 0.425 mL/min
 Temperature: 37 °C
 Detection: UV at 280 nm
 Injection: 2 μ L (50 μ g/mL)

Separation of aromatic carboxylic acids*

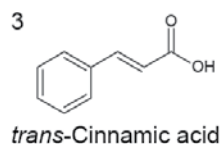
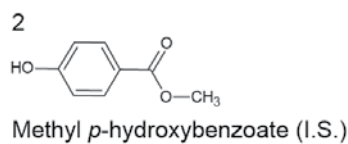
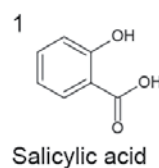
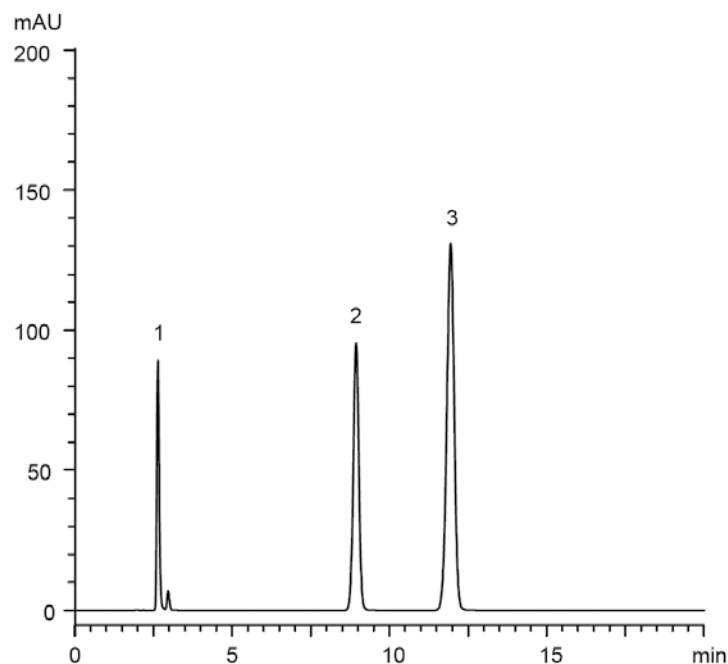

Column: YMC-Triart C18 (5 μ m, 12 nm)
 Dimension: 150 x 3.0 mm ID
 Part No.: TA12S05-1503WT
 Eluent: 10 mM CH₃COOH-CH₃COONH₄ (pH 4.2) / acetonitrile (75/25)
 Flow rate: 0.425 mL/min
 Temperature: 40 °C
 Detection: UV at 254 nm
 Injection: 4 μ L (0.02 ~ 0.3 mg/mL)

Pharmaceuticals

Aciclovir syrup and injection*

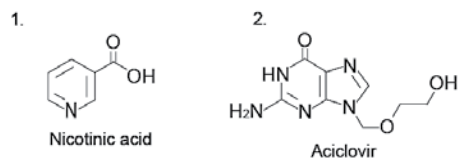
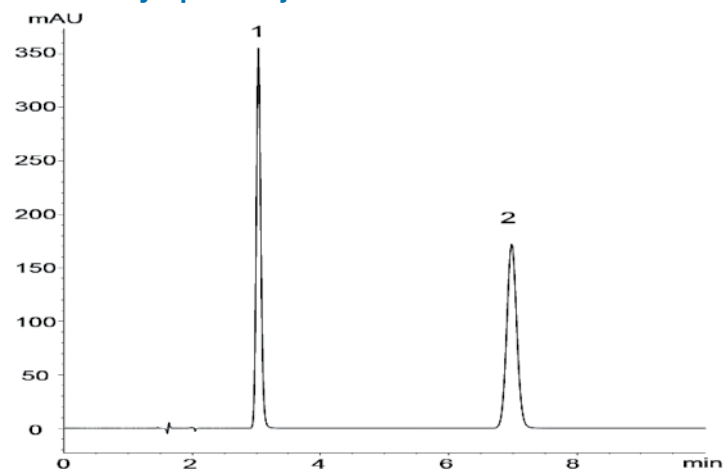

Column: YMC-Triart C18 (5 μ m, 12 nm) 150 x 4.6 mm ID
 Part No.: TA12S05-1546WT
 Eluent: phosphate buffer* / methanol (95/5)
 *Dissolve 1.45 g of H₃PO₄ and 25 mL of 1 mol/l CH₃COOH in water to make 900 mL \rightarrow adjust pH 2.5 by 1 mol/l NaOH \rightarrow add water to make 1000 mL
 Flow rate: 1.0 mL/min
 Temperature: 25 $^{\circ}$ C
 Detection: UV at 254 nm
 Injection: 20 μ L (0.05 mg/mL, 0.032 mg/mL)

Clindamycin hydrochloride*

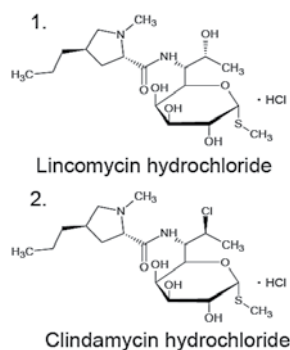
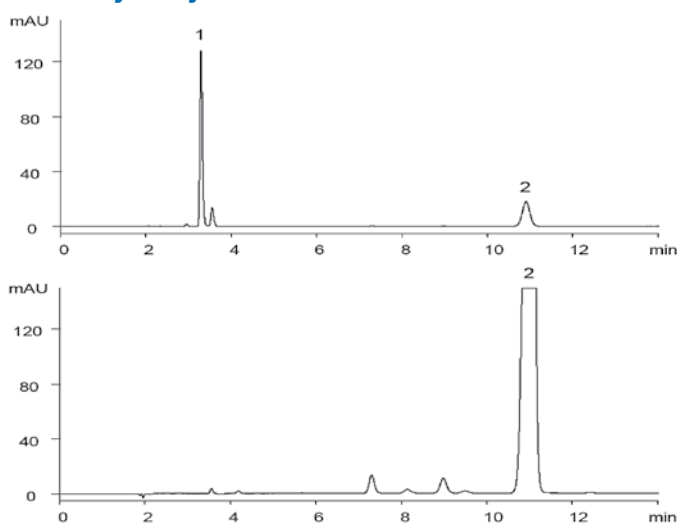

Column: YMC-Triart C18 (5 μ m, 12 nm) 250 x 4.6 mm ID
 Part No.: TA12S05-2546WT
 Eluent: 50 mM KH₂PO₄ (pH 7.5 adjusted by 8 M KOH) / acetonitrile (55/45)
 Flow rate: 1.0 mL/min
 Temperature: 25 $^{\circ}$ C
 Detection: UV at 210 nm
 Injection: 10 μ L

Analysis of amLodipine besilate*

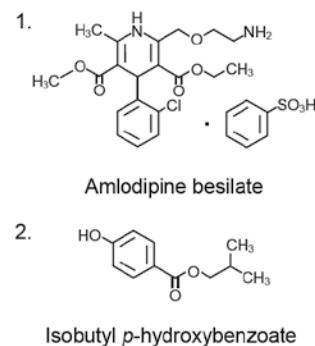
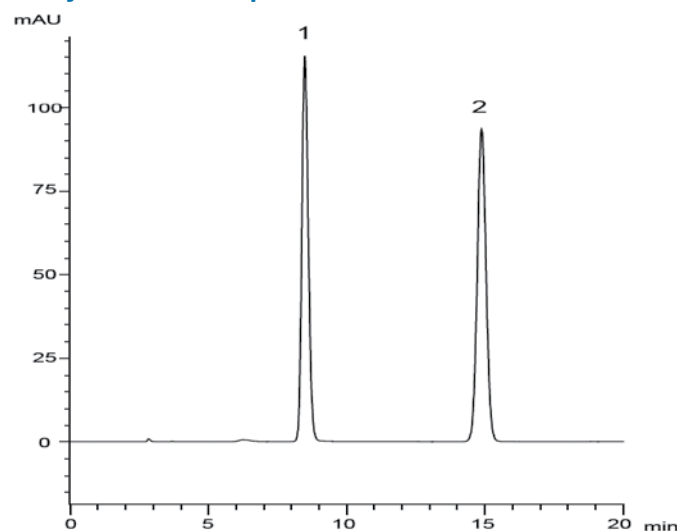

Column: YMC-Triart C18 (5 μ m, 12 nm) 150 x 3.0 mm ID
 Part No.: TA12S05-1503WT
 Eluent: 10 mM CH₃COOH-CH₃COONH₄ (pH 4.2) / acetonitrile (75/25)
 Flow rate: 0.425 mL/min
 Temperature: 40 $^{\circ}$ C
 Detection: UV at 254 nm
 Injection: 4 μ L (0.02 ~ 0.3 mg/mL)

Pharmaceuticals

Basic drugs*

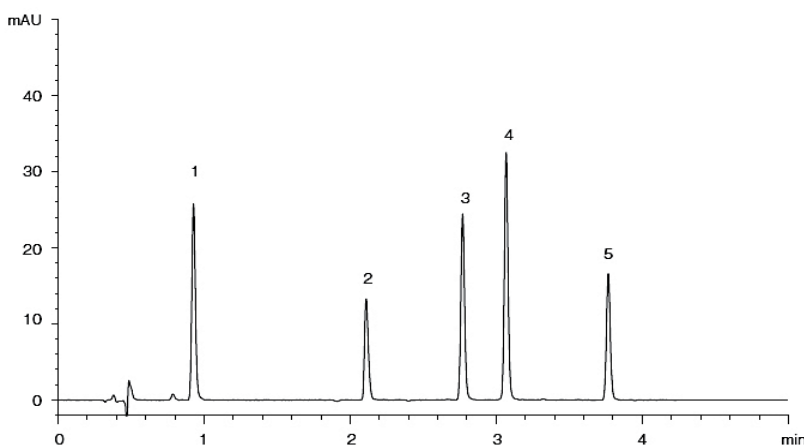

1. Hydrochlorothiazide
2. Amlodipine besilate
3. Valsartan
4. Atorvastatin calcium hydrate
5. Candesartan cilexetil

YMC-Triart C8

Column: YMC-Triart C8 (3 μ m, 12 nm), 50 x 2.0 mm ID
 Part No.: TO12S03-0502WT
 Eluent: A) water / formic acid (100/0.1)
 B) acetonitrile / formic acid (100/0.1)
 10-90% B (0-5 min), 90% B (5-7 min)

Flow rate: 0.4 mL/min
 Temperature: 30 $^{\circ}$ C
 Detection: UV at 254 nm
 Injection: 2 μ L (10-20 μ g/mL)

Sequential analysis of Carvedilol*

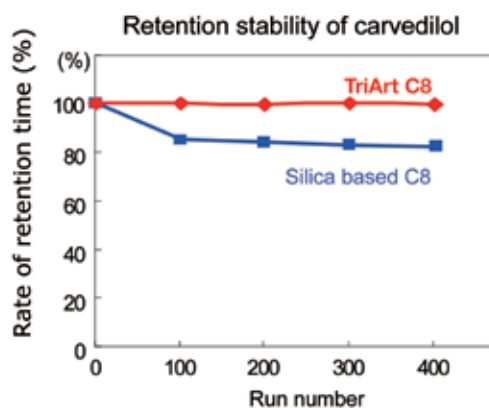
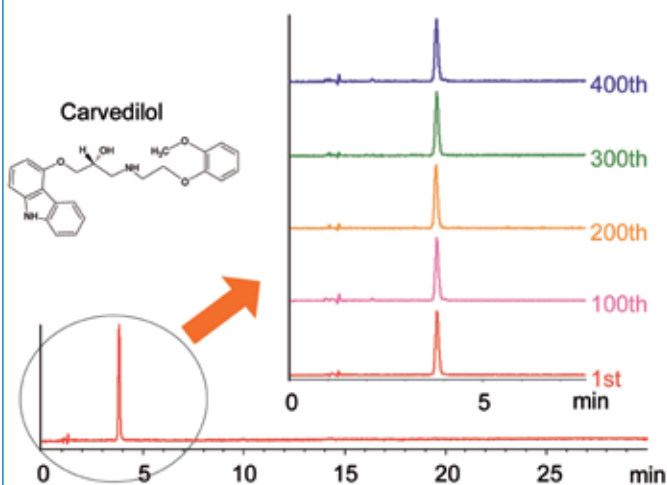

Column: YMC-Triart C8 (5 μ m, 150 x 2.0 mm ID)
 Part No.: TO12S05-1502WT
 Eluent: phosphate buffer (pH 2.0)* / acetonitrile (65/35)
 *Dissolve 2.72 g of KH_2PO_4 in 900 mL water, adjust pH 2.0 with H_3PO_4 and add water to make 1000 mL
 Flow rate: 0.28 mL/min (adjust the flow rate so that the retention time of carvedilol is about 4 min)
 Temperature: 55 $^{\circ}$ C
 Detection: UV at 240 nm

YMC-Triart C8

No change in retention time is observed even under a high pH and at an elevated temperature.

Food

Soy isoflavones in supplement*

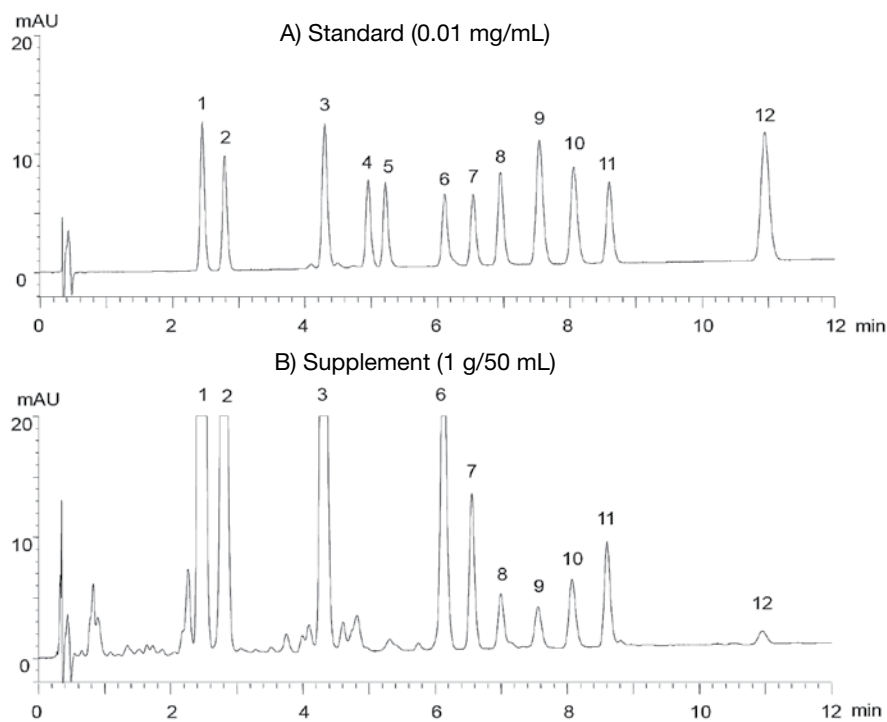

1. Daidzin
2. Glycitin
3. Genistin
4. 6"-O-Malonyldaidzin
5. 6"-O-Malonylglycitin
6. 6"-O-Acetyldaidzin
7. 6"-O-Acetylglycitin
8. 6"-O-Malonylgenistin
9. Daidzein
10. Glycitein
11. 6"-O-Acetylgenistin
12. Genistein

Sample preparation method

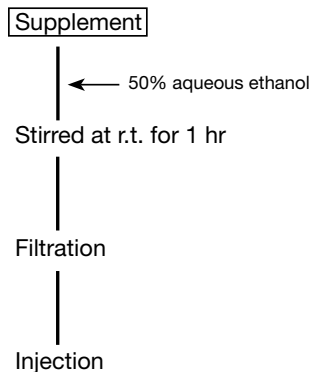

Column: YMC-Triart C18 (3 μ m, 12 nm)
50 x 2.0 mm ID
Part No.: TA12S03-0502WT
Eluent: A) acetonitrile / water / HCOOH (10/90/0.1)
B) acetonitrile / water / HCOOH (60/40/0.1)

Gradient: 5-40% B (0-12 min)
Flow rate: 0.4 mL/min
Temperature: 25 $^{\circ}$ C
Detection: UV at 254 nm
Injection: 2 μ L

Separation of water-soluble vitamins*

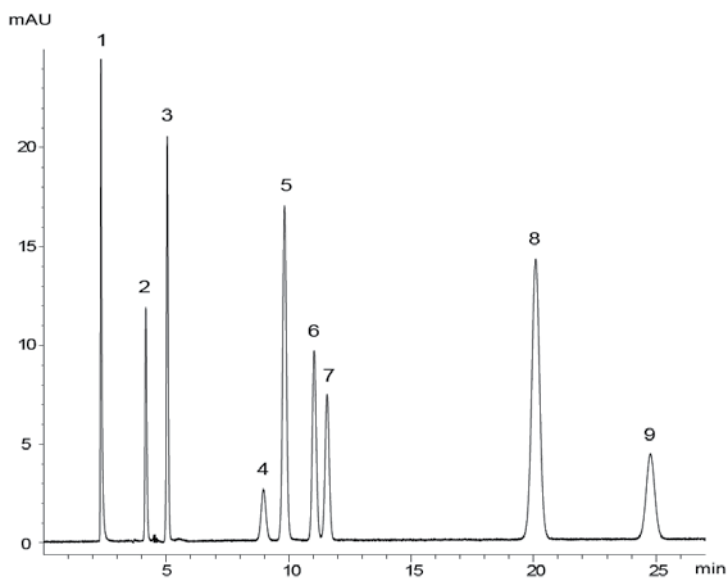

1. Thiamine HCl (Vitamin B₁)
2. Pyridoxine HCl (Vitamin B₆)
3. Nicotinamide
4. Cyanocobalamin (Vitamin B₁₂)
5. L-Ascorbic acid 2-glucoside
6. L-Ascorbic acid (Vitamin C)
7. Erythorbic acid
8. Riboflavin (Vitamin B₂)
9. Nicotinic acid

Column: YMC-Triart C18 (5 μ m, 12 nm) 250 x 4.6 mm ID
Part No.: TA12S05-2546WT
Eluent: phosphate buffer* / acetonitrile (90/10)
* Dissolve 1.4 g KH₂PO₄ in 800 mL water
→ add 26 mL 10% TBA·OH
→ adjust pH 5.2 by 20% H₃PO₄
→ add water to make 1000 mL
Flow rate: 0.8 mL/min
Temperature: 40 $^{\circ}$ C
Detection: UV at 260 nm
Injection: 10 μ L (5 μ g/mL)

Food

Analysis of anthocyanins and anthocyanidins*

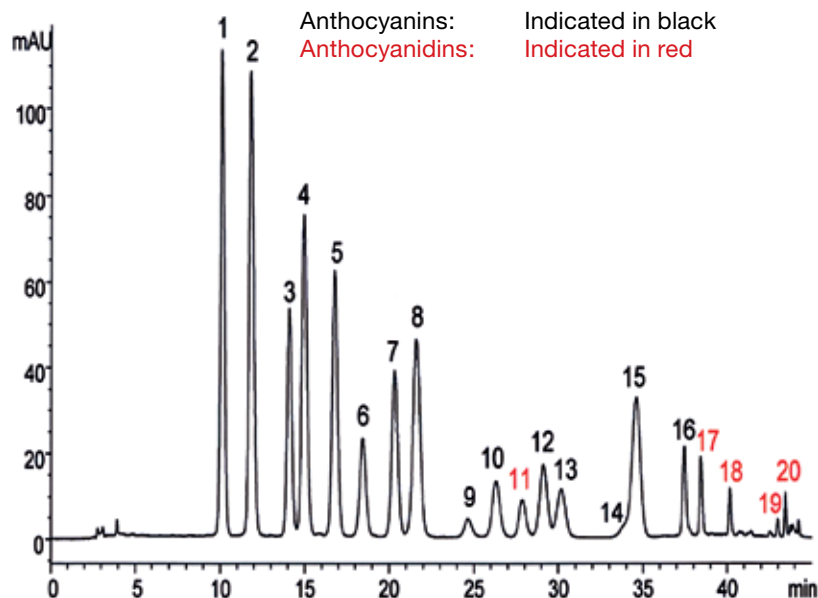

1. Delphinidin-3-O-galactoside
2. Delphinidin-3-O-glucoside
3. Cyanidin-3-O-galactoside
4. Delphinidin-3-O-arabinoside
5. Cyanidin-3-O-glucoside
6. Petunidin-3-O-galactoside
7. Cyanidin-3-O-arabinoside
8. Petunidin-3-O-glucoside
9. Peonidin-3-O-galactoside
10. Petunidin-3-O-arabinoside
11. Delphinidin
12. Peonidin-3-O-glucoside
13. Malvidin-3-O-galactoside
14. Peonidin-3-O-arabinoside
15. Malvidin-3-O-glucoside
16. Malvidin-3-O-arabinoside
17. Cyanidin
18. Petunidin
19. Peonidin
20. Malvidin

Column: YMC-Triart C18 (5 μ m, 12 nm)
 Dimension: 250 x 4.6 mm ID
 Part No.: TA12S05-2546WT
 Eluent: A) water / formic acid (90/10)
 B) acetonitrile / methanol / water / formic acid (22.5/22.5/40/10)
 Gradient: 20-28% B (0-30 min),
 28-70% B (30-40 min),
 100% B (40-45 min)
 Flow rate: 1.0 mL/min
 Temperature: 25 $^{\circ}$ C
 Detection: UV/VIS at 535 nm
 Sample: commercial bilberry powder (1.25 mg/mL)

Peptides

Peptides (MW 556 - 3,465)*

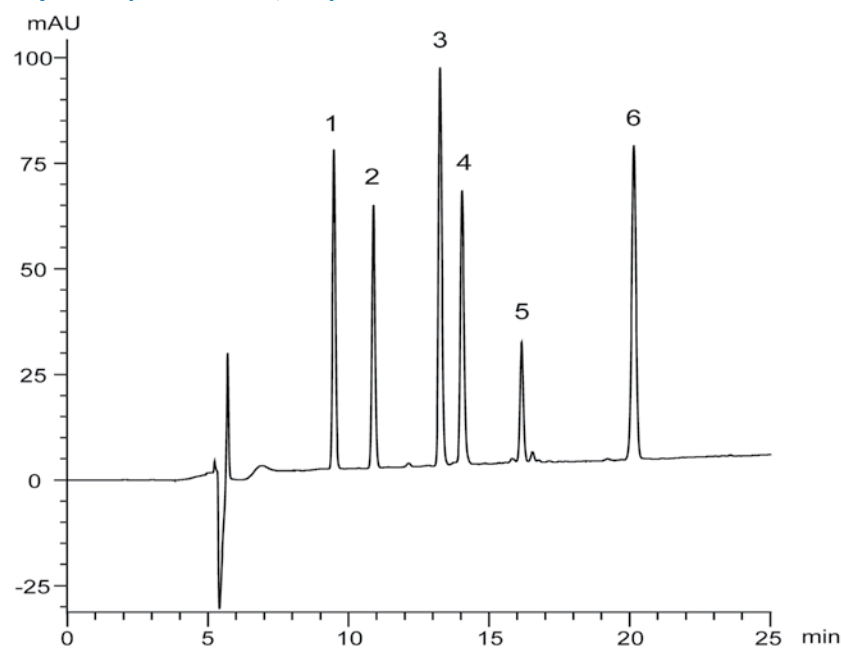

- | | |
|------------------------|------------|
| 1. Oxytocin | (MW 1,007) |
| 2. Met-Enkephalin | (MW 574) |
| 3. Leu-Enkephalin | (MW 556) |
| 4. Neurotensin | (MW 1,673) |
| 5. γ -Endorphin | (MW 1,859) |
| 6. β -Endorphin | (MW 3,465) |

Column: YMC-Triart C18 (5 μ m, 12 nm)
 Dimension: 150 x 2.0 mm ID
 Part No.: TA12S05-1502WT
 Eluent: A) water / TFA (100/0.1)
 B) acetonitrile / TFA (100/0.1)
 20-45% B (0-25 min)
 Flow rate: 0.2 mL/min
 Temperature: 37 $^{\circ}$ C
 Detection: UV at 220 nm
 Injection: 2 mL (0.075 ~ 0.25 mg/mL)

YMC-Triart "AQ"

YMC-Triart C18

General

The use of 100% water eluent has been a challenge in HPLC analysis for decades. Even today, many C18 materials suffer from unacceptable short lifetime, because the C18 chains collapse and this reduces the separation performance drastically. As a pioneer in this field, YMC has offered a product as early as the 80's, which presents a synonym for stability under aqueous conditions:

YMC-Pack ODS-AQ.

"AQ"-type phases are particularly suitable for the separation of polar substances, metabolites, pesticides, degradation products and peptides including protein digests.

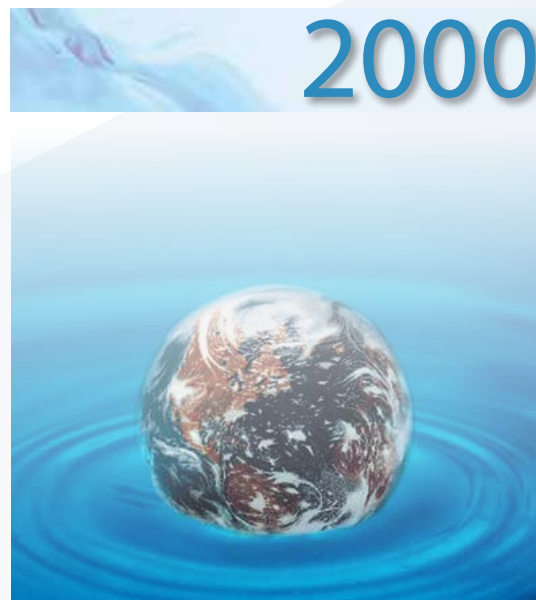

YMC-Pack ODS-AQ

- "hydrophilic" C18
- balanced surface chemistry
- polar recognition
- metabolite recognition

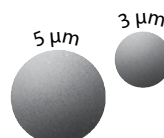

YMC-Triart "AQ"

YMC-Triart C18

2013



Hydrosphere C18

A new, ultrapure silica base was introduced whilst adapting the surface chemistry to maintain the "AQ"-type properties.

- "hydrophilic" C18 surface for enhanced polar recognition
- stable when used with 100% aqueous eluent
- no need for ion pair reagents
- addition of 2 μm particle size for Fast-LC (YMC-Pack UltraHT)

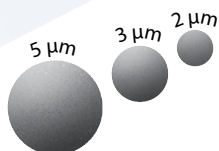

YMC-Triart "AQ" = YMC-Triart C18

The latest YMC technology platform consists of a "hybrid-style" substrate with enhanced stability against

- pH 1-12
- temp. up to 70°C
- 100% H₂O

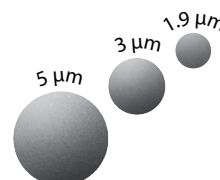

Therefore, YMC-Triart provides freedom in method development, robustness and enhanced column lifetimes for reproducible results, day after day, year after year. YMC-Triart is fully scalable within (U)HPLC \leftrightarrow HPLC with its 1.9 – 3 – 5 micron particle sizes in order to facilitate lab-to-lab method transfer.

YMC-Triart "AQ"

YMC-Triart C18

Problem with conventional C18 columns

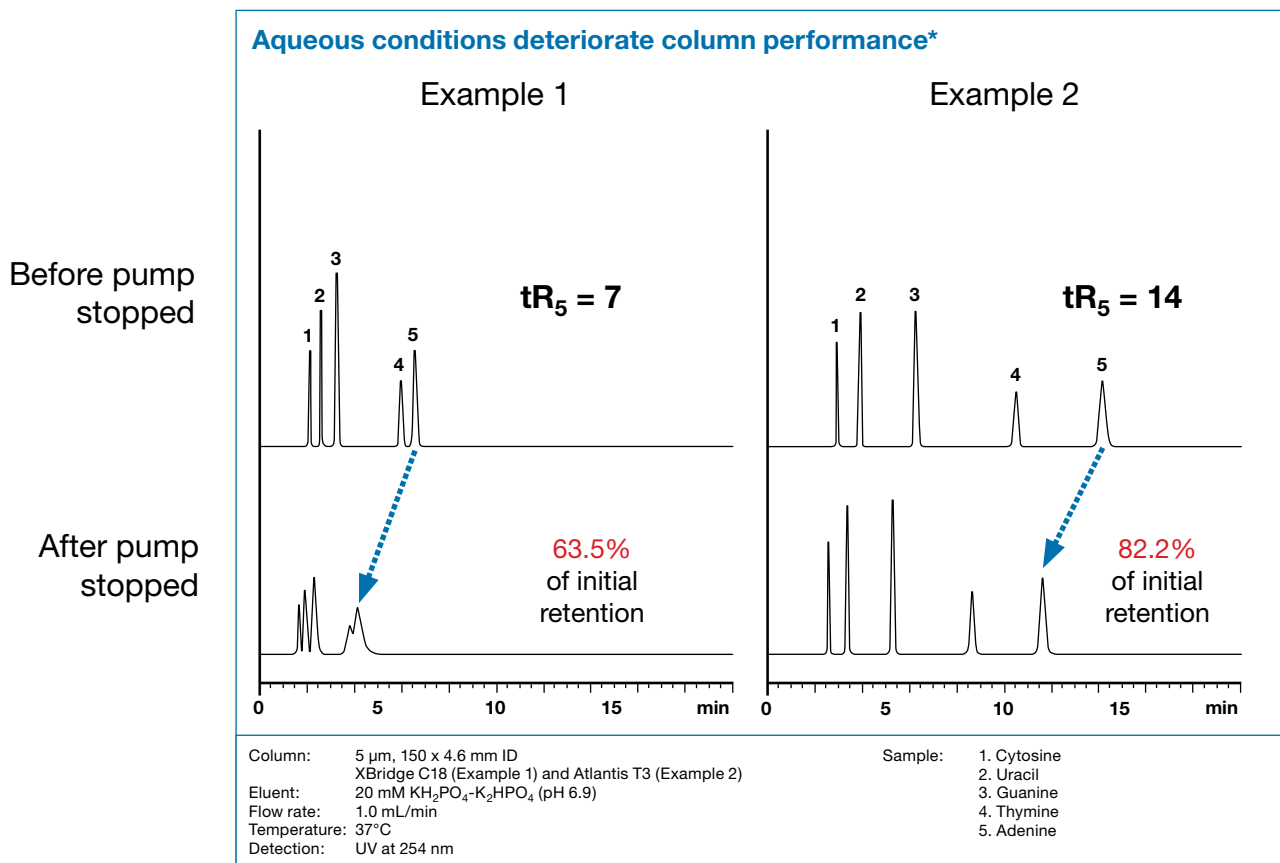
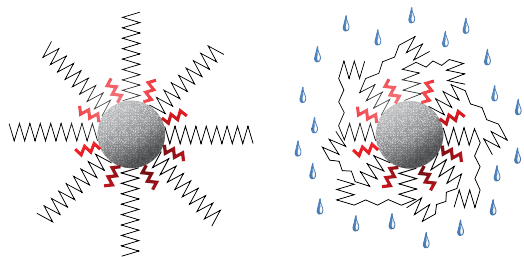
**Why?** Image of C18 surface hydration

The columns used for applications involving 100% aqueous buffers provide shorter retention times after the flow was stopped between analyses.

This behaviour is caused by poor hydration of the phase. Polar compounds cannot easily distribute between the mobile phase and the stationary phase.

YMC-Triart "AQ"

YMC-Triart C18

Solution with YMC-Triart C18

Reproducible stable performance!*

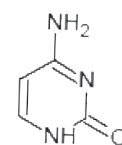
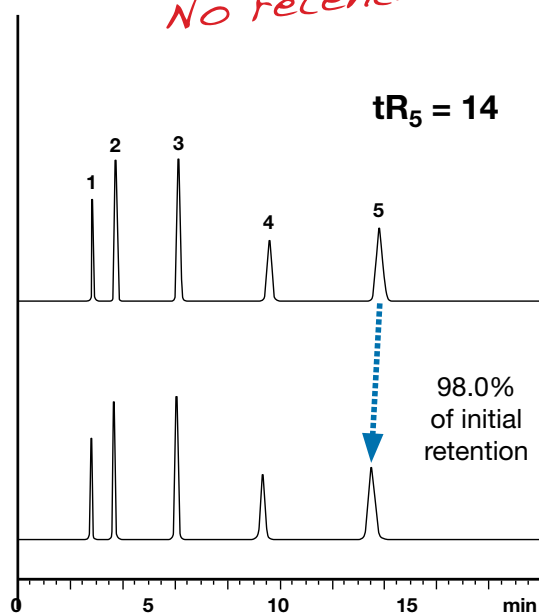
*No retention time changes!*Before pump
stoppedAfter pump
stopped

1. Cytosine

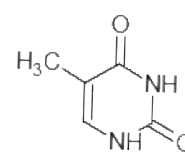

4. Thymine

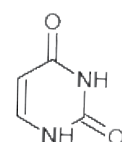

2. Uracil

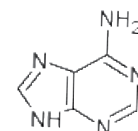

5. Adenine

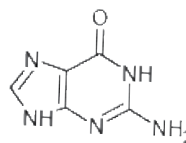

3. Guanine

Column: YMC-Triart C18, (5 μ m, 12 nm) 150 x 4.6 mm ID
 Part No.: TA12S05-1546WT
 Eluent: 20 mM KH_2PO_4 - K_2HPO_4 (pH 6.9)
 Flow rate: 1.0 mL/min
 Temperature: 37°C
 Detection: UV at 254 nm

Image of C18 surface hydration

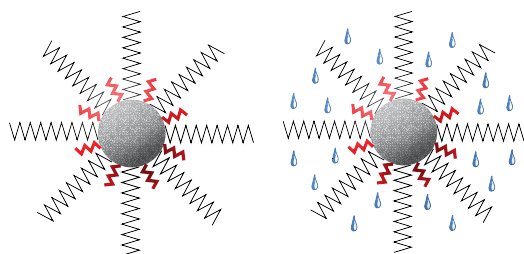

When Triart C18 columns are used for applications involving 100% aqueous buffers, the retention times are unchanged after the flow was stopped between analyses.

This is due to the improved hydration of the phase. Polar compounds can easily distribute between the mobile phase and the stationary phase.

YMC-Triart "AQ"

YMC-Triart C18

From the inventors of AQ-columns:
YMC-Triart C18 "validated" for AQ-conditions!*

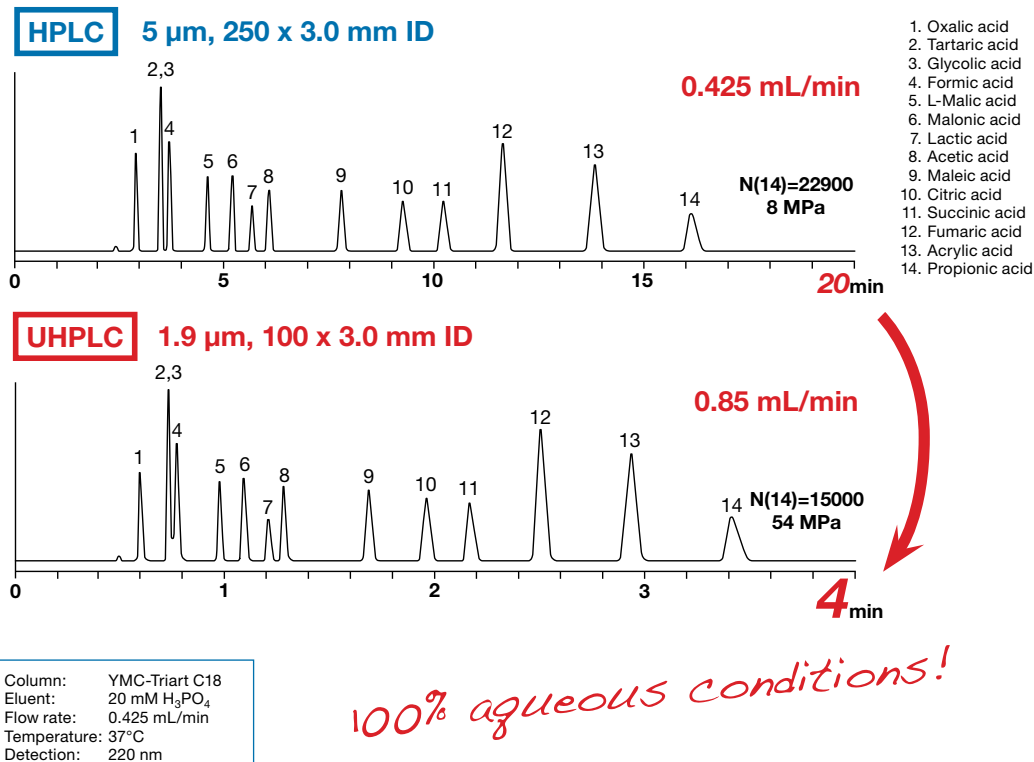

Stable under harsh conditions: pH 1-12 and temperature up to 70°C.
Stable retention times with 100% aqueous eluents!
Reproducible results day after day, column to column and lab to lab!

YMC-Triart "AQ"

YMC-Triart C18

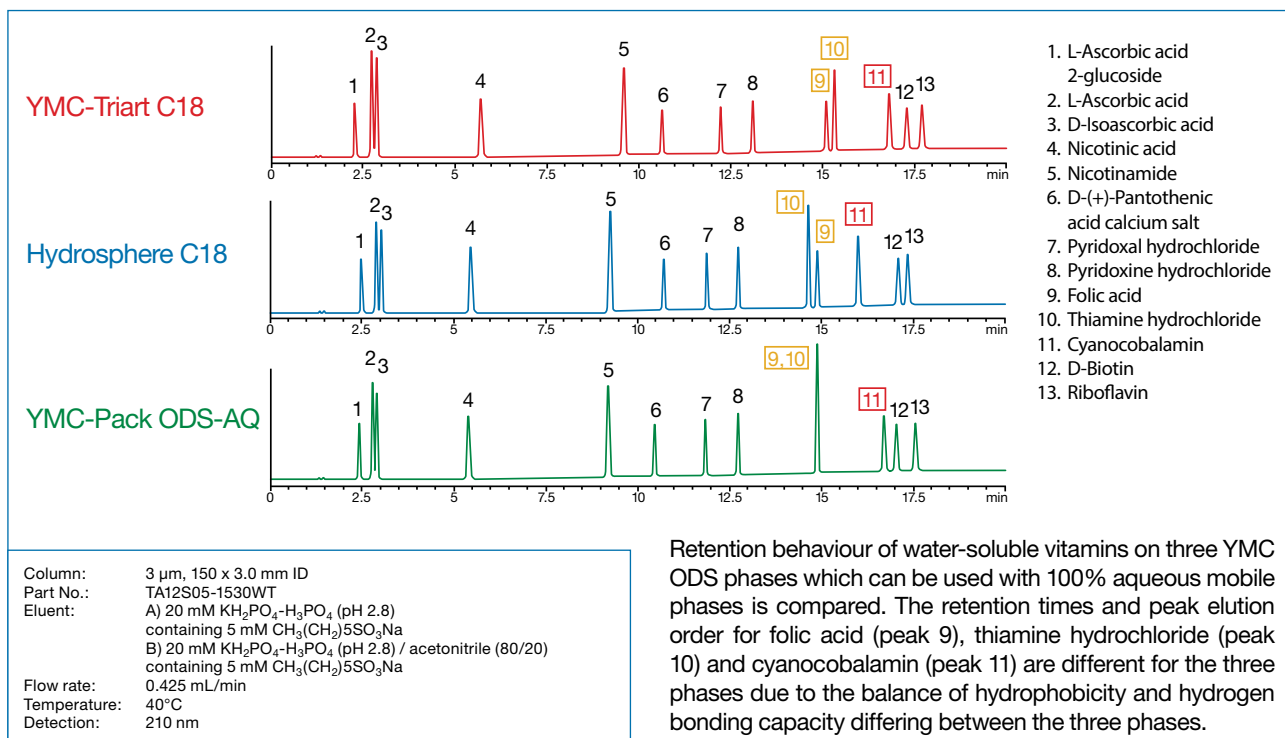
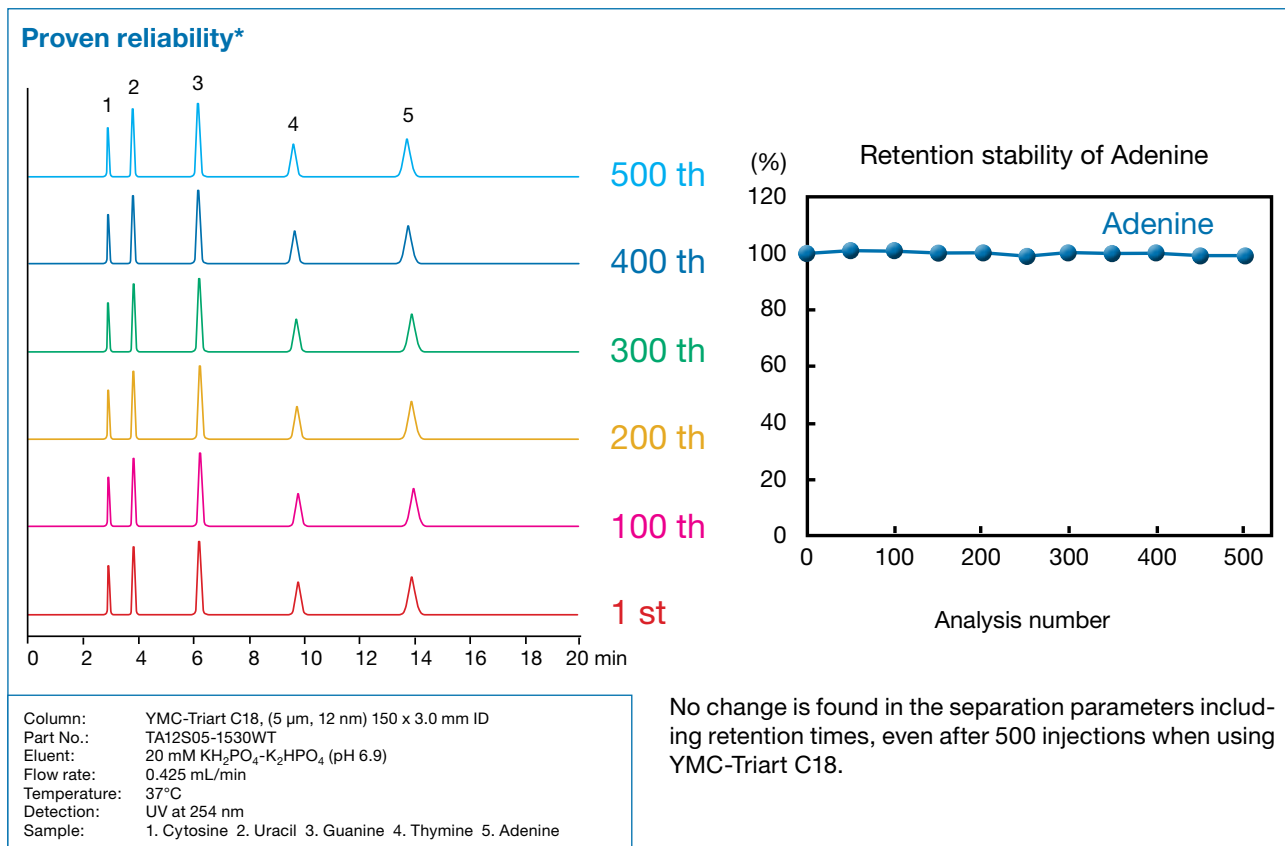

HILIC

Great stability and reproducibility at high pH*

Stability in high pH (pH 11, 50 °C)**

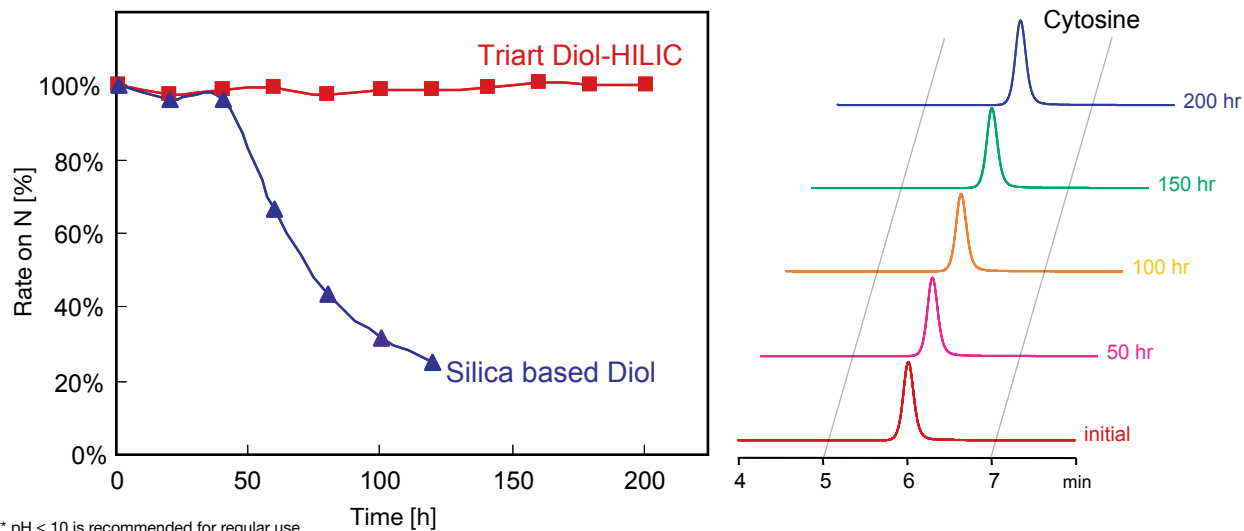

Column: 5 µm, 150 x 4.6 mm ID
Part No.: TDH12S05-1546WT
Eluent: acetonitrile / water / NH₃ (90/10/0.1) pH 11.3

Flow rate: 1.0 mL/min
Temperature: 50 °C
Sample: Cytosine

YMC-Triart Diol-HILIC offers highly reproducible separations even at high pH and high temperature. The lifetime of YMC-Triart Diol-HILIC is much longer than that of conventional silica-based Diol columns.

Nucleosides and bases*

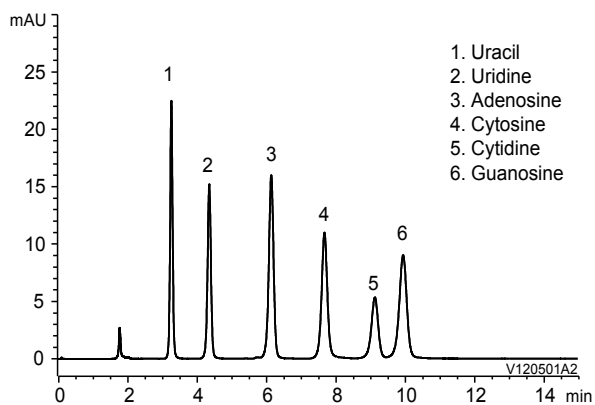

Column: YMC-Triart Diol-HILIC (5 µm, 12 nm) 150 x 3.0 mm ID
Part No.: TDH12S05-1503WT
Eluent: 100 mM CH₃COONH₄ / acetonitrile (10/90)
Flow rate: 0.425 mL/min
Temperature: 30 °C
Detection: UV at 254 nm
Injection: 2 µL (5 ~ 10 µg/mL)

Diabetes drugs*

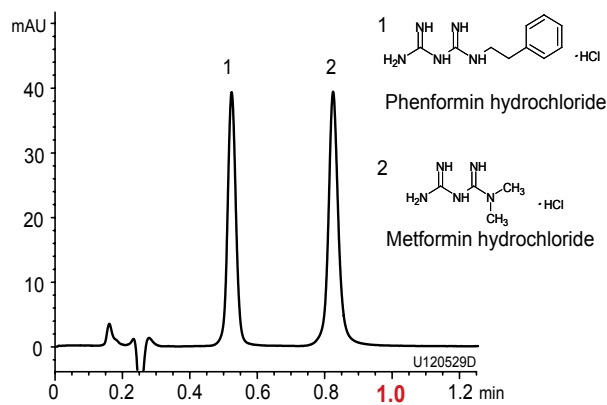

Column: YMC-Triart Diol-HILIC (1.9 µm, 12 nm) 50 x 2.0 mm ID
Part No.: TDH12SP9-0502PT
Eluent: 100 mM HCOOH-HCOONH₄ (pH 3.7) / acetonitrile (10/90)
Flow rate: 0.8 mL/min
Temperature: 25 °C
Detection: UV at 235 nm
Injection: 2 µL (10 µg/mL)

HILIC

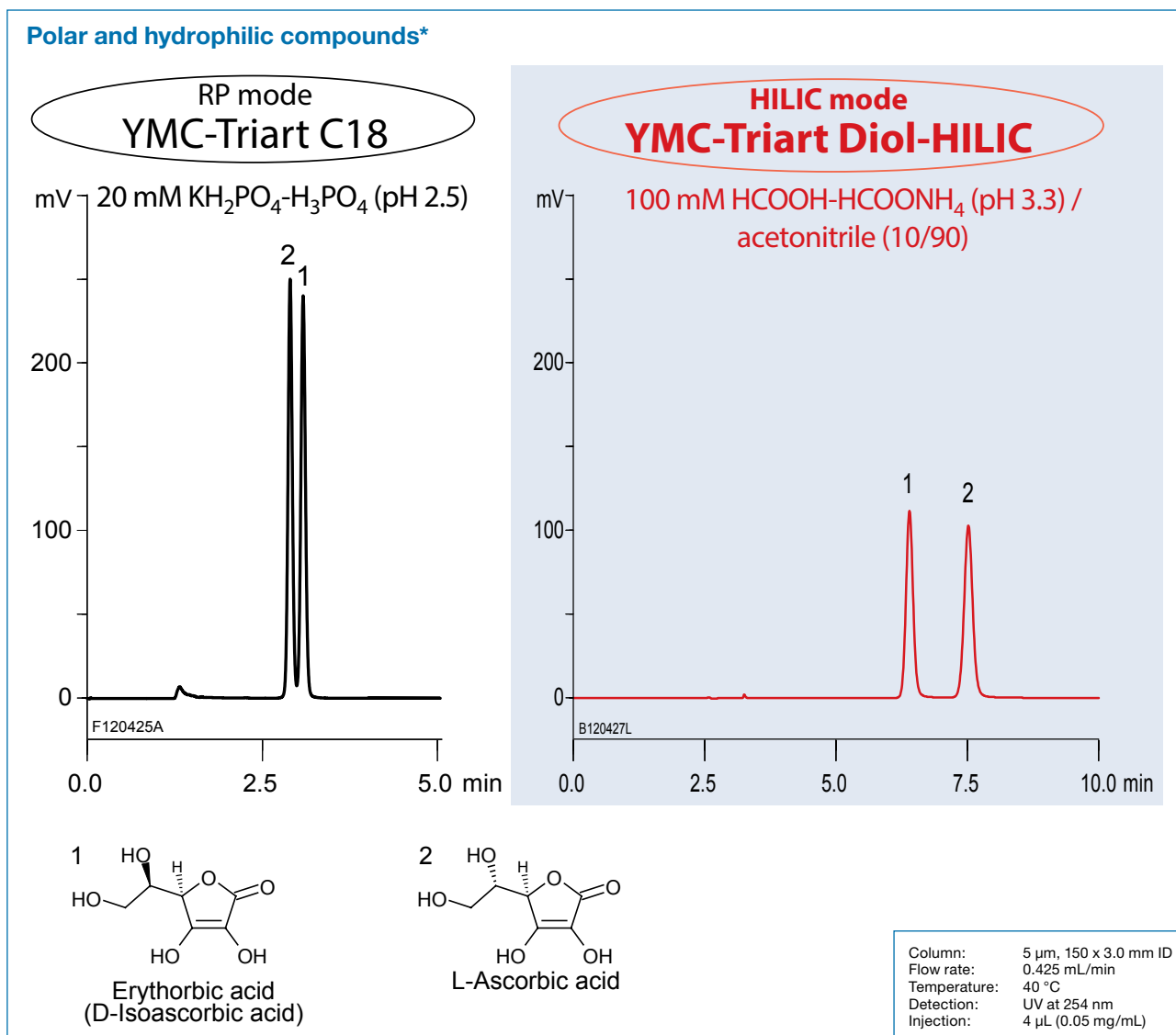

YMC-Triart C18 (RP) shows very weak retention and poor resolution of L-ascorbic acid and its stereoisomer (erythorbic acid) even if 100% aqueous mobile phase is used. However, YMC-Triart Diol-HILIC shows strong retention and good resolution of these compounds with mobile phase containing 90% organic solvent.

QC Data

YMC-Triart: Improved quality of particles

Uniform spherical particles

YMC-Triart



by courtesy of YMC Co., Ltd.

X-Bridge HILIC

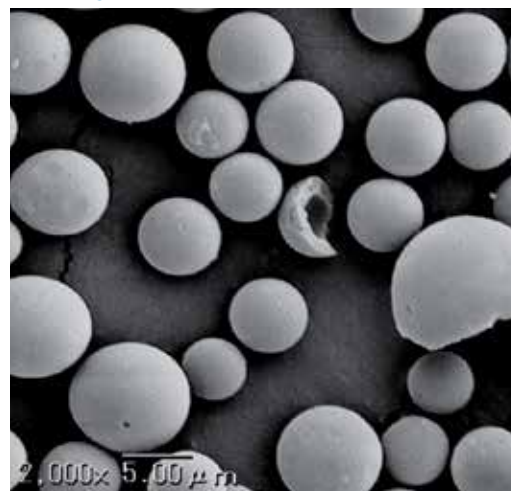

The uniform spherical particle support is used for all YMC-Triart phases. The particles are produced using **micro-reactor** technology for the granulation process. This results in reduction of the back-pressure and leads to more reproducibility in surface modification.

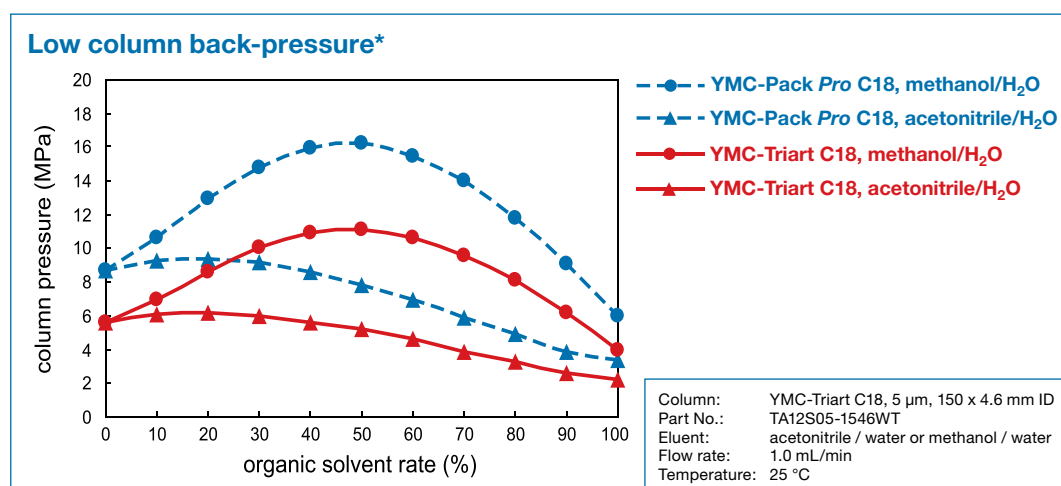

The revolutionary production technique, adapted from micro-reactor flow technology, produces a silica/organic hybrid stationary phase, with outstanding narrow pore size and particle size distributions which result in low back pressures.

YMC-Triart is designed for use under a wide range of conditions. Elution with higher viscosity methanol (compared with acetonitrile), YMC-Triart generates lower pressure (approx 30% lower than with conventional phases).

QC Data

Excellent reproducibility of YMC-Triart phases is available on consecutive lots even for the analysis for basic and coordination compounds which normally exhibit tailing and adsorption effects.

Batch-to-batch reproducibility

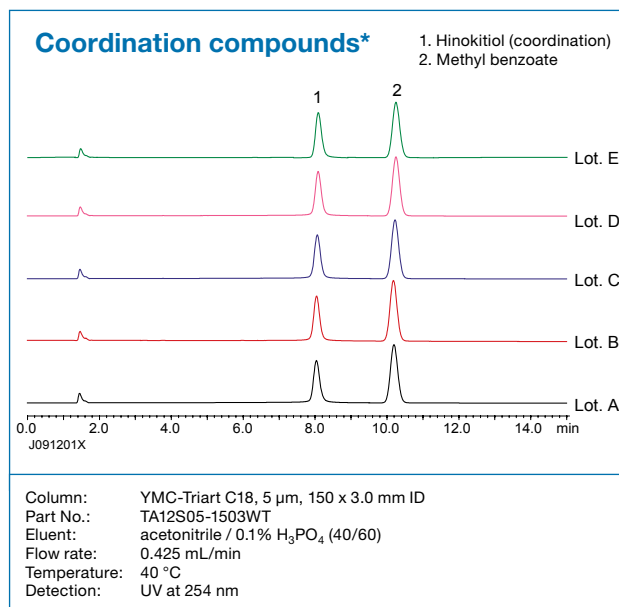
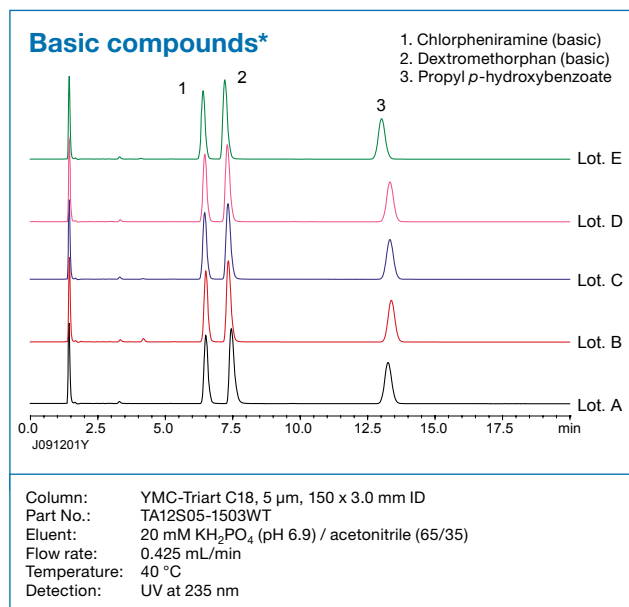

The reproducibility of packed columns is shown below in terms of theoretical plate number (N) and tailing factor (Tf). YMC-Triart packed columns exhibit a very narrow range of variation.

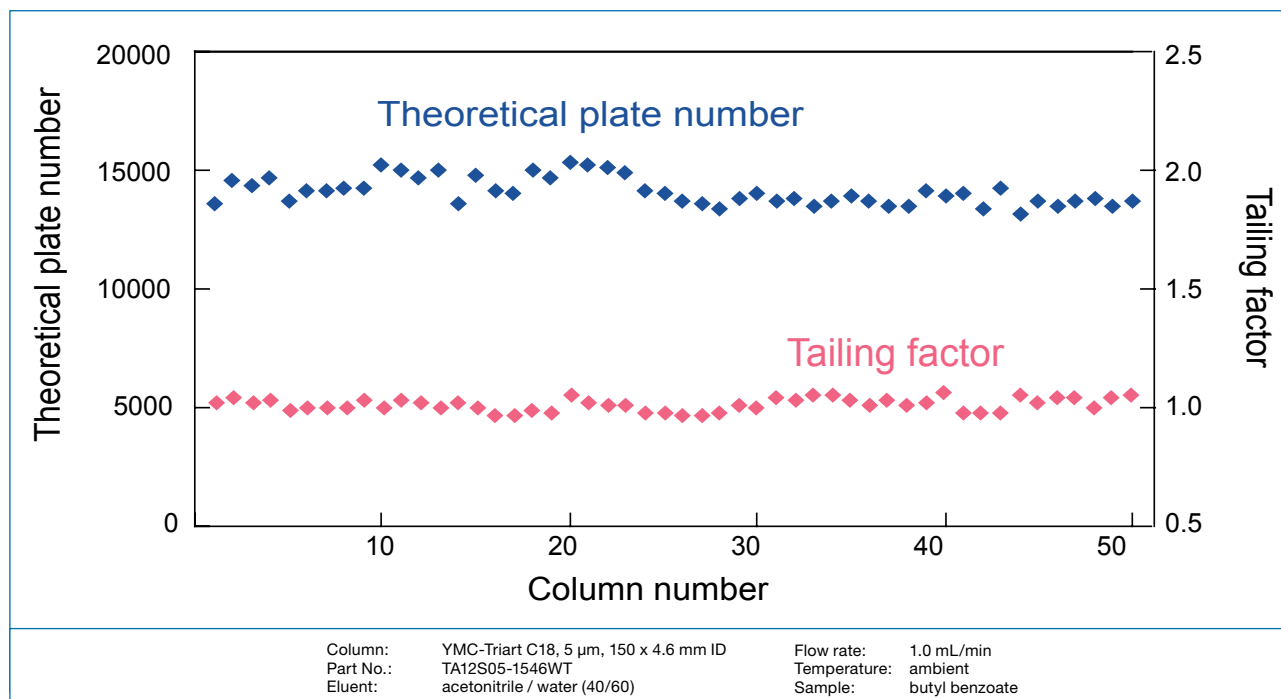

QC Data

Narrow pore distribution

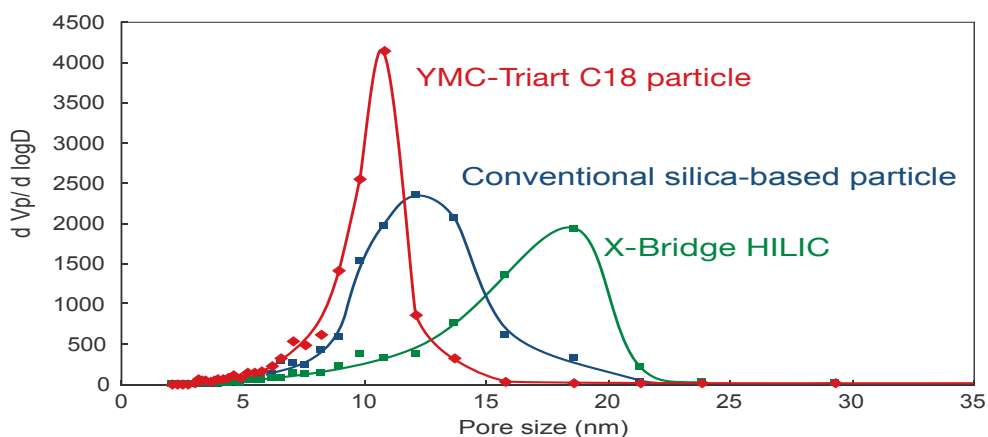

This figure shows the pore size distributions of some competitive stationary phases. Comparing the pore size distributions shows a narrower distribution for YMC-Triart which results in sharper peak shapes.

Improved loadability

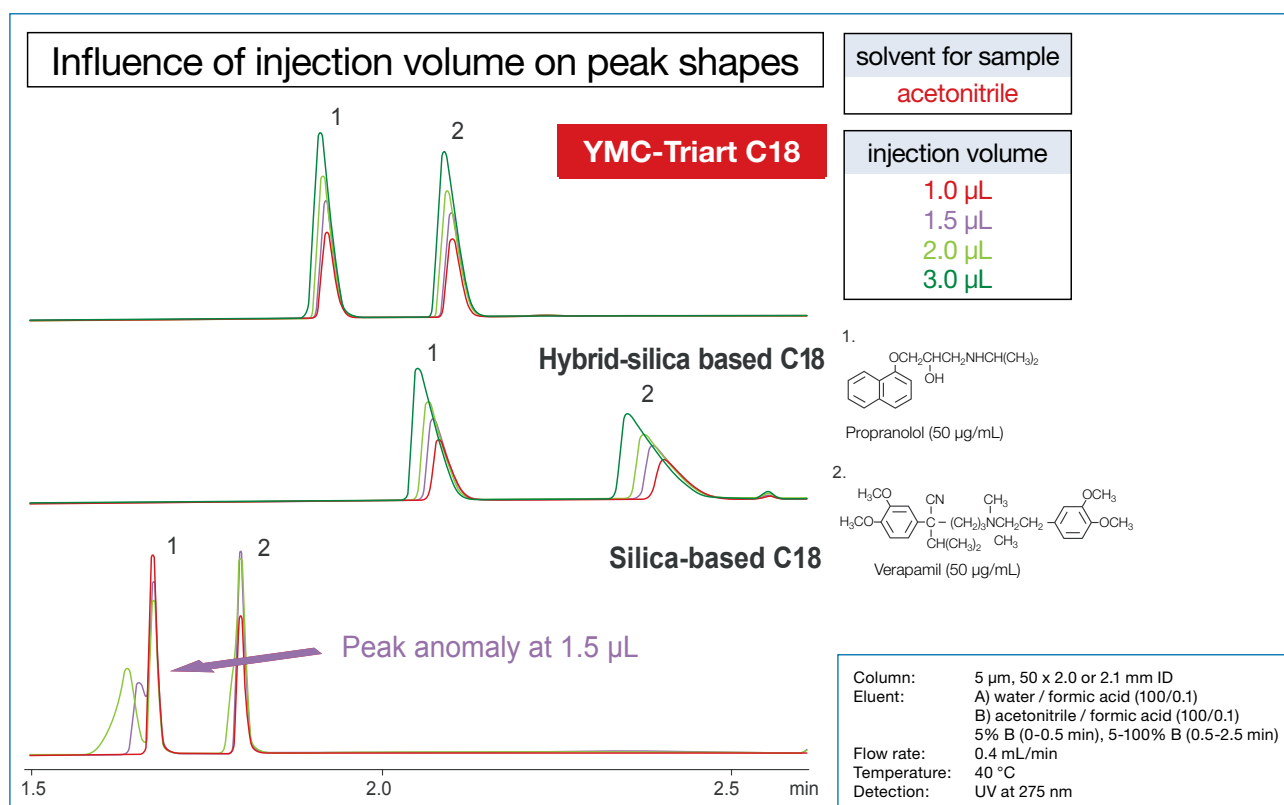

In order to prevent peak errors, there is a limit to the injection volume when a sample is injected in high elution solvents (such as 100% acetonitrile). Compared with traditional columns, more than double the injection volume can be injected into YMC-Triart columns as a result of the extremely narrow particle size distribution.

QC Data

Multi-stage endcapping

After bonding the alkyl chain, there are highly reactive and less reactive silanols on the surface. In traditional bonding processes, these are reacted with a single endcapping-compound in one step. However, the highly reactive silanols can be hydrolysed easily which contributes to the poor stability. The less reactive silanols are hard to endcap which results in poor resolution due to peak tailing.

YMC-Triart phases use an innovation in endcapping called "multistage endcapping" for its surface modification process. By using a number of compounds with different reactivities in successive steps, all silanols can be capped to the maximum extent.

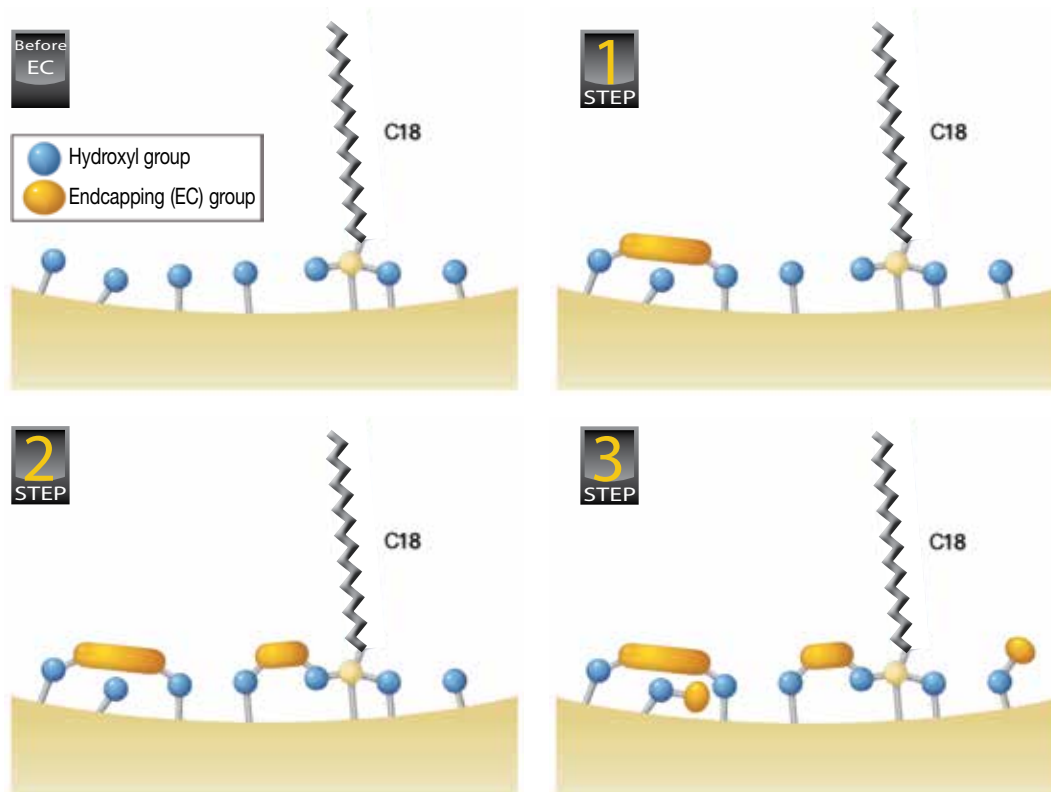

The chromatographic result of a "good" endcapping is demonstrated:

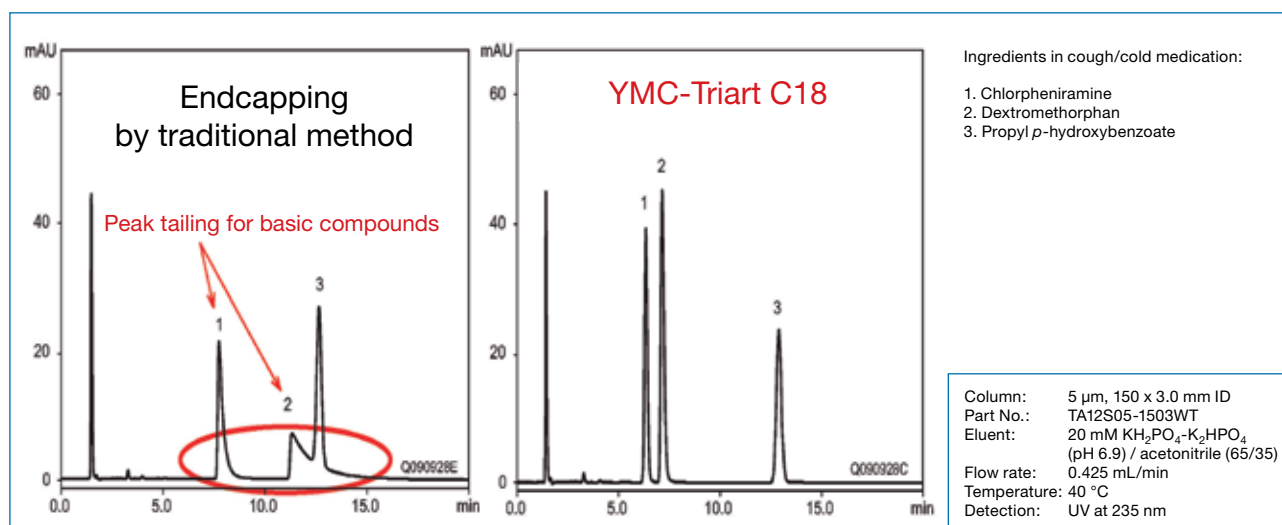

QC Data

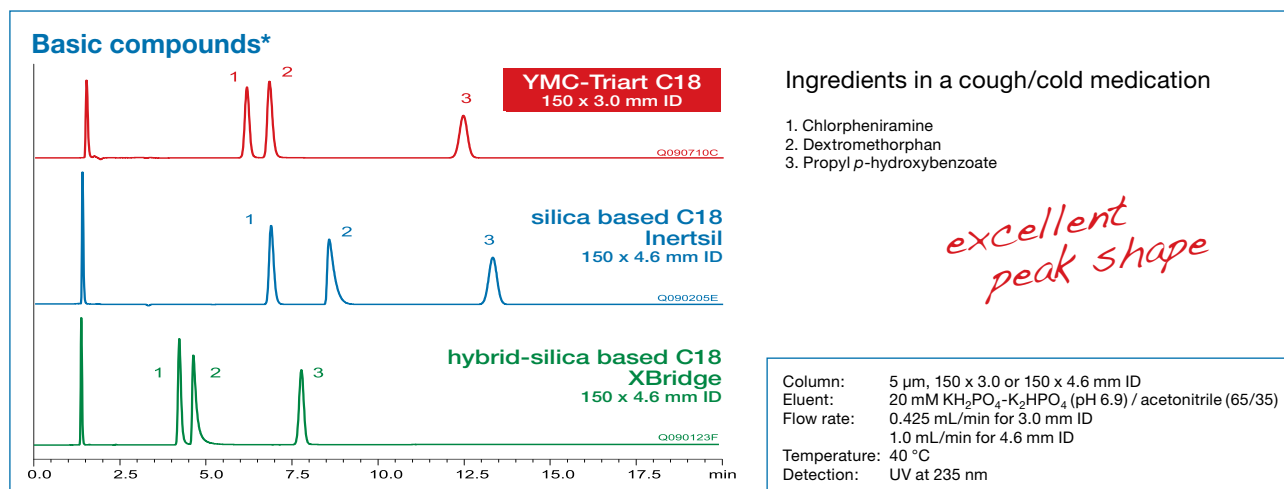

The innovative surface modification technology results in excellent peak shapes even for basic compounds that often exhibit peak tailing with conventional silica- and hybrid silica-based reversed phase columns.

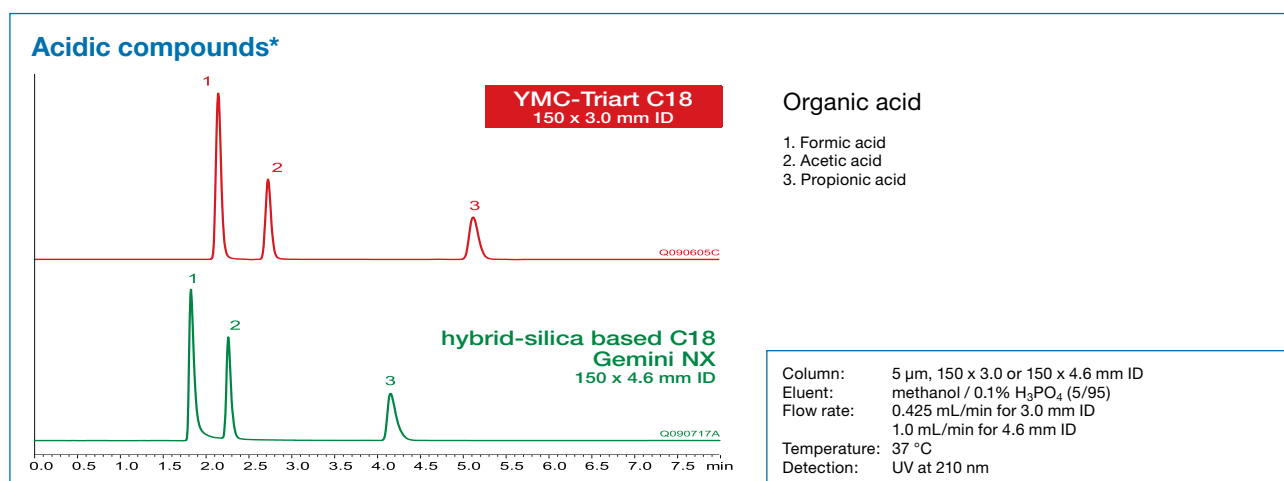

YMC-Triart phases are synthesised using methodology adapted from micro-reactor technology. This technique ensures a reduction of impurities that contribute to peak tailing during the analysis of some types acidic compounds.

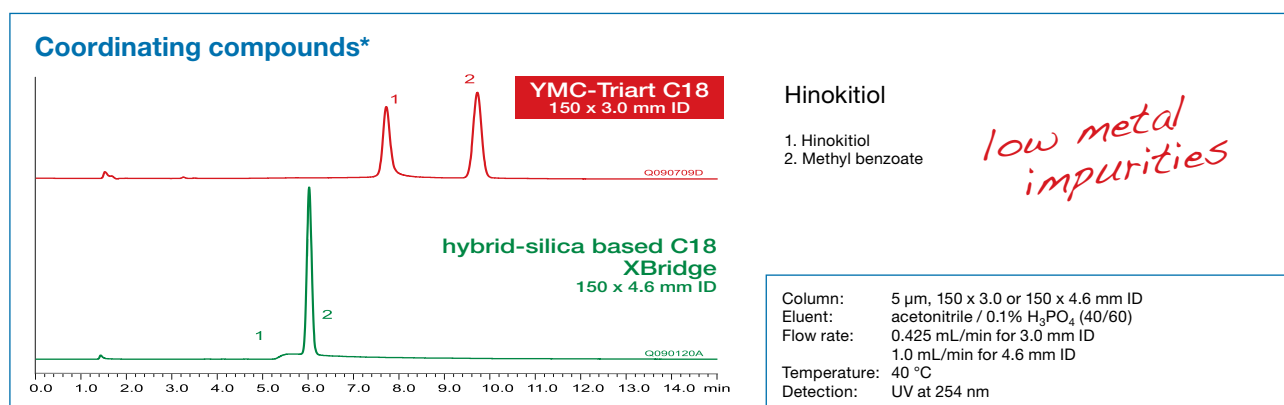

YMC-Triart phases have an extremely low level of metal impurities, much lower than conventional products, ensuring excellent peak shape for coordination compounds.

QC Data

Comparison of clemastine analysis*

10 mM phosphate buffer (pH 6.7)/organic solvent

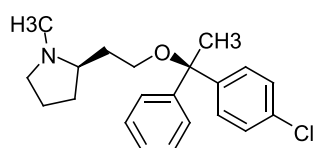
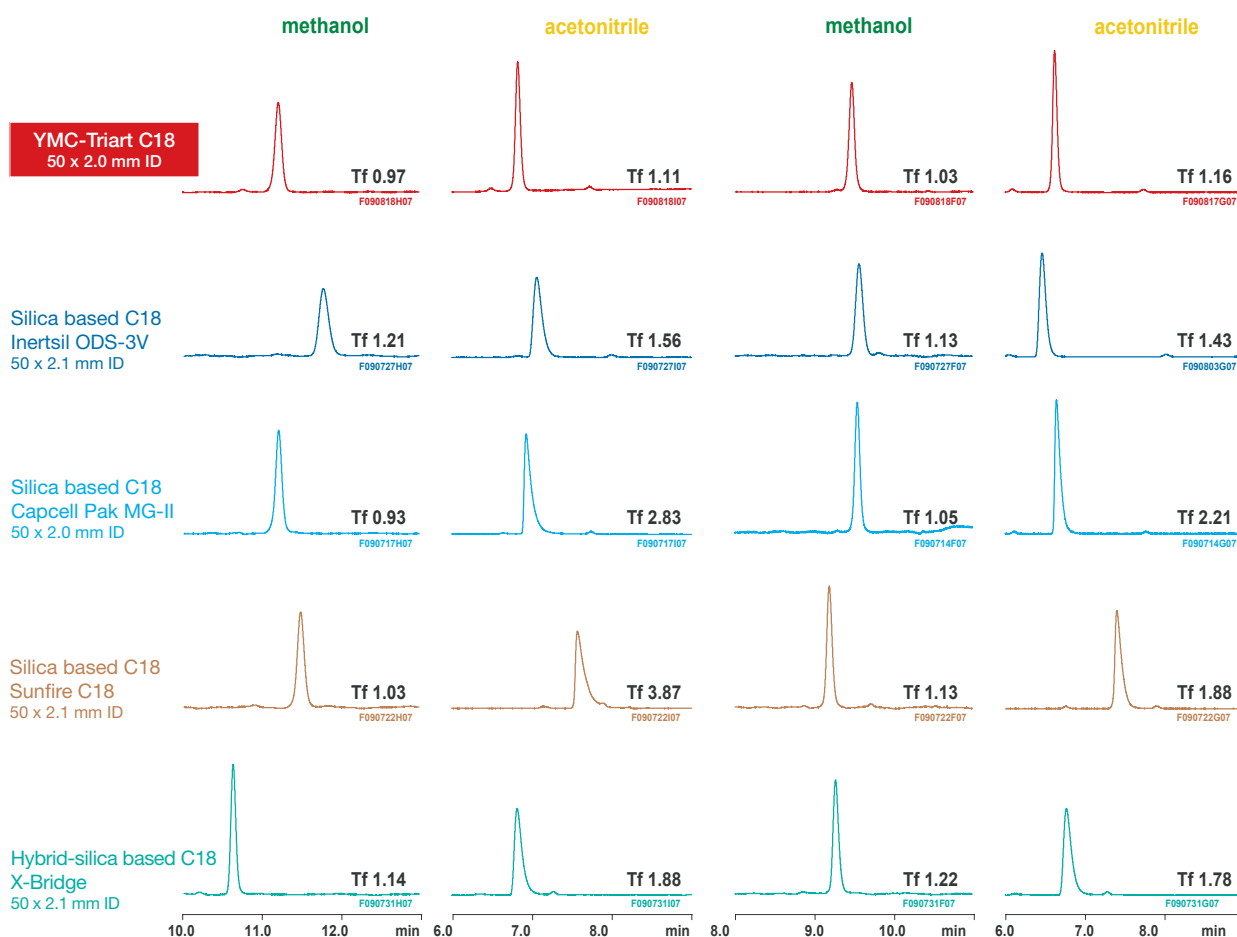
10 mM CH₃COONH₄/organic solvent

Clemastine

Column: 5 μ m, 50 x 2.0 or 50 x 2.1 mm ID
 Eluent: A) 10 mM KH₂PO₄-K₂HPO₄ (pH 6.7) or 10 mM CH₃COONH₄
 B) methanol or acetonitrile
 5-90% B (0-10 min), 90% B (10-15 min)
 Flow rate: 0.2 mL/min
 Temperature: 25 °C
 Detection: UV at 230 nm

Clemastine is a well-known basic compound which readily exhibits peak tailing with conventional ODS columns. YMC-Triart C18 provides sharp separations with many different buffer/solvent compositions.

Ordering Information

YMC-Triart 1.9 μ m UHPLC columns (max. pressure 1,000 bar)

Phase	Column ID (mm)	Column length (mm)						Guard cartridges* with 5 mm length (pack of 3)
		20	30/33	50	75	100	150	
C18	2.0	TA12SP9-0202PT	TA12SP9-0302PT	TA12SP9-0502PT	TA12SP9-L502PT	TA12SP9-1002PT	TA12SP9-1502PT	TA12SP9-E5Q1CC**
	3.0	—	—	TA12SP9-0503PT	TA12SP9-L503PT	TA12SP9-1003PT	TA12SP9-1503PT	TA12SP9-E503CC
C18 ExRS	2.0	TAR08SP9-0202PT	TAR08SP9-H302PT	TAR08SP9-0502PT	TAR08SP9-L502PT	TAR08SP9-1002PT	TAR08SP9-1502PT	TAR08SP9-E5Q1CC**
	3.0	—	—	TAR08SP9-0503PT	TAR08SP9-L503PT	TAR08SP9-1003PT	TAR08SP9-1503PT	TAR08SP9-E503CC
C8	2.0	T012SP9-0202PT	T012SP9-0302PT	T012SP9-0502PT	T012SP9-L502PT	T012SP9-1002PT	T012SP9-1502PT	T012SP9-E5Q1CC**
	3.0	—	—	T012SP9-0503PT	T012SP9-L503PT	T012SP9-1003PT	T012SP9-1503PT	T012SP9-E503CC
Phenyl	2.0	TPH12SP9-0202PT	TPH12SP9-0302PT	TPH12SP9-0502PT	TPH12SP9-L502PT	TPH12SP9-1002PT	TPH12SP9-1502PT	TPH12SP9-E5Q1CC**
	3.0	—	—	TPH12SP9-0503PT	TPH12SP9-L503PT	TPH12SP9-1003PT	TPH12SP9-1503PT	TPH12SP9-E503CC
PPF	2.0	TPF12SP9-0202PT	TPF12SP9-0302PT	TPF12SP9-0502PT	TPF12SP9-L502PT	TPF12SP9-1002PT	TPF12SP9-1502PT	TPF12SP9-E5Q1CC**
	3.0	—	—	TPF12SP9-0503PT	TPF12SP9-L503PT	TPF12SP9-1003PT	TPF12SP9-1503PT	TPF12SP9-E503CC
HILIC	2.0	—	—	TDH12SP9-0502PT	TDH12SP9-L502PT	TDH12SP9-1002PT	—	TDH12SP9-E5Q1CC**
	3.0	—	—	TDH12SP9-0503PT	TDH12SP9-L503PT	TDH12SP9-1003PT	—	—

*Guard cartridge holder required, part no. XPCUHHP

**Guard cartridge: 2.1 mm ID

For other dimensions please refer to page 352-353



Ordering Information



YMC-Triart 3 µm high pressure rated analytical columns (max. pressure 450 bar)

Phase	Column ID (mm)	Column length (mm)							Guard cartridges* with 10 mm length (pack of 5)
		20	33	50	75	100	150	250	
C18	2.1	TA12S03-02Q1PTH	TA12S03-H3Q1PTH	TA12S03-05Q1PTH	TA12S03-L5Q1PTH	TA12S03-10Q1PTH	TA12S03-15Q1PTH	—	TA12S03-01Q1GC
	3.0	—	—	TA12S03-05Q3PTH	TA12S03-L5Q3PTH	TA12S03-10Q3PTH	TA12S03-15Q3PTH	—	TA12S03-01Q3GC
	4.6	—	TA12S03-H346PTH	TA12S03-0546PTH	TA12S03-L546PTH	TA12S03-1046PTH	TA12S03-1546PTH	TA12S03-2546PTH	TA12S03-01Q4GC
C18 ExRS	2.1	TAR08S03-02Q1PTH	TAR08S03-H3Q1PTH	TAR08S03-05Q1PTH	TAR08S03-L5Q1PTH	TAR08S03-10Q1PTH	TAR08S03-15Q1PTH	—	TAR08S03-01Q1GC
	3.0	—	—	TAR08S03-05Q3PTH	TAR08S03-L5Q3PTH	TAR08S03-10Q3PTH	TAR08S03-15Q3PTH	—	TAR08S03-01Q3GC
	4.6	—	TAR08S03-H346PTH	TAR08S03-0546PTH	TAR08S03-L546PTH	TAR08S03-1046PTH	TAR08S03-1546PTH	TAR08S03-2546PTH	TAR08S03-01Q4GC
C8	2.1	TO12S03-02Q1PTH	TO12S03-H3Q1PTH	TO12S03-05Q1PTH	TO12S03-L5Q1PTH	TO12S03-10Q1PTH	TO12S03-15Q1PTH	—	TO12S03-01Q1GC
	3.0	—	—	TO12S03-05Q3PTH	TO12S03-L5Q3PTH	TO12S03-10Q3PTH	TO12S03-15Q3PTH	—	TO12S03-01Q3GC
	4.6	—	TO12S03-H346PTH	TO12S03-0546PTH	TO12S03-L546PTH	TO12S03-1046PTH	TO12S03-1546PTH	TO12S03-2546PTH	TO12S03-01Q4GC
Phenyl	2.1	TPH12S03-02Q1PTH	TPH12S03-H3Q1PTH	TPH12S03-05Q1PTH	TPH12S03-L5Q1PTH	TPH12S03-10Q1PTH	TPH12S03-15Q1PTH	—	TPH12S03-01Q1GC
	3.0	—	—	TPH12S03-05Q3PTH	TPH12S03-L5Q3PTH	TPH12S03-10Q3PTH	TPH12S03-15Q3PTH	—	TPH12S03-01Q3GC
	4.6	—	TPH12S03-H346PTH	TPH12S03-0546PTH	TPH12S03-L546PTH	TPH12S03-1046PTH	TPH12S03-1546PTH	TPH12S03-2546PTH	TPH12S03-01Q4GC
PPF	2.1	TPF12S03-02Q1PTH	TPF12S03-H3Q1PTH	TPF12S03-05Q1PTH	TPF12S03-L5Q1PTH	TPF12S03-10Q1PTH	TPF12S03-15Q1PTH	—	TPF12S03-01Q1GC
	3.0	—	—	TPF12S03-05Q3PTH	TPF12S03-L5Q3PTH	TPF12S03-10Q3PTH	TPF12S03-15Q3PTH	—	TPF12S03-01Q3GC
	4.6	—	TPF12S03-H346PTH	TPF12S03-0546PTH	TPF12S03-L546PTH	TPF12S03-1046PTH	TPF12S03-1546PTH	TPF12S03-2546PTH	TPF12S03-01Q4GC
HILIC	2.1	TDH12S03-02Q1PTH	TDH12S03-H3Q1PTH	TDH12S03-05Q1PTH	TDH12S03-L5Q1PTH	TDH12S03-10Q1PTH	TDH12S03-15Q1PTH	—	TDH12S03-01Q1GC
	3.0	—	—	TDH12S03-05Q3PTH	TDH12S03-L5Q3PTH	TDH12S03-10Q3PTH	TDH12S03-15Q3PTH	—	TDH12S03-01Q3GC
	4.6	—	TDH12S03-H346PTH	TDH12S03-0546PTH	TDH12S03-L546PTH	TDH12S03-1046PTH	TDH12S03-1546PTH	TDH12S03-2546PTH	TDH12S03-01Q4GC

*Guard cartridge holder required, part no. XPGCH-Q1



YMC-Triart 5 µm high pressure rated analytical columns (max. pressure 450 bar)

Phase	Column ID (mm)	Column length (mm)							Guard cartridges* with 10 mm length (pack of 5)
		20	33	50	75	100	150	250	
C18	2.1	TA12S05-02Q1PTH	TA12S05-H3Q1PTH	TA12S05-05Q1PTH	TA12S05-L5Q1PTH	TA12S05-10Q1PTH	TA12S05-15Q1PTH	—	TA12S05-01Q1GC
	3.0	—	—	TA12S05-05Q3PTH	TA12S05-L5Q3PTH	TA12S05-10Q3PTH	TA12S05-15Q3PTH	—	TA12S05-01Q3GC
	4.6	—	TA12S05-H346PTH	TA12S05-0546PTH	TA12S05-L546PTH	TA12S05-1046PTH	TA12S05-1546PTH	TA12S05-2546PTH	TA12S05-01Q4GC
C18 ExRS	2.1	TAR08S05-02Q1PTH	TAR08S05-H3Q1PTH	TAR08S05-05Q1PTH	TAR08S05-L5Q1PTH	TAR08S05-10Q1PTH	TAR08S05-15Q1PTH	—	TAR08S05-01Q1GC
	3.0	—	—	TAR08S05-05Q3PTH	TAR08S05-L5Q3PTH	TAR08S05-10Q3PTH	TAR08S05-15Q3PTH	—	TAR08S05-01Q3GC
	4.6	—	TAR08S05-H346PTH	TAR08S05-0546PTH	TAR08S05-L546PTH	TAR08S05-1046PTH	TAR08S05-1546PTH	TAR08S05-2546PTH	TAR08S05-01Q4GC
C8	2.1	TO12S05-02Q1PTH	TO12S05-H3Q1PTH	TO12S05-05Q1PTH	TO12S05-L5Q1PTH	TO12S05-10Q1PTH	TO12S05-15Q1PTH	—	TO12S05-01Q1GC
	3.0	—	—	TO12S05-05Q3PTH	TO12S05-L5Q3PTH	TO12S05-10Q3PTH	TO12S05-15Q3PTH	—	TO12S05-01Q3GC
	4.6	—	TO12S05-H346PTH	TO12S05-0546PTH	TO12S05-L546PTH	TO12S05-1046PTH	TO12S05-1546PTH	TO12S05-2546PTH	TO12S05-01Q4GC
Phenyl	2.1	TPH12S05-02Q1PTH	TPH12S05-H3Q1PTH	TPH12S05-05Q1PTH	TPH12S05-L5Q1PTH	TPH12S05-10Q1PTH	TPH12S05-15Q1PTH	—	TPH12S05-01Q1GC
	3.0	—	—	TPH12S05-05Q3PTH	TPH12S05-L5Q3PTH	TPH12S05-10Q3PTH	TPH12S05-15Q3PTH	—	TPH12S05-01Q3GC
	4.6	—	TPH12S05-H346PTH	TPH12S05-0546PTH	TPH12S05-L546PTH	TPH12S05-1046PTH	TPH12S05-1546PTH	TPH12S05-2546PTH	TPH12S05-01Q4GC
PPF	2.1	TPF12S05-02Q1PTH	TPF12S05-H3Q1PTH	TPF12S05-05Q1PTH	TPF12S05-L5Q1PTH	TPF12S05-10Q1PTH	TPF12S05-15Q1PTH	—	TPF12S05-01Q1GC
	3.0	—	—	TPF12S05-05Q3PTH	TPF12S05-L5Q3PTH	TPF12S05-10Q3PTH	TPF12S05-15Q3PTH	—	TPF12S05-01Q3GC
	4.6	—	TPF12S05-H346PTH	TPF12S05-0546PTH	TPF12S05-L546PTH	TPF12S05-1046PTH	TPF12S05-1546PTH	TPF12S05-2546PTH	TPF12S05-01Q4GC
HILIC	2.1	TDH12S05-02Q1PTH	TDH12S05-H3Q1PTH	TDH12S05-05Q1PTH	TDH12S05-L5Q1PTH	TDH12S05-10Q1PTH	TDH12S05-15Q1PTH	—	TDH12S05-01Q1GC
	3.0	—	—	TDH12S05-05Q3PTH	TDH12S05-L5Q3PTH	TDH12S05-10Q3PTH	TDH12S05-15Q3PTH	—	TDH12S05-01Q3GC
	4.6	—	TDH12S05-H346PTH	TDH12S05-0546PTH	TDH12S05-L546PTH	TDH12S05-1046PTH	TDH12S05-1546PTH	TDH12S05-2546PTH	TDH12S05-01Q4GC

*Guard cartridge holder required, part no. XPGCH-Q1

Novel column hardware technology with increased pressure rating; specifications for the individual bonding chemistries remain identical irrespective of the column hardware format selected.

Ordering Information

YMC-Triart 3 µm analytical columns (max. pressure 200/250 bar)

Phase	Column ID (mm)	Column length (mm)							Guard cartridges* with 10 mm length (pack of 5)
		20	30	50	75	100	150	250	
C18	2.0	TA12S03-0202WT	TA12S03-0302WT	TA12S03-0502WT	TA12S03-L502WT	TA12S03-1002WT	TA12S03-1502WT	—	TA12S03-01Q1GC
	3.0	—	—	TA12S03-0503WT	TA12S03-L503WT	TA12S03-1003WT	TA12S03-1503WT	—	TA12S03-0103GC
	4.6	—	—	TA12S03-0546WT	TA12S03-L546WT	TA12S03-1046WT	TA12S03-1546WT	TA12S03-2546WT	TA12S03-0104GC
C8	2.0	TO12S03-0202WT	TO12S03-0302WT	TO12S03-0502WT	TO12S03-L502WT	TO12S03-1002WT	TO12S03-1502WT	—	TO12S03-01Q1GC
	3.0	—	—	TO12S03-0503WT	TO12S03-L503WT	TO12S03-1003WT	TO12S03-1503WT	—	TO12S03-0103GC
	4.6	—	—	TO12S03-0546WT	TO12S03-L546WT	TO12S03-1046WT	TO12S03-1546WT	TO12S03-2546WT	TO12S03-0104GC
Phenyl	2.0	TPH12S03-0202WT	TPH12S03-0302WT	TPH12S03-0502WT	TPH12S03-L502WT	TPH12S03-1002WT	TPH12S03-1502WT	—	TPH12S03-01Q1GC
	3.0	—	—	TPH12S03-0503WT	TPH12S03-L503WT	TPH12S03-1003WT	TPH12S03-1503WT	—	TPH12S03-0103GC
	4.6	—	—	TPH12S03-0546WT	TPH12S03-L546WT	TPH12S03-1046WT	TPH12S03-1546WT	TPH12S03-2546WT	TPH12S03-0104GC
PFP	2.0	TPF12S03-0202WT	TPF12S03-0302WT	TPF12S03-0502WT	TPF12S03-L502WT	TPF12S03-1002WT	TPF12S03-1502WT	—	TPF12S03-01Q1GC
	3.0	—	—	TPF12S03-0503WT	TPF12S03-L503WT	TPF12S03-1003WT	TPF12S03-1503WT	—	TPF12S03-0103GC
	4.6	—	—	TPF12S03-0546WT	TPF12S03-L546WT	TPF12S03-1046WT	TPF12S03-1546WT	TPF12S03-2546WT	TPF12S03-0104GC
HILIC	2.0	TDH12S03-0202WT	TDH12S03-0302WT	TDH12S03-0502WT	TDH12S03-L502WT	TDH12S03-1002WT	TDH12S03-1502WT	—	TDH12S03-01Q1GC
	3.0	—	—	TDH12S03-0503WT	TDH12S03-L503WT	TDH12S03-1003WT	TDH12S03-1503WT	—	TDH12S03-0103GC
	4.6	—	—	TDH12S03-0546WT	TDH12S03-L546WT	TDH12S03-1046WT	TDH12S03-1546WT	TDH12S03-2546WT	TDH12S03-0104GC

*Guard cartridge holder required, part no. XPGCH-Q1

YMC-Triart 5 µm analytical columns (max. pressure 200/250 bar)

Phase	Column ID (mm)	Column length (mm)							Guard cartridges* with 10 mm length (pack of 5)
		20	30	50	75	100	150	250	
C18	2.0	TA12S05-0202WT	TA12S05-0302WT	TA12S05-0502WT	TA12S05-L502WT	TA12S05-1002WT	TA12S05-1502WT	—	TA12S05-01Q1GC
	3.0	—	—	TA12S05-0503WT	TA12S05-L503WT	TA12S05-1003WT	TA12S05-1503WT	—	TA12S05-0103GC
	4.6	—	—	TA12S05-0546WT	TA12S05-L546WT	TA12S05-1046WT	TA12S05-1546WT	TA12S05-2546WT	TA12S05-0104GC
	10**	—	—	—	—	—	TA12S05-1510WT	TA12S05-2510WT	TA12S05-0110CC
C8	2.0	TO12S05-0202WT	TO12S05-0302WT	TO12S05-0502WT	TO12S05-L502WT	TO12S05-1002WT	TO12S05-1502WT	—	TO12S05-01Q1GC
	3.0	—	—	TO12S05-0503WT	TO12S05-L503WT	TO12S05-1003WT	TO12S05-1503WT	—	TO12S05-0103GC
	4.6	—	—	TO12S05-0546WT	TO12S05-L546WT	TO12S05-1046WT	TO12S05-1546WT	TO12S05-2546WT	TO12S05-0104GC
	10**	—	—	—	—	—	TO12S05-1510WT	TO12S05-2510WT	TO12S05-0110CC
Phenyl	2.0	TPH12S05-0202WT	TPH12S05-0302WT	TPH12S05-0502WT	TPH12S05-L502WT	TPH12S05-1002WT	TPH12S05-1502WT	—	TPH12S05-01Q1GC
	3.0	—	—	TPH12S05-0503WT	TPH12S05-L503WT	TPH12S05-1003WT	TPH12S05-1503WT	—	TPH12S05-0103GC
	4.6	—	—	TPH12S05-0546WT	TPH12S05-L546WT	TPH12S05-1046WT	TPH12S05-1546WT	TPH12S05-2546WT	TPH12S05-0104GC
	10**	—	—	—	—	—	TPH12S05-1510WT	TPH12S05-2510WT	TPH12S05-0110CC
PFP	2.0	TPF12S05-0202WT	TPF12S05-0302WT	TPF12S05-0502WT	TPF12S05-L502WT	TPF12S05-1002WT	TPF12S05-1502WT	—	TPF12S05-01Q1GC
	3.0	—	—	TPF12S05-0503WT	TPF12S05-L503WT	TPF12S05-1003WT	TPF12S05-1503WT	—	TPF12S05-0103GC
	4.6	—	—	TPF12S05-0546WT	TPF12S05-L546WT	TPF12S05-1046WT	TPF12S05-1546WT	TPF12S05-2546WT	TPF12S05-0104GC
	10**	—	—	—	—	—	TPF12S05-1510WT	TPF12S05-2510WT	TPF12S05-0110CC
HILIC	2.0	TDH12S05-0202WT	TDH12S05-0302WT	TDH12S05-0502WT	TDH12S05-L502WT	TDH12S05-1002WT	TDH12S05-1502WT	—	TDH12S05-01Q1GC
	3.0	—	—	TDH12S05-0503WT	TDH12S05-L503WT	TDH12S05-1003WT	TDH12S05-1503WT	—	TDH12S05-0103GC
	4.6	—	—	TDH12S05-0546WT	TDH12S05-L546WT	TDH12S05-1046WT	TDH12S05-1546WT	TDH12S05-2546WT	TDH12S05-0104GC

*Guard cartridge holder required, part no. XPGCH-Q1 (2.1, 3, 4 mm ID)

XPCHSPW1 (10 mm ID)

**Max. pressure 100 bar

Ordering Information

**YMC-Triart, 5 µm in ACTUS high-throughput semipreparative hardware
(max. pressure 300 bar)**

Phase	Column ID (mm)	Column length (mm)				
		50	75	100	150	250
C18	20.0	TA12S05-0520WX	—	TA12S05-1020WX	TA12S05-1520WX	TA12S05-2520WX
	30.0	TA12S05-0530WX	TA12S05-L530WX	TA12S05-1030WX	TA12S05-1530WX	TA12S05-2530WX
C18 ExRS	20.0	TAR08S05-0520WX	—	TAR08S05-1020WX	TAR08S05-1520WX	TAR08S05-2520WX
	30.0	TAR08S05-0530WX	TAR08S05-L530WX	TAR08S05-1030WX	TAR08S05-1530WX	TAR08S05-2530WX
C8	20.0	T012S05-0520WX	—	T012S05-1020WX	T012S05-1520WX	T012S05-2520WX
	30.0	T012S05-0530WX	T012S05-L530WX	T012S05-1030WX	T012S05-1530WX	T012S05-2530WX
Phenyl	20.0	TPH12S05-0520WX	—	TPH12S05-1020WX	TPH12S05-1520WX	TPH12S05-2520WX
	30.0	TPH12S05-0530WX	TPH12S05-L530WX	TPH12S05-1030WX	TPH12S05-1530WX	TPH12S05-2530WX
PFP	20.0	TPF12S05-0520WX	—	TPF12S05-1020WX	TPF12S05-1520WX	TPF12S05-2520WX
	30.0	TPF12S05-0530WX	TPF12S05-L530WX	TPF12S05-1030WX	TPF12S05-1530WX	TPF12S05-2530WX



YMC-Actus

Contents

Cost Efficiency.....	66
Axial Compression Technology.....	67
 Secured Hardware Stability.....	68-69
Effective Method Development on Purification	70-73
Applications.....	74-75
Preparative Column Selection Finder.....	76
Linear Scale-Up.....	77
Ordering Information.....	78-81

Introduction

Fast semi-preparative chromatography

Semi-preparative chromatography is the link between analytical HPLC and preparative LC. Even though the chromatographic systems used for semi-preparative LC are not as large as preparative LC systems, the objectives remain the same:

- Purification and isolation of maximum sample quantity
- Savings in time and costs.

With YMC-Actus, time is on your side!

YMC-Actus

Cost efficiency

Rapid pressure changes under high-speed gradient conditions may lead to column degradation and loss of column performance.

With YMC-Actus, a specific hardware and packing technology has been applied to these semi-preparative columns to provide a uniform packing density, which results in a longer lifetime than conventional semi-preparative columns.

In order to determine the quality of the packing, the column performance has been evaluated every 100 runs with a sequential high-throughput gradient.

YMC-Actus columns offer outstanding efficiency without compromising resolution. Furthermore, YMC-Actus columns provide reliable results, even after exposure to severe, rapid gradient conditions and multiple injections.

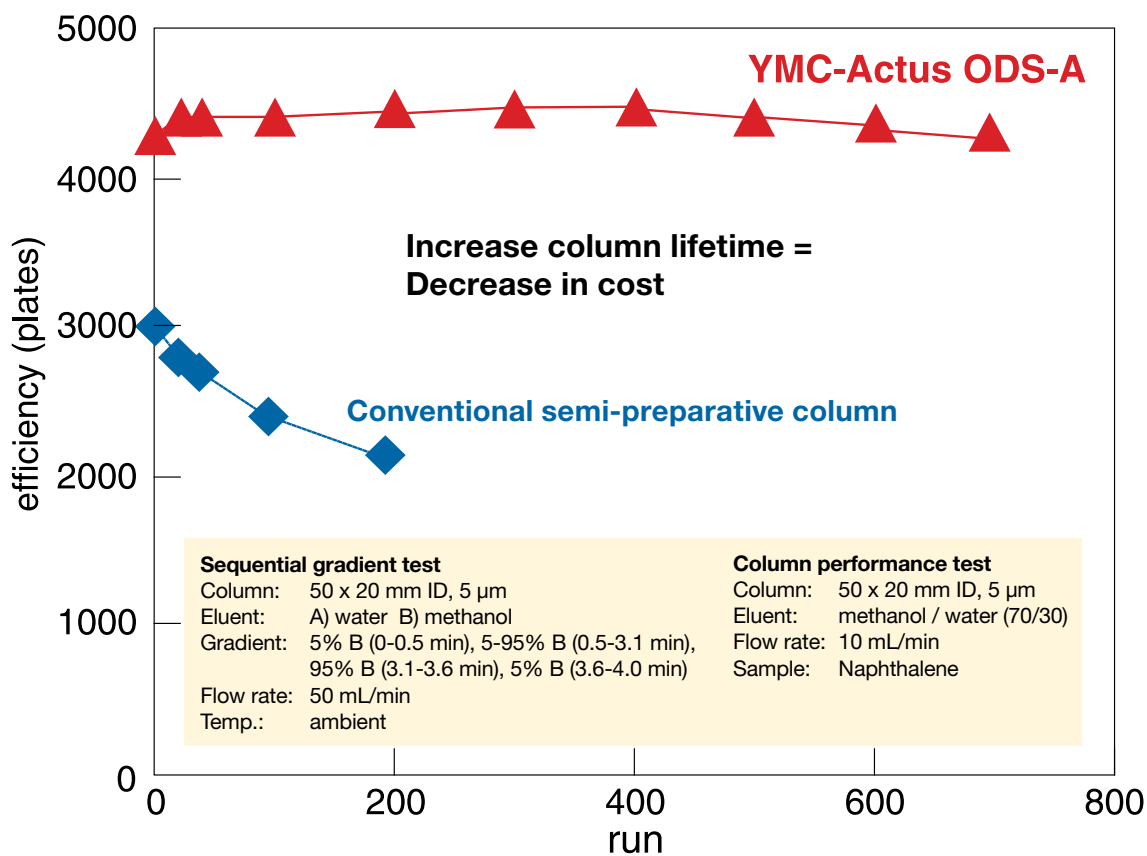

YMC-Actus

How to obtain long lasting columns?

YMC-Actus series columns are semi-preparative HPLC columns that have excellent column stability and efficiency as a result of applying axial compression technology. YMC-Actus series columns show high stability under high flow rate or steep gradient conditions which are desirable for milligram scale preparative HPLC of various compounds.

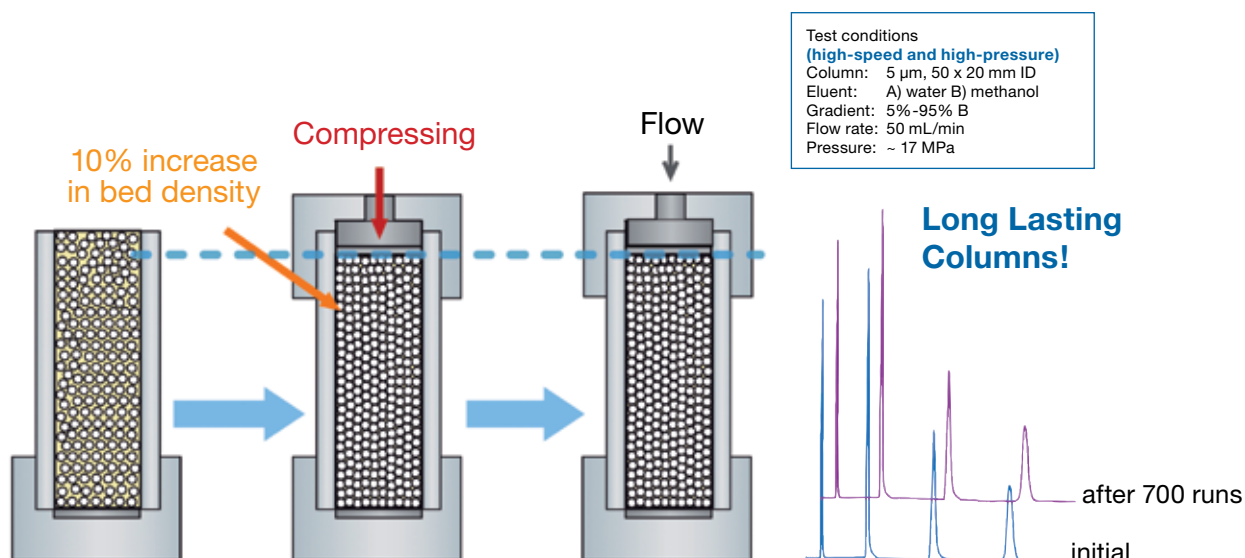

Conventional Column Packing

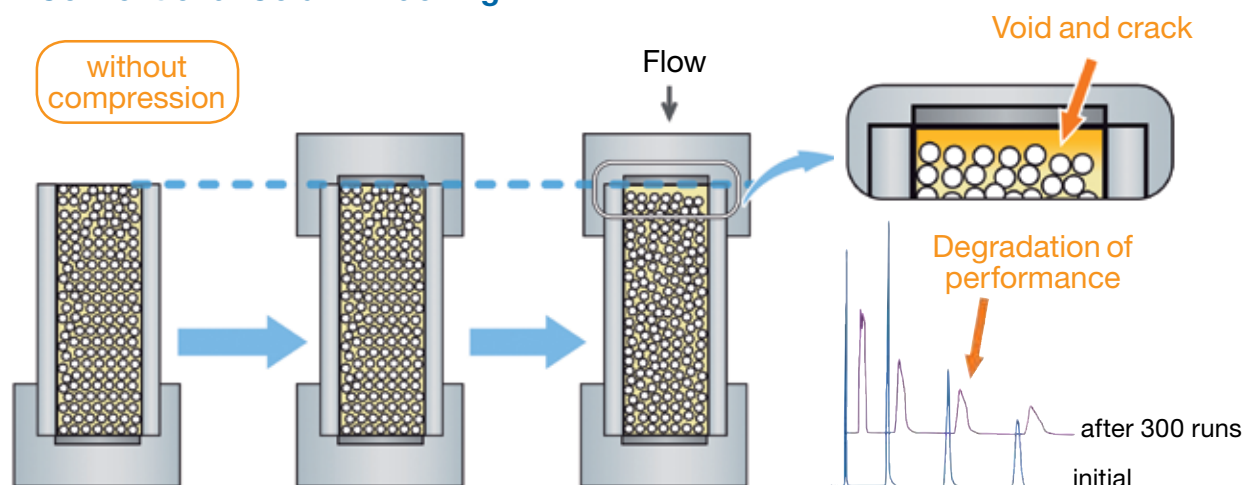

Uniformly high density packing is necessary for highly efficient and stable HPLC columns.

DAC (Dynamic Axial Compression) columns are widely used for preparative separation in pilot or production scale. This allows uniformly high density packing and prevents formation of voids.

YMC-Actus series columns have been developed by applying this Axial Compression Technology to semi-prep column production. The column bed is compressed appropriately when attaching the inlet end assembly of the newly designed YMC-Actus hardware. It provides increased bed density (10% higher than conventional columns) and bed uniformity.

YMC-Actus



Secured hardware stability

A study has been performed using the 50 mm ID YMC-Actus columns for 80 hours at a constant maximum column pressure. An initial column performance test and after 40 hours was carried out. No significant changes in performance were observed after hours of continuous pressurisation.

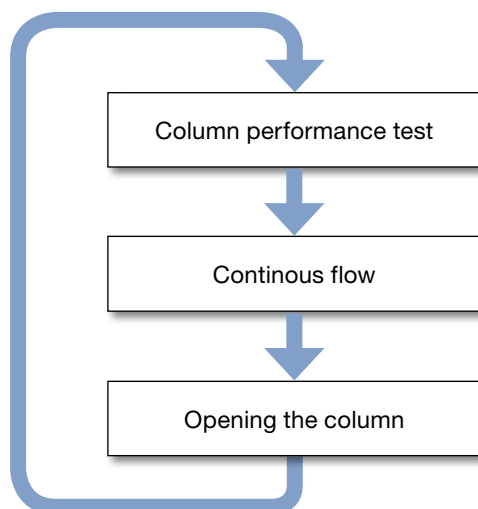

Column continuous flow

Column: YMC-Actus SIL (12 nm, 5 μ m)
250 x 50 mm ID
Part.-No.: SL12S05-2553DX
Eluent: *n*-hexane / ethanol (90/10)
Flow rate: 240 mL/min
Pressure: 200 bar
Temperature: ambient

Column performance test

Column: YMC-Actus SIL (12 nm, 5 μ m)
250 x 50 mm ID
Eluent: *n*-hexane / ethanol (90/10)
Flow rate: 50 mL/min
Temperature: ambient
Detection: UV at 254 nm
Sample: 1. Toluene (500 μ L/mL)
2. Nitrobenzene (10 μ L/mL)
Injection: 20 μ L

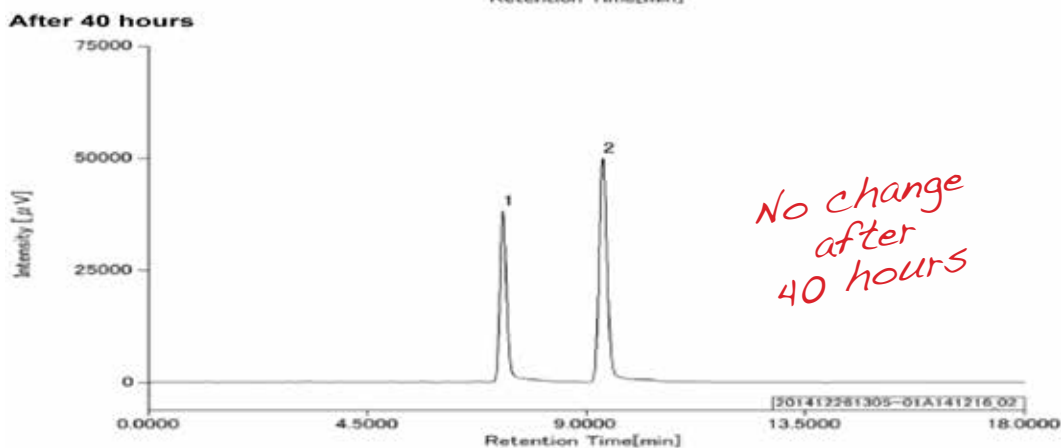
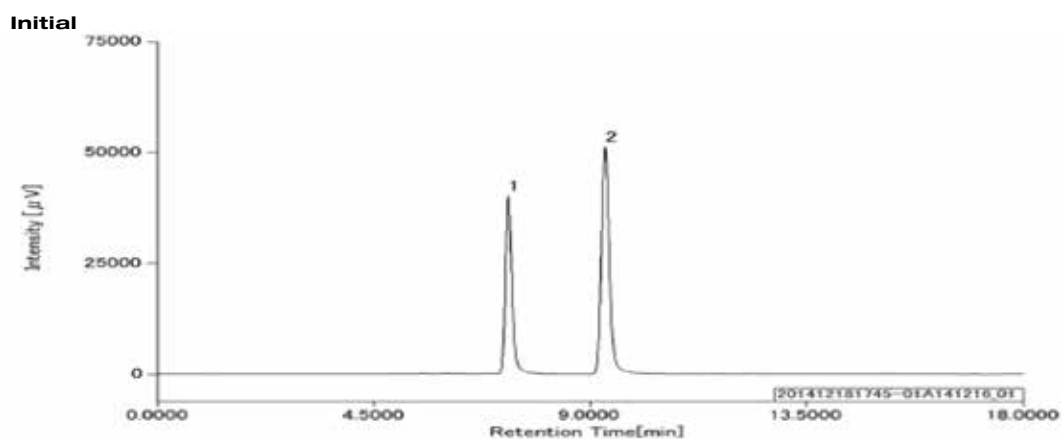

Step	Theoretical plate number N*	Tailing factor Tf*	Backpressure (bar)
Initial	16,093	1.18	20
After 40 h	15,693	1.16	22

*values for nitrobenzene (peak 2)

YMC-Actus

Secured hardware stability

The inlet frit was inspected after 40 and 80 hours. On opening, neither frit distortion nor gel leakage was observed.

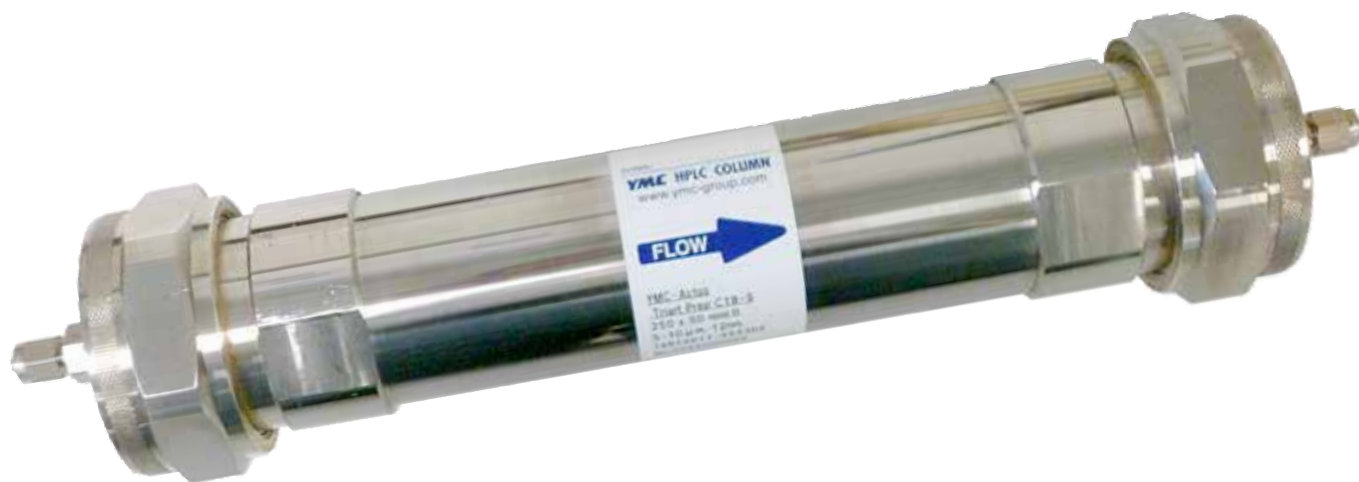

*YMC-Actus columns
remain stable
even after use
at maximum pressure!*

YMC-Actus



Effective method development on purification

In order to develop a successful semi-preparative method it is beneficial to proceed the following steps:

- Step 1: Developing a well optimised separation on analytical scale**
- Step 2: Loading study on analytical scale**
- Step 3: Scale-up to semi-preparative column dimensions**
- Step 4: Quality Control**

Linear Scale-Up

$$SF = \frac{\Pi_{ID, prep}^2}{\Pi_{ID, anal.}^2} = \frac{m_{prep}}{m_{anal.}}$$

$$SF = r_{ID, prep}^2 / r_{ID, analytical}^2$$

$$SF = 20^2_{ID, prep} / 4.6^2_{ID, analytical}$$

$$SF = 18.9$$

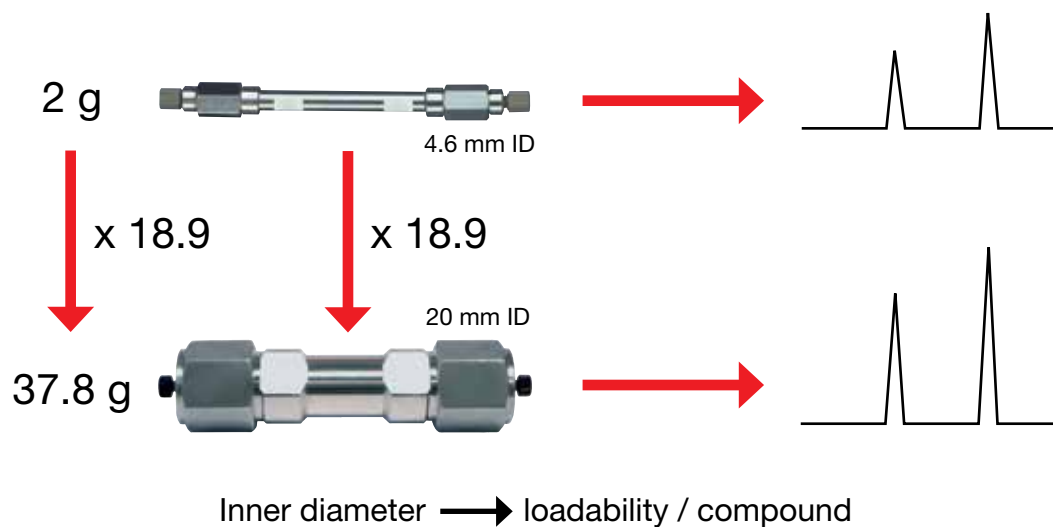

Guideline for Sample Load according to column ID

Column ID (mm)	Scale-Up factor	Loadability (mg)
4.6	1	1-4
10	4.7	5-20
20	18.9	20-80
50	118	80-350
75	266	270-980
100	472	470-1900
150	1060	1000-4200

YMC-Actus

Example: Separation of Clindamycin as basic drug

Step 1: Development of analytical method

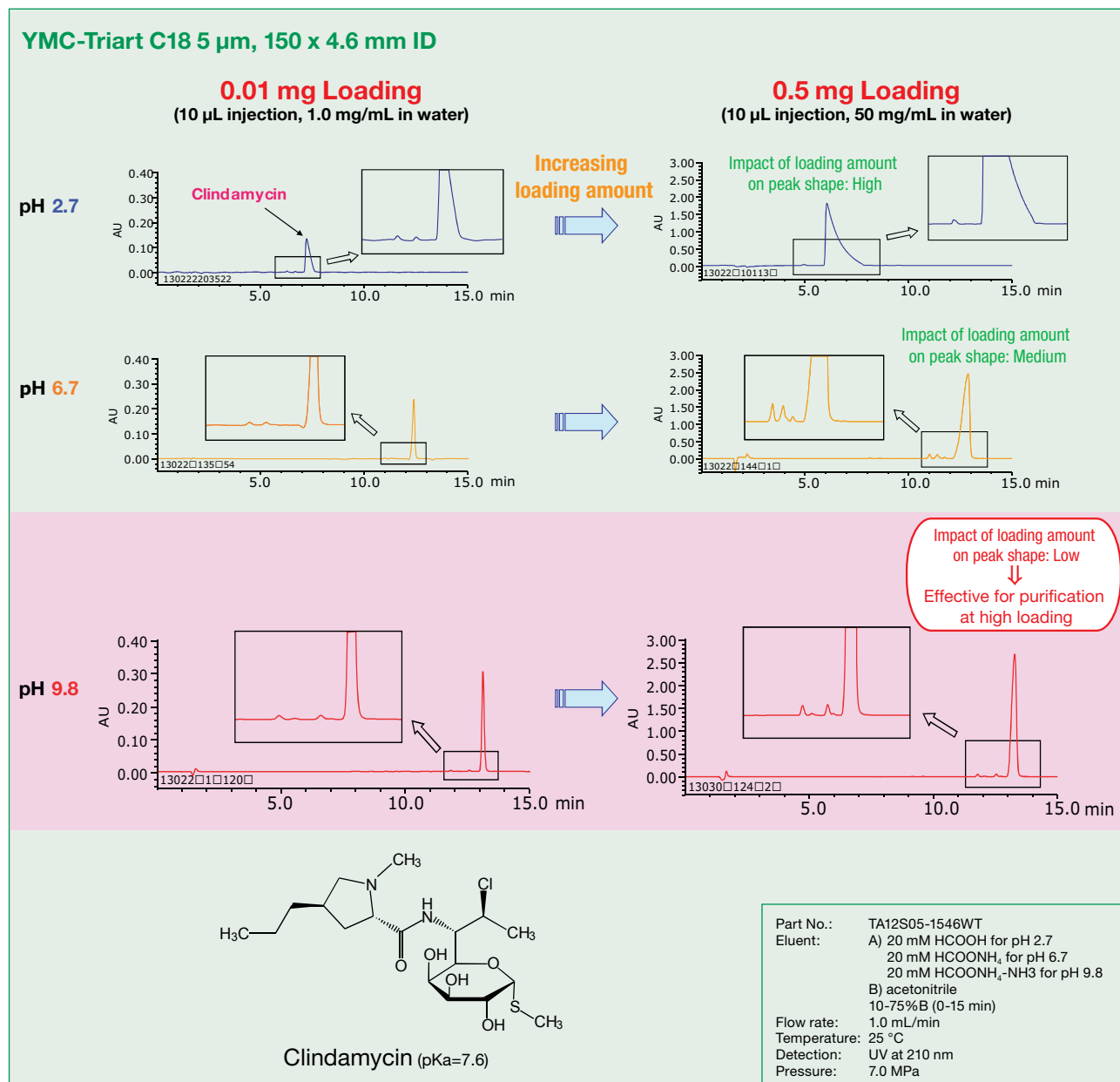

YMC-Actus

Step 2: Loading study for Clindamycin

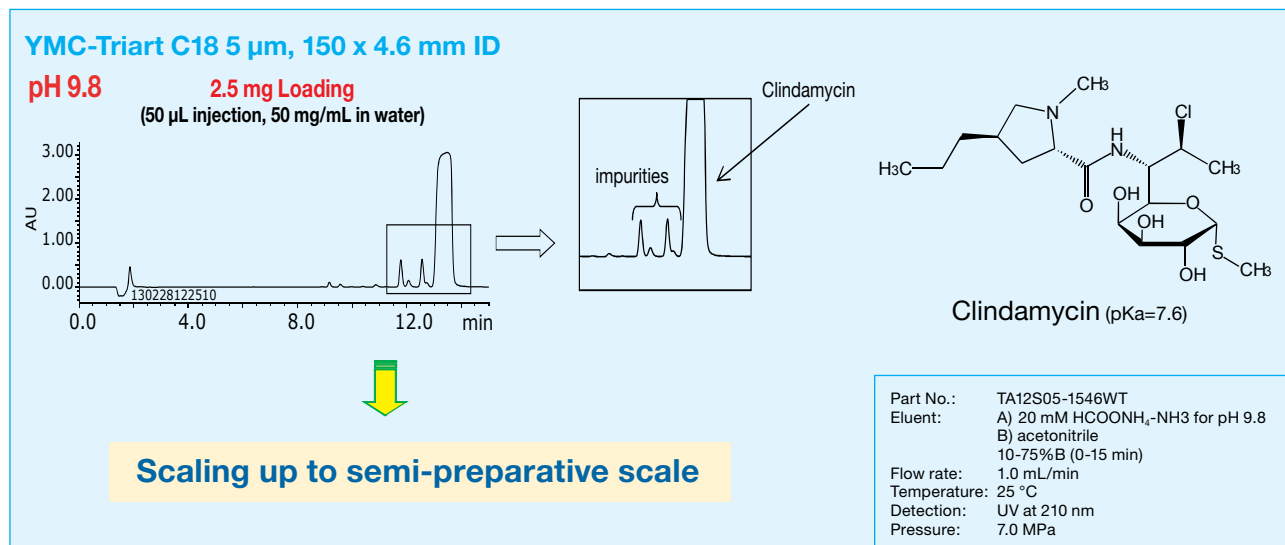

Step 3: Scale-up

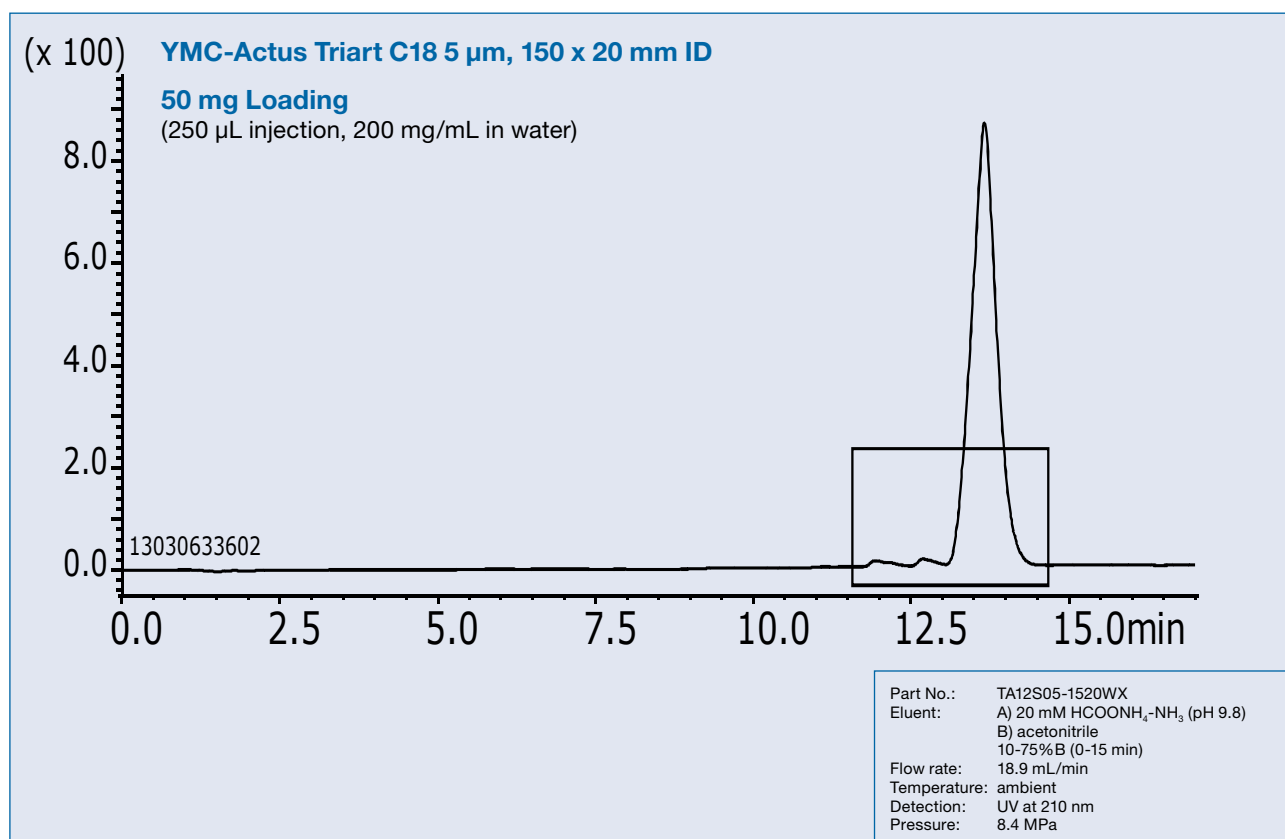

YMC-Actus

Step 4: Quality Control/Proof of concept

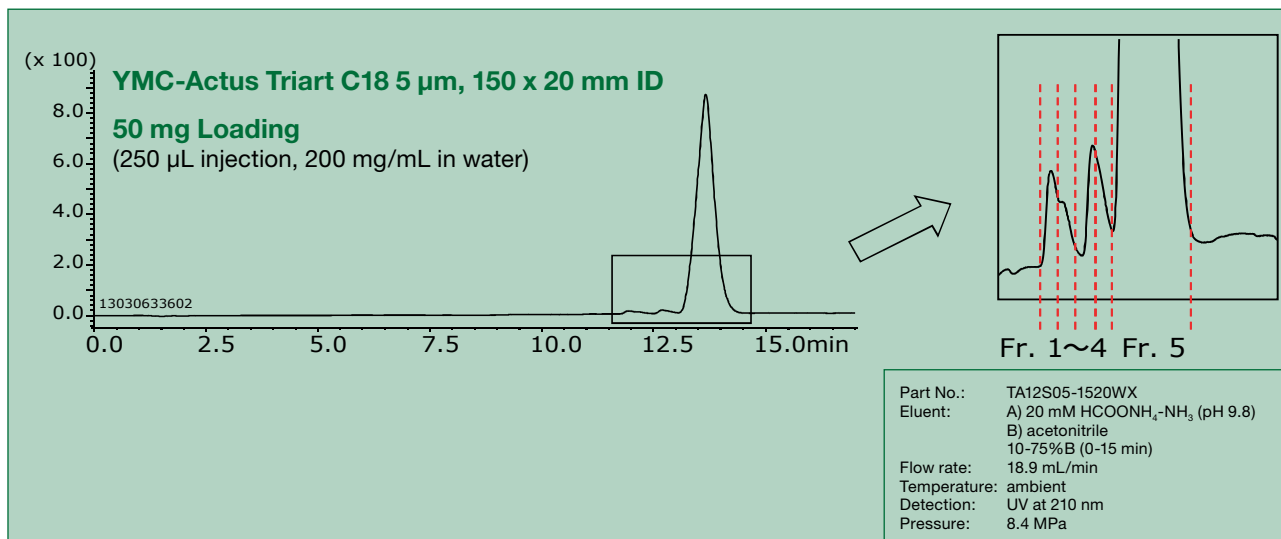

Analysis of fractions

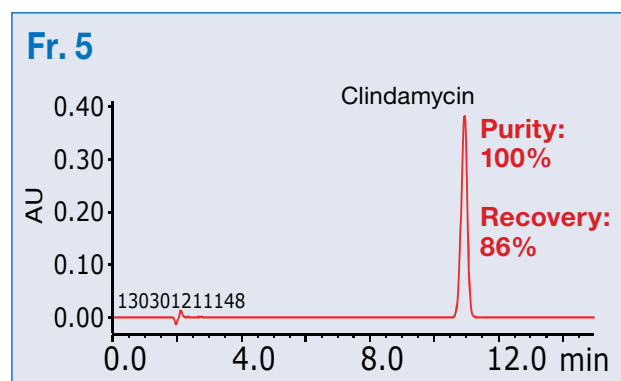
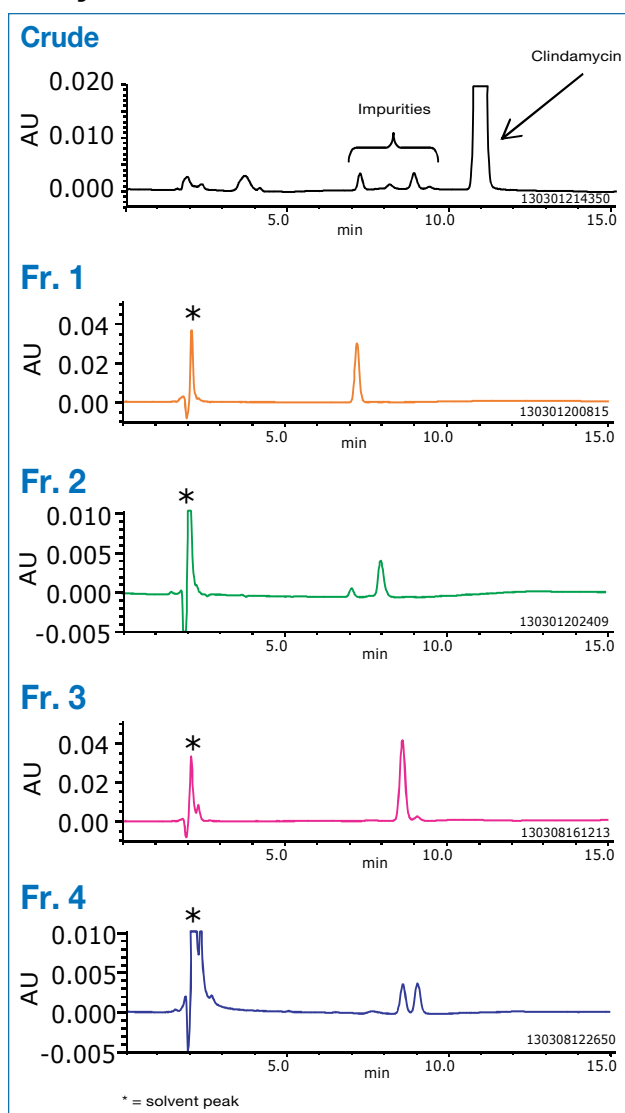

Column: YMC-Triart C18 5 μm, 150 x 4.6 mm ID
 Part No.: TA12S05-1546WT
 Eluent: 50 mM KH₂PO₄ (pH 7.5 adjusted by 8 M KOH)/acetonitrile (55/45)
 Flow rate: 1.0 mL/min
 Temperature: 25 °C
 Detection: UV at 210 nm
 Injection: 20 μL

YMC-Actus

Excellent stability and efficiency under fast gradient conditions at high flow rate

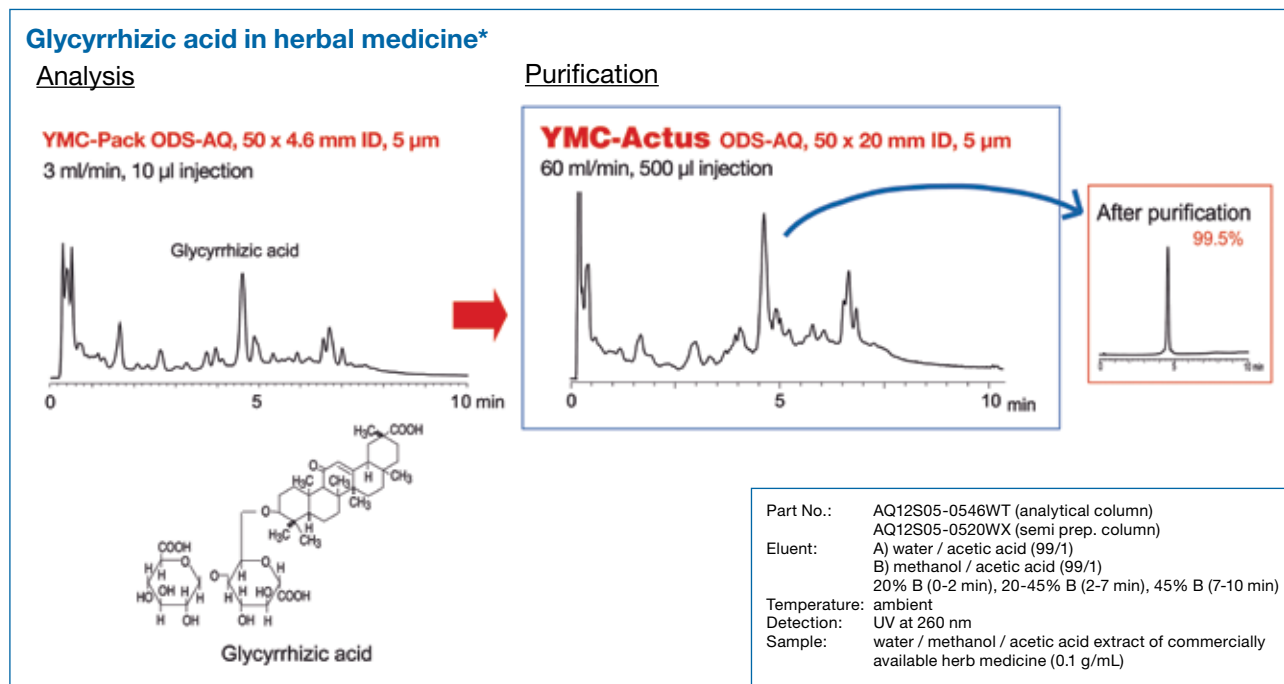

Available for high-throughput purification: Injection in DMSO

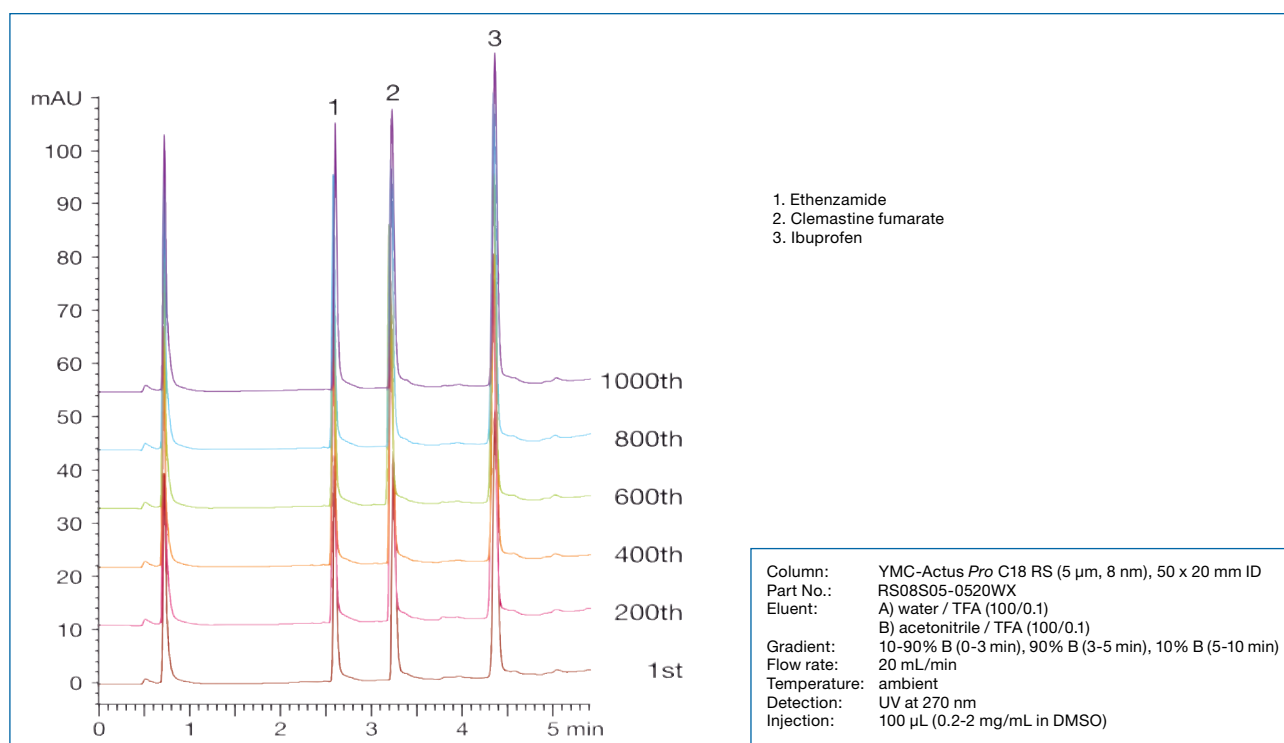

As shown in this overlay of chromatograms, YMC-Actus columns provide outstanding stability and reproducibility for the separation of pharmaceuticals dissolved in 100% DMSO, even after 1,000 injections under the test conditions. This verifies that YMC-Actus columns are ideal for high-throughput purification in drug discovery.

YMC-Actus

Excellent separation of compounds with similar structure

Capsaicinoids in red pepper*

Analysis 50 x 4.6 mm ID, 5 µm
2.0 mL/min, 20 µL injection

Phenomenex Luna C18

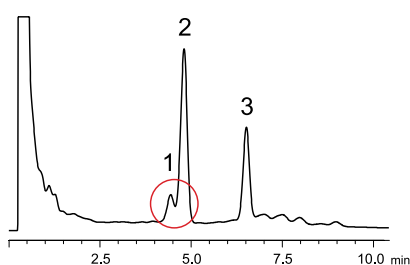

Waters XBridge C18

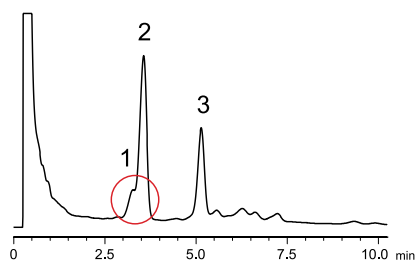

YMC-Pack Pro C18 RS

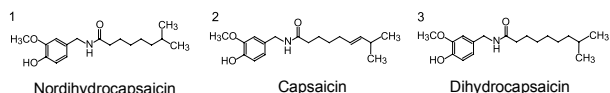
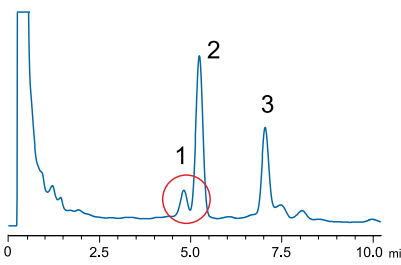

Purification



YMC-Actus Pro C18 RS, 50 x 20 mm ID 5 µm

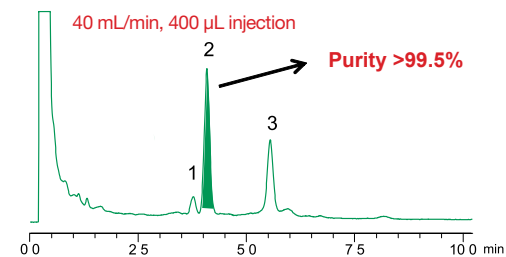

Eluent: A) methanol / water / TFA (50/50/0.1)
B) methanol / TFA (100/0.1)
0-30% B (0-5 min), 30% B (5-10 min)
Temperature: 25 °C for 50 x 4.6 mm ID
ambient for 50 x 20 mm ID
Detection: UV at 280 nm
Sample: methanol extract of a commercial red pepper (1 g / 3 mL)

Outstanding separation of highly polar compounds

Crude synthetic 30mer oligonucleotide*

Analysis 1.0 mL/min, 5 µL injection

Purification 19 mL/min, 100 µL injection

Hydrosphere C18

50 x 4.6 mm ID, 5 µm

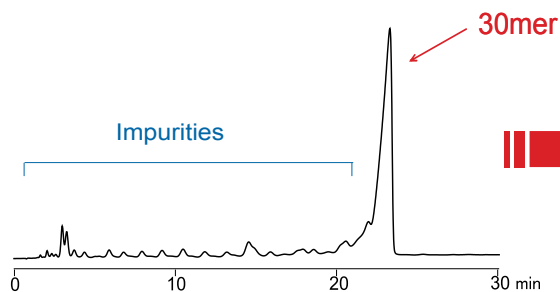

YMC-Actus Hydrosphere C18

50 x 20 mm ID, 5 µm

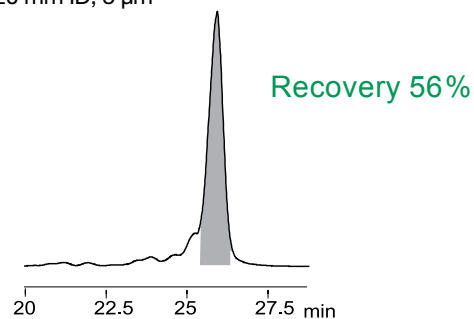

Part No.: HS12S05-0546WT (analytical column)
HS12S05-0520WX (semi prep. column)
Eluent: A) 10 mM DBA-acetic acid (pH 6.0) / methanol (60/40)
B) 10 mM DBA-acetic acid (pH 6.0) / methanol (20/80)
10-35% B (0-30 min)
Temperature: ambient
Detection: UV at 269 nm
Sample: synthetic oligonucleotide (100 µM)

■ purity >99%



YMC Actus

Preparative Column Selection Finder

Optimisation of preparative chromatography!

The main task for a preparative chromatographer is to find the most suitable system as quickly as possible. In order to simplify the process YMC has developed a "Preparative Column Selection Guide".

		High ← Column efficiency ^{※1} Pressure ^{※1} Cost ^{※1} → Low					
Standard sample load	Particle size (µm) Inner diameter (mm ID)	spherical					Irregular
		5 N = 90000 ^{※2}	10 N = 40000 ^{※2}	15 N = 20000 ^{※2}	20 N = 10000 ^{※2}	50 N = 5000 ^{※2}	230/70 mesh N = 2500 ^{※2}
For investigation	4, 6, 6.0	○	○	○	○	○	○
tens-of-mg	10, 20	○	○	○	○	○	○
hundreds-of-mg	50	○	○	○	○	○	○
g	100, 150		○	○	○	○	○
tens-of-g	200			○	○	○	○
hundreds-of-g	300 or more				○	○	○

 Most appropriate
  Appropriate
  According to the purpose

^{※1} Value per unit length
^{※2} Standard theoretical plate number per m

R&D Scale-up Kit: Analytical and semipreparative columns packed with a stationary phase from the same lot.

The "Preparative Column Selection Guide" will help in the selection of:-

1. the most suitable column ID for the required sample loading
2. the appropriate particle size for optimum efficiency
3. the required column length for the necessary resolution

R&D Kits

To minimise the problems that the process of scale-up may introduce, YMC offers YMC R&D kits, which consist of one analytical column and one YMC-Actus column packed with exactly the same packing material from the same production lot. Therefore, no further method development is needed, just a simple linear scale-up calculation.

YMC Actus

Scale-Up

YMC linear scale-up is achieved in 4 steps:

1. Analytical scale method development.

Determine the optimum separation conditions by using analytical columns packed with different stationary phases and various elution conditions.

2. Consider the preparative scale. Select the particle size of the packing material and the inner diameter of column appropriate for the sample volume.

3. Optimise the separation conditions and perform loadability studies using analytical columns having inner diameters of 4.6 mm or 6.0 mm packed with the packing material selected for the preparative separation (i.e. a scout column). If the particle size of the packing material is the same as in the Step 1, this process can be omitted. If the preparative column is more than 100 mm ID, it is advisable to insert an intermediate step with a scout column of 20 mm ID in order to accurately predict loadability and calculate the running costs.

4. Proceed with the preparative separation with scale-up of chromatographic parameters such as flow rate/ column ID/ sample load as necessary.

The most demanding step in this process will be the scale-up of the chromatographic parameters in order to meet the preparative demands.

There are a number of scalable parameters: flow rate, column ID, sample load, tubing ID, sample injection concentration, volume of sample loop, consumption of solvent, dead volume, fraction mass, size of the detector cell.

How to adjust the scalable factors?

In order to simplify your scale-up the three most important scale-up factors are summarised.

Scalable factor SF	Internal Diameter "Linear Scale-Up"	Column length "Time"	Column length and ID "Volume"
	$SF = r_{ID, prep}^2 / r_{ID, anal.}^2$	$SF = l_{ID, prep} / l_{ID, anal.}$	$SF = (r_{ID, prep}^2 / r_{ID, anal.}^2) / (l_{ID, prep} / l_{ID, anal.})$
Impact	Flow rate Eluent composition	Retention time Cycle time Plate number	Amount of adsorbent

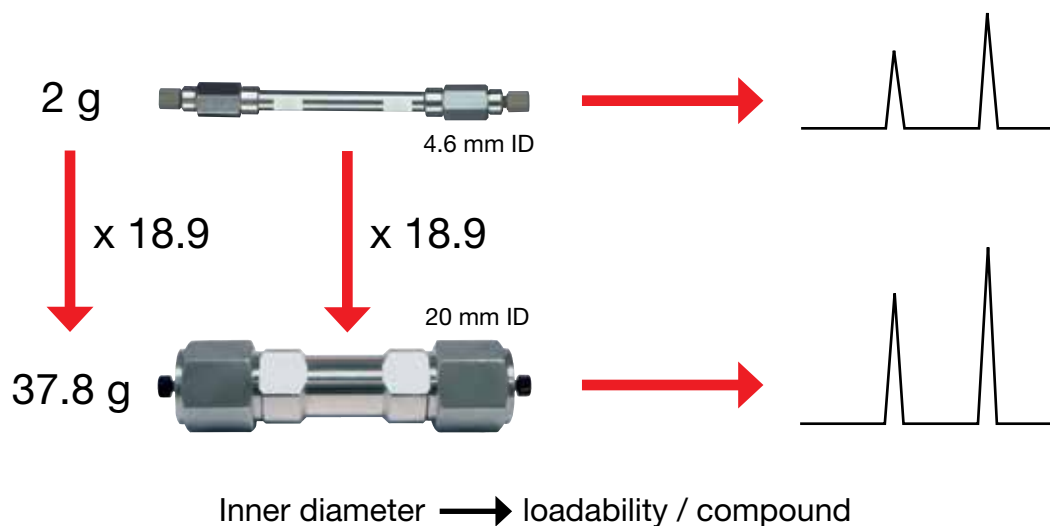

Ordering Information

High stability semi-preparative columns

Packing material	Particle size [µm]	Pore size [nm]	Column size length x ID [mm]	Product Code
YMC-Triart C18	5	12	50 x 20 100 x 20 150 x 20 250 x 20 50 x 30 75 x 30 100 x 30 150 x 30 250 x 30 100 x 50 150 x 50 250 x 50	TA12S05-0520WX TA12S05-1020WX TA12S05-1520WX TA12S05-2520WX TA12S05-0530WX TA12S05-L530WX TA12S05-1030WX TA12S05-1530WX TA12S05-2530WX on request on request on request
YMC-Triart C18 ExRS	5	8	50 x 20 100 x 20 150 x 20 250 x 20 50 x 30 75 x 30 100 x 30 150 x 30 250 x 30 100 x 50 150 x 50 250 x 50	TAR08S05-0520WX TAR08S05-1020WX TAR08S05-1520WX TAR08S05-2520WX TAR08S05-0530WX TAR08S05-L530WX TAR08S05-1030WX TAR08S05-1530WX TAR08S05-2530WX on request on request on request
YMC-Triart C8	5	12	50 x 20 100 x 20 150 x 20 250 x 20 50 x 30 75 x 30 100 x 30 150 x 30 250 x 30 100 x 50 150 x 50 250 x 50	T012S05-0520WX T012S05-1020WX T012S05-1520WX T012S05-2520WX T012S05-0530WX T012S05-L530WX T012S05-1030WX T012S05-1530WX T012S05-2530WX on request on request on request
YMC-Triart Phenyl	5	12	50 x 20 100 x 20 150 x 20 250 x 20 50 x 30 75 x 30 100 x 30 150 x 30 250 x 30 100 x 50 150 x 50 250 x 50	TPH12S05-0520WX TPH12S05-1020WX TPH12S05-1520WX TPH12S05-2520WX TPH12S05-0530WX TPH12S05-L530WX TPH12S05-1030WX TPH12S05-1530WX TPH12S05-2530WX on request on request on request
YMC-Triart PFP	5	12	50 x 20 100 x 20 150 x 20 250 x 20 50 x 30 75 x 30 100 x 30 150 x 30 250 x 30 100 x 50 150 x 50 250 x 50	TPF12S05-0520WX TPF12S05-1020WX TPF12S05-1520WX TPF12S05-2520WX TPF12S05-0530WX TPF12S05-L530WX TPF12S05-1030WX TPF12S05-1530WX TPF12S05-2530WX on request on request on request
YMC-Pack Pro C18	5	12	50 x 20 100 x 20 150 x 20 250 x 20 50 x 30 75 x 30 100 x 30 150 x 30 250 x 30 100 x 50 150 x 50 250 x 50	AS12S05-0520WX AS12S05-1020WX AS12S05-1520WX AS12S05-2520WX AS12S05-0530WX AS12S05-L530WX AS12S05-1030WX AS12S05-1530WX AS12S05-2530WX on request on request on request

Ordering Information

High stability semi-preparative columns

Packing material	Particle size [µm]	Pore size [nm]	Column size length x ID [mm]	Product Code
Hydrosphere C18	5	12	50 x 20	HS12S05-0520WX
			100 x 20	HS12S05-1020WX
			150 x 20	HS12S05-1520WX
			250 x 20	HS12S05-2520WX
			50 x 30	HS12S05-0530WX
			75 x 30	HS12S05-L530WX
			100 x 30	HS12S05-1030WX
			150 x 30	HS12S05-1530WX
			250 x 30	HS12S05-2530WX
			100 x 50	on request
			150 x 50	on request
			250 x 50	on request
YMC-Pack Pro C18 RS	5	8	50 x 20	RS08S05-0520WX
			100 x 20	RS08S05-1020WX
			150 x 20	RS08S05-1520WX
			250 x 20	RS08S05-2520WX
			50 x 30	RS08S05-0530WX
			75 x 30	RS08S05-L530WX
			100 x 30	RS08S05-1030WX
			150 x 30	RS08S05-1530WX
			250 x 30	RS08S05-2530WX
			100 x 50	on request
			150 x 50	on request
			250 x 50	on request
YMC-Pack Pro C8	5	12	50 x 20	OS12S05-0520WX
			100 x 20	OS12S05-1020WX
			150 x 20	OS12S05-1520WX
			250 x 20	OS12S05-2520WX
			50 x 30	OS12S05-0530WX
			75 x 30	OS12S05-L530WX
			100 x 30	OS12S05-1030WX
			150 x 30	OS12S05-1530WX
			250 x 30	OS12S05-2530WX
			100 x 50	on request
			150 x 50	on request
			250 x 50	on request
YMC-Pack ODS-A	5	12	50 x 20	AA12S05-0520WX
			100 x 20	AA12S05-1020WX
			150 x 20	AA12S05-1520WX
			250 x 20	AA12S05-2520WX
			50 x 30	AA12S05-0530WX
			75 x 30	AA12S05-L530WX
			100 x 30	AA12S05-1030WX
			150 x 30	AA12S05-1530WX
			250 x 30	AA12S05-2530WX
			100 x 50	on request
			150 x 50	on request
			250 x 50	on request
YMC-Pack ODS-AQ	5	12	50 x 20	AQ12S05-0520WX
			100 x 20	AQ12S05-1020WX
			150 x 20	AQ12S05-1520WX
			250 x 20	AQ12S05-2520WX
			50 x 30	AQ12S05-0530WX
			75 x 30	AQ12S05-L530WX
			100 x 30	AQ12S05-1030WX
			150 x 30	AQ12S05-1530WX
			250 x 30	AQ12S05-2530WX
			100 x 50	on request
			150 x 50	on request
			250 x 50	on request
YMCbasic	5	20	50 x 20	BA99S05-0520WX
			100 x 20	BA99S05-1020WX
			150 x 20	BA99S05-1520WX
			250 x 20	BA99S05-2520WX
			50 x 30	BA99S05-0530WX
			75 x 30	BA99S05-L530WX
			100 x 30	BA99S05-1030WX
			150 x 30	BA99S05-1530WX
			250 x 30	BA99S05-2530WX
			100 x 50	on request
			150 x 50	on request
			250 x 50	on request

Ordering Information

High stability semi-preparative columns

Packing material	Particle size [µm]	Pore size [nm]	Column size length x ID [mm]	Product Code
YMC-Triart Prep C18-S	10	12	50 x 20 100 x 20 150 x 20 250 x 20 50 x 30 75 x 30 100 x 30 150 x 30 250 x 30 100 x 50 150 x 50 250 x 50	TAS12S11-0520WX TAS12S11-1020WX TAS12S11-1520WX TAS12S11-2520WX TAS12S11-0530WX TAS12S11-L530WX TAS12S11-1030WX TAS12S11-1530WX TAS12S11-2530WX on request on request on request
YMC-Triart Prep C18-S	15	12	50 x 20 100 x 20 150 x 20 250 x 20 50 x 30 75 x 30 100 x 30 150 x 30 250 x 30 100 x 50 150 x 50 250 x 50	TAS12S16-0520WX TAS12S16-1020WX TAS12S16-1520WX TAS12S16-2520WX TAS12S16-0530WX TAS12S16-L530WX TAS12S16-1030WX TAS12S16-1530WX TAS12S16-2530WX on request on request on request
YMC-Triart Prep C18-S	20	12	50 x 20 100 x 20 150 x 20 250 x 20 50 x 30 75 x 30 100 x 30 150 x 30 250 x 30 100 x 50 150 x 50 250 x 50	TAS12S21-0520WX TAS12S21-1020WX TAS12S21-1520WX TAS12S21-2520WX TAS12S21-0530WX TAS12S21-L530WX TAS12S21-1030WX TAS12S21-1530WX TAS12S21-2530WX on request on request on request
YMC-Triart Prep C8-S	10	20	50 x 20 100 x 20 150 x 20 250 x 20 50 x 30 75 x 30 100 x 30 150 x 30 250 x 30 100 x 50 150 x 50 250 x 50	TOS20S11-0520WX TOS20S11-1020WX TOS20S11-1520WX TOS20S11-2520WX TOS20S11-0530WX TOS20S11-L530WX TOS20S11-1030WX TOS20S11-1530WX TOS20S11-2530WX on request on request on request
YMC-Triart Prep C8-S	15	20	50 x 20 100 x 20 150 x 20 250 x 20 50 x 30 75 x 30 100 x 30 150 x 30 250 x 30 100 x 50 150 x 50 250 x 50	TOS20S16-0520WX TOS20S16-1020WX TOS20S16-1520WX TOS20S16-2520WX TOS20S16-0530WX TOS20S16-L530WX TOS20S16-1030WX TOS20S16-1530WX TOS20S16-2530WX on request on request on request
YMC-Triart Prep C8-S	20	20	50 x 20 100 x 20 150 x 20 250 x 20 50 x 30 75 x 30 100 x 30 150 x 30 250 x 30 100 x 50 150 x 50 250 x 50	TOS20S21-0520WX TOS20S21-1020WX TOS20S21-1520WX TOS20S21-2520WX TOS20S21-0530WX TOS20S21-L530WX TOS20S21-1030WX TOS20S21-1530WX TOS20S21-2530WX on request on request on request

Ordering Information

High stability semi-preparative columns

Packing material	Particle size [µm]	Pore size [nm]	Column size length x ID [mm]	Product Code
YMC Omega	10	—	50 x 20 100 x 20 150 x 20 250 x 20 50 x 30 75 x 30 100 x 30 150 x 30 250 x 30 100 x 50 150 x 50 250 x 50	OMG99S11-0520WX OMG99S11-1020WX OMG99S11-1520WX OMG99S11-2520WX OMG99S11-0530WX OMG99S11-L530WX OMG99S11-1030WX OMG99S11-1530WX OMG99S11-2530WX on request on request on request

Guard cartridges

Packing material	Particle size [µm]	Pore size [nm]	Column size length x ID [mm]	Product Code [pack of 2]
YMC-Triart C18	5	12	10 x 20 10 x 30	TA12S05-0120CC TA12S05-0130CC
YMC-Triart C18 ExRS	5	8	10 x 20 10 x 30	TAR08S05-0120CC TAR08S05-0130CC
YMC-Triart C8	5	12	10 x 20 10 x 30	T012S05-0120CC T012S05-0130CC
YMC-Triart Phenyl	5	12	10 x 20 10 x 30	TPH12S05-0120CC TPH12S05-0130CC
YMC-Triart PFP	5	12	10 x 20 10 x 30	TPF12S05-0120CC TPF12S05-0130CC
YMC-Pack Pro C18	5	12	10 x 20 10 x 30	AS12S05-0120CC AS12S05-0130CC
Hydrosphere C18	5	12	10 x 20 10 x 30	HS12S05-0120CC HS12S05-0130CC
YMC-Pack Pro C18 RS	5	8	10 x 20 10 x 30	RS08S05-0120CC RS08S05-0130CC
YMC-Pack Pro C8	5	12	10 x 20 10 x 30	OS12S05-0120CC OS12S05-0130CC
YMC-Pack ODS-A	5	12	10 x 20 10 x 30	AA12S05-0120CC AA12S05-0130CC
YMC-Pack ODS-AQ	5	12	10 x 20 10 x 30	AQ12S05-0120CC AQ12S05-0130CC
YMCbasic	5	20	10 x 20 10 x 30	BA99S05-0120CC BA99S05-0130CC
Triart Prep C18-S	10	12	10 x 20 10 x 30	TAS12S11-0120CC TAS12S11-0130CC
	15	12	10 x 20 10 x 30	TAS12S16-0120CC TAS12S16-0130CC
	20	12	10 x 20 10 x 30	TAS12S21-0120CC TAS12S21-0130CC
Triart Prep C8-S	10	20	10 x 20 10 x 30	TOS20S11-0120CC TOS20S11-0130CC
	15	20	10 x 20 10 x 30	TOS20S16-0120CC TOS20S16-0130CC
	20	20	10 x 20 10 x 30	TOS20S21-0120CC TOS20S21-0130CC
Omega	10	—	10 x 20 10 x 30	OMG99S11-0120CC OMG99S11-0130CC

Guard cartridges holder: 20 mm guard column ID: XPCHSPW2; 30 mm guard column ID: XPCHSPW3



YMC HPLC COLUMN

AQ12S03-15H0AU
150 x 0.3 mm ID
Ser.-No. 9022917654



Contents

YMC Capillary Column Hardware.....	84-85
Gluten in Flour and Cookies	86-87
Allergens in Wine	88-89
Veterinary Drug Residues in Food	90-91
Ordering Information	92-93

Introduction

Miniaturisation of liquid chromatography in combination with mass spectrometry has several advantages including improvements in sensitivity, especially at low concentration levels and dramatically reduced solvent consumption, compared to conventional HPLC or UHPLC. With further method optimisation, run times can also be reduced giving further savings in solvent use or time.

To meet the requirements of MicroLC/CapillaryLC/NanoLC YMC offers capillary columns specifically designed to use with the corresponding chromatography systems.

YMC Capillary Column Hardware



Capillary columns

All YMC phases are available packed in capillary columns. They are compatible with all NanoLC/MicroLC/MS systems. Capillary columns are suitable for extremely low sample volumes and low flow rates. They are available either with 1/16" connections (10-32 thread) or with 1/32" connections (6-40 thread).

Pressure stability

Pressure stability of the phase is dependent on particle size:

2/3 μm : 550 bar / 7,975 psi

1.9 μm : 600 bar / 8,700 psi.

The hardware is pressure rated at
690 bar / 10,000 psi.

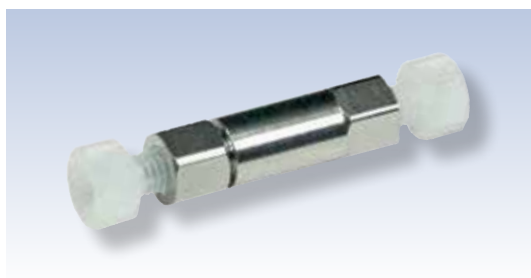

1/16" Guard column 5 mm x 300 μm

Guard columns

Guard columns are recommended for challenging matrices or for the use as trapping columns.

YMC Capillary Column Hardware

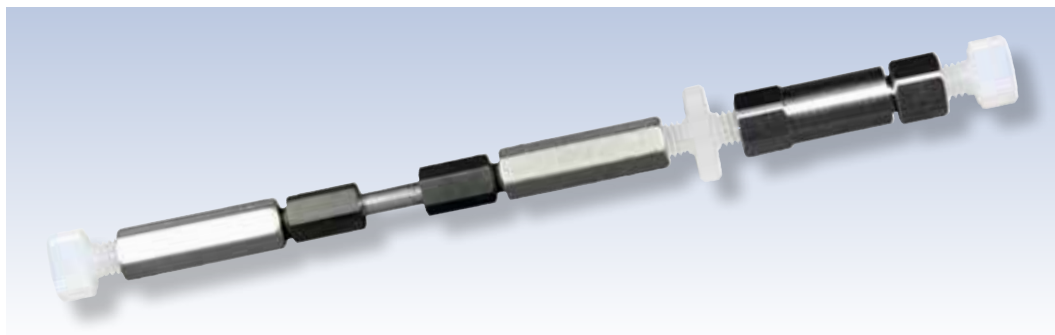

1/16" Guard column coupled to a 1/16" analytical column

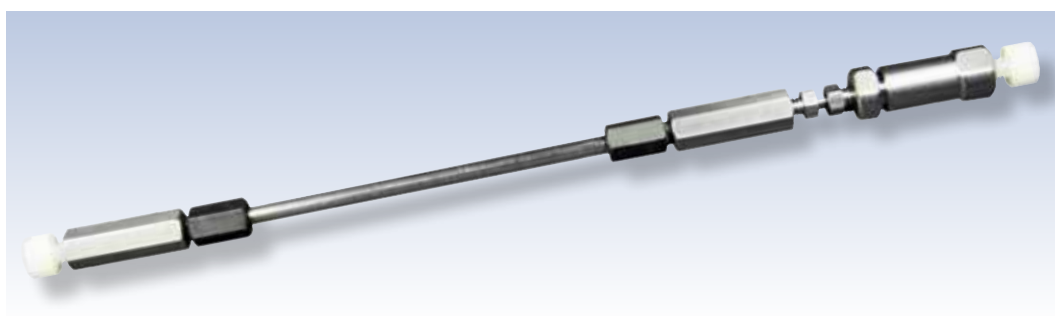

1/32" Guard column coupled to a 1/32" analytical column

Guard columns are connected directly to the analytical column using the column couplers supplied.

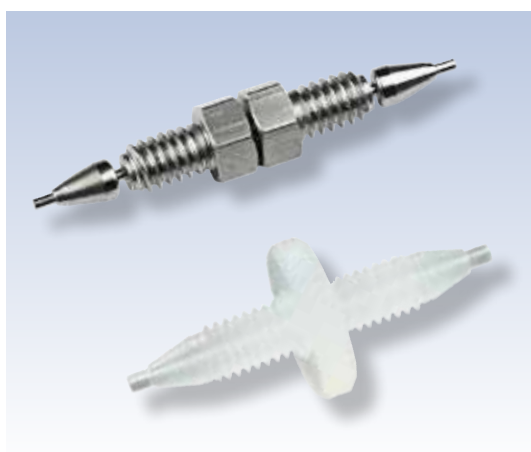

**1/32" (top), 1/16" (bottom)
Column coupler**

Column coupler

A column coupler is supplied with every pack of capillary guard cartridges to guarantee the optimum connection with low dead volume. A polymer-based (PCTFE) coupler is provided for 1/16" columns (bottom), while a stainless steel coupler is provided for 1/32" columns (top). Every coupler can be purchased separately if required.

Gluten in Flour and Cookies

Gluten and food safety

Gluten can cause allergic responses and even celiac disease if an intolerance occurs. The intolerance level is often depending on the gluten variety, which is relevant to the use of oats having low effect on celiac sufferers.

So far, ELISA based on R5 antibody detection is used. This assay can detect the presence of barley, rye and wheat, but cannot differentiate between them. It is not sensitive to oats. Further, it has the disadvantage of giving false positive or negative results due to either unspecific binding to the protein region or changes in the protein structure by processing.



MicroLC-MS/MS using YMC-Triart C18 capillary columns can not only detect gluten markers in processed food, but it can also distinguish between varieties.

Here, five different flour samples including a gluten-free and a supermarket self raising flour were analysed for wheat peptide markers. In all the flours except the gluten-free one, wheat peptide markers can be found.

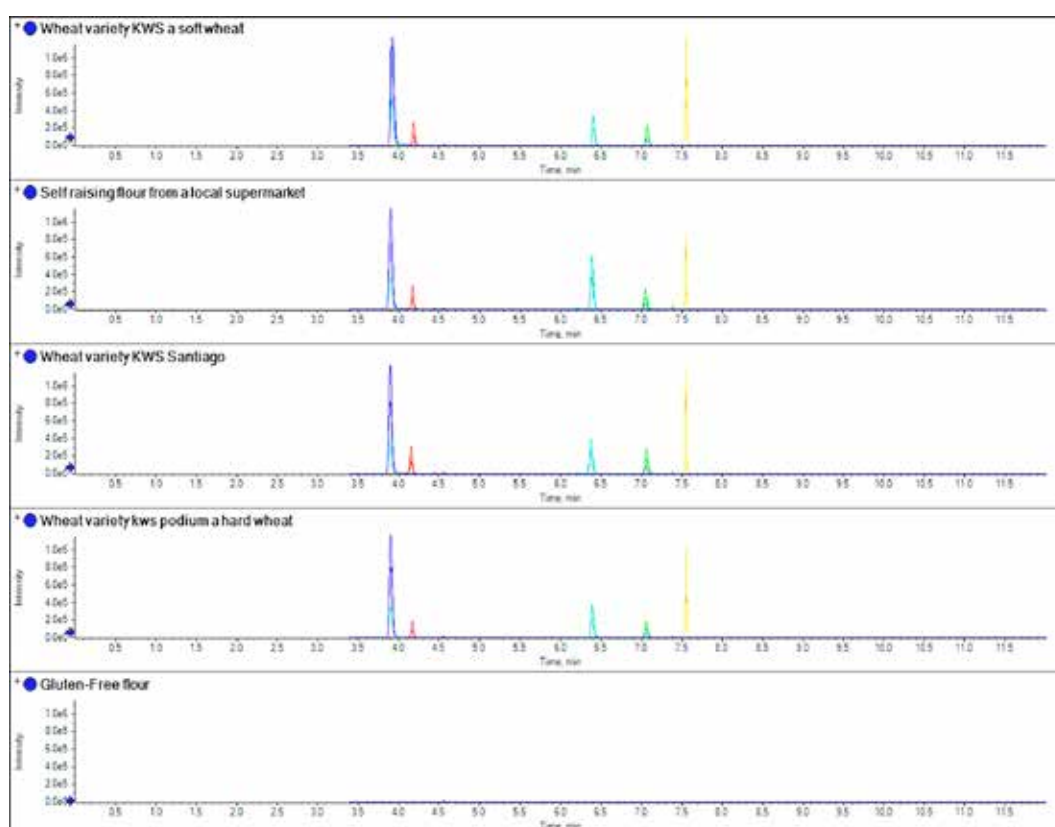

The comparison of separate extracts of several samples of wheat obtained from single variety grain samples, as well as a sample of gluten-free flour and the self raising flour obtained from a local supermarket.

Gluten in Flour and Cookies

With the help of MicroLC-MS/MS it is further possible to detect markers in processed food and also distinguish between varieties. In the oat cookies, wheat and oats markers were detected while in the wheat cookies only wheat peptide markers were found. The gluten-free products were actually gluten free, as no markers were detectable.

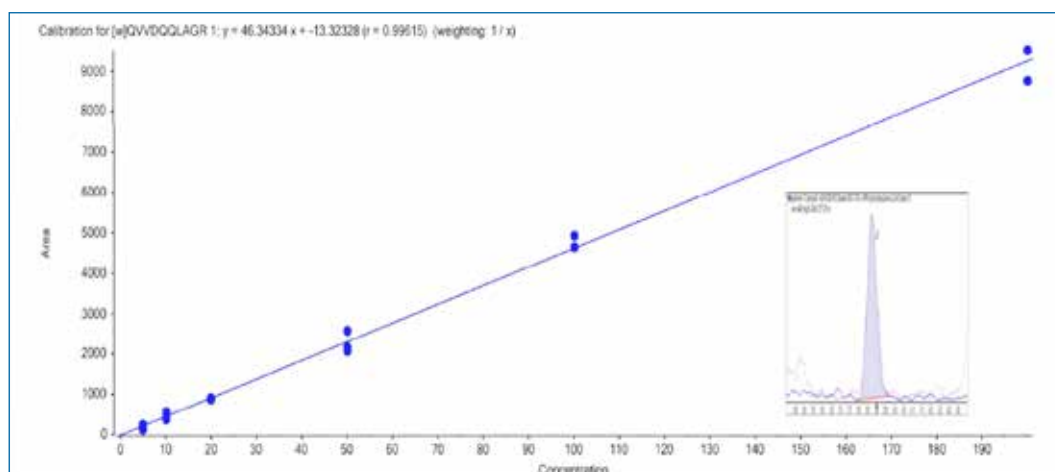
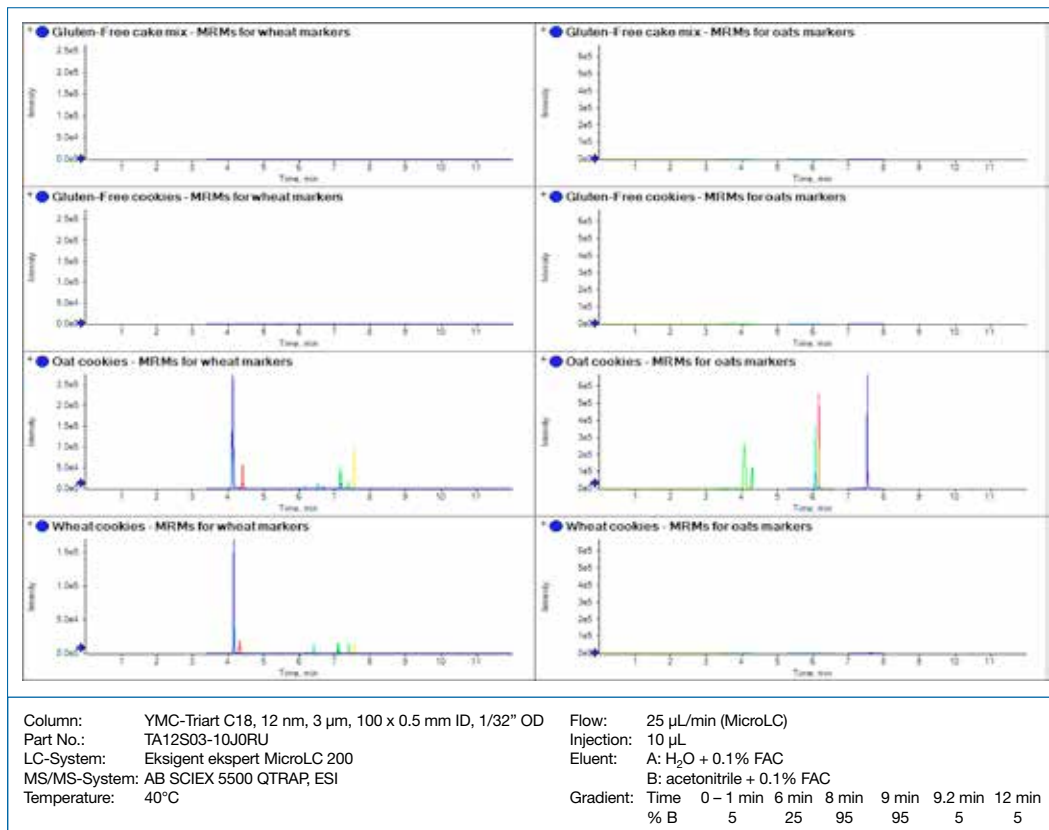

The calibration line obtained from the spiking of gliadin, a specific wheat protein, into gluten-free wheat from the range of 5–200 ppm for wheat peptide 3. Inlayed in the calibration line is the chromatogram for the 10 ppm spike of gliadin into gluten-free flour.

By courtesy of: Stephen Lock, AB SCIEX, Warrington (UK)

Literature:

Heick, J.; Fischer, M.; Pöpping, B. First screening method for the simultaneous detection of seven allergens by liquid chromatography mass spectrometry. *J. Chromatogr. A* 2011, 1218, 938–943.

Allergens in Wine

Food watch for wine

In response to a wine survey, where casein was found in trace amounts (<2 ppm), the European Food Safety Authority (EFSA) concluded, in 2011, that wine fined with casein, caseinate or milk products can cause adverse reactions in sensitive individuals. In addition, a new EU legislation (concerning labelling) pointed out that, if fining reagents such as casein, egg ovalbumin, etc. are used in processing, methods for detection of these products in wine are needed.

With this MicroLC method using a YMC-Triart C18 capillary column various milk and egg markers can be detected simultaneously in white wine. Due to a detection limit below 100 ppb, the requirements of detecting trace amounts are met.



The initial results for column selection show a typical sensitivity increase of between 4 and 12 fold in S/N-ratio when switching from high to micro flow. The results clearly demonstrate an improvement in sensitivity when moving to MicroLC which is not lost when the analysis time is further shortened to a runtime of 5.5 min to speed up the analysis. In addition, the reduced analysis time also reduces solvent consumption through the use of MicroLC.

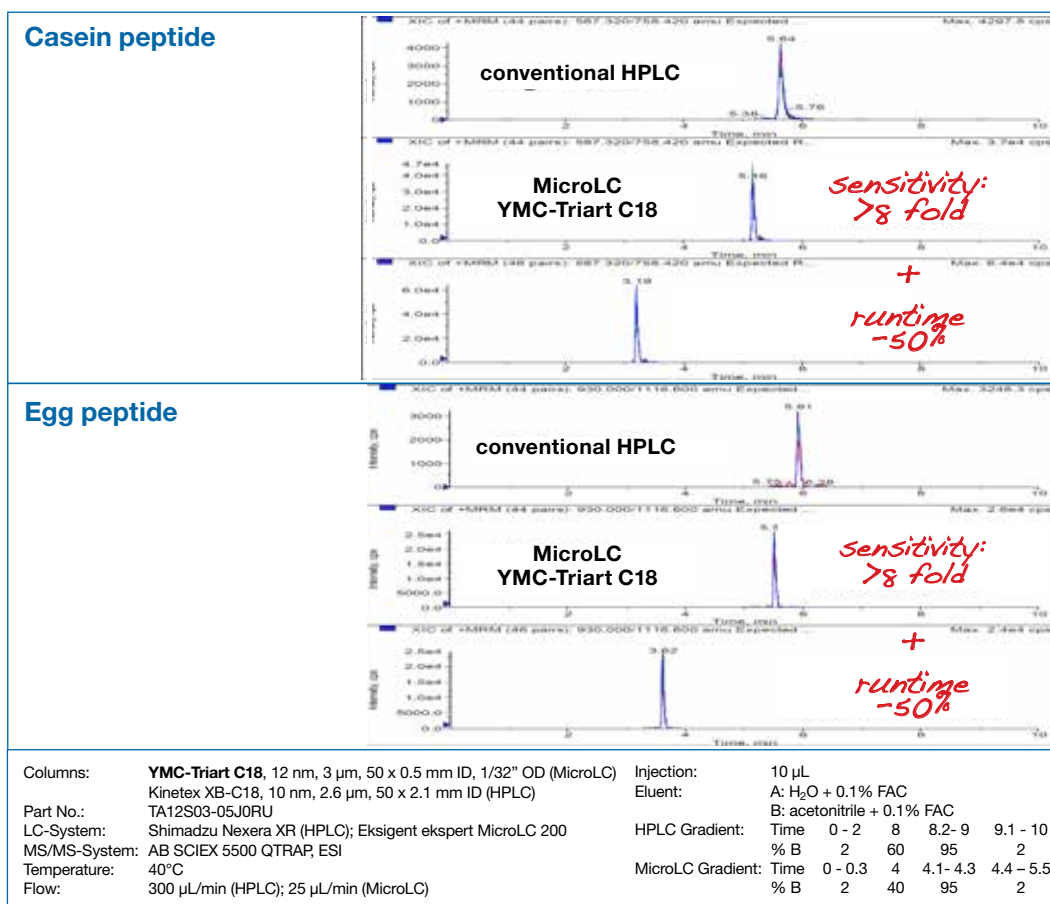

Comparison of HPLC vs. MicroLC using a white wine spiked with 1 ppm casein peptide (top) and an egg peptide (bottom).

Allergens in Wine

The LC-MS/MS approach has the additional advantage of being a potential multi allergen screen where different allergens, such as egg and milk, can be detected by a single method.

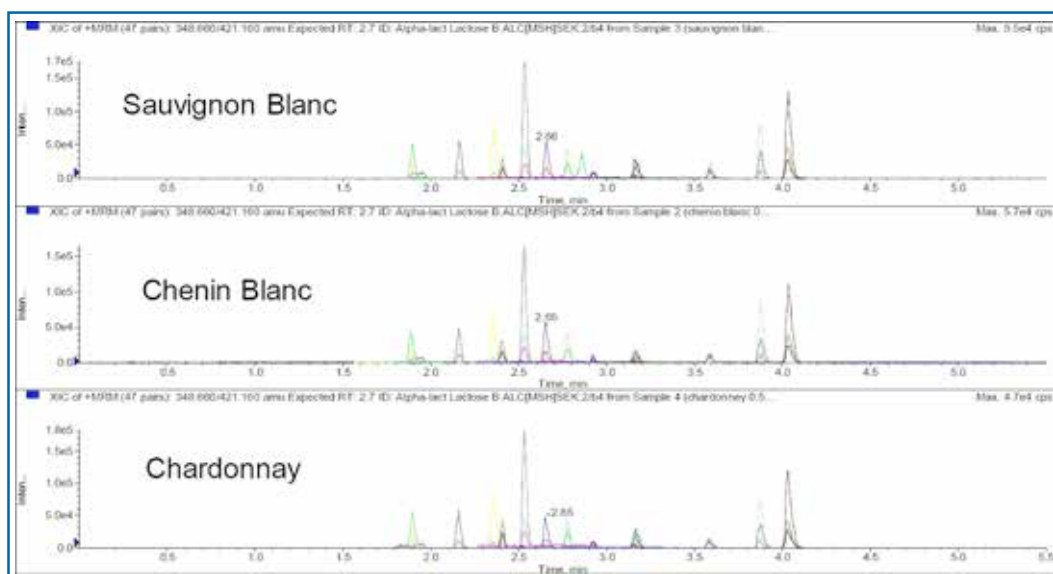

On the YMC-Triart C18 capillary column MicroLC-MS/MS analysis was performed. 3 different white wines spiked with 0.5 ppm samples of milk and egg proteins were analysed. Furthermore, it was possible to detect and identify several milk and egg proteins in one run.

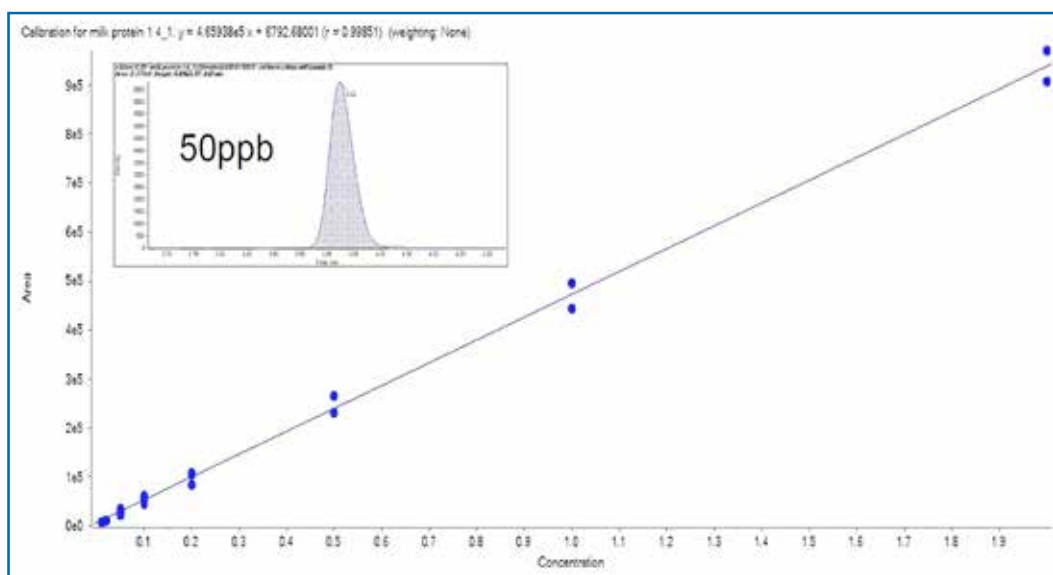

A casein peptide is spiked into a Sauvignon Blanc (0.05 – 2 ppm) to demonstrate linearity and sensitivity. Linearity is provided without use of any internal standards. The inset chromatogram for 50 ppb spiked sample demonstrates highest sensitivity.

By courtesy of: Stephen Lock, AB SCIEX, Warrington (UK)

Literature:

Scientific Opinion related to a notification from the International Organization of Vine and Wine on casein/caseinate/milk products to be used in the manufacture of wine as clarification processing aids pursuant to Article 6, paragraph 11 of Directive 200/13/EC – for permanent exemption from labelling, EFSA Journal 2011, 9(10), 2384.

Commission Regulation (EU) No 1266/2010 of 22 December 2010 amending Directive 2007/68/EC as regards labelling requirements for wines, 2010.

Veterinary Drug Residues in Food

Veterinary drug residues legislated in the EU

The levels and presence of veterinary drug residues in food of animal origin are legislated in the EU with limits often varying with the drug residue [4].

The MicroLC method on a YMC-Triart C18 capillary column easily fulfils the requirements of the current EU legislation. A gain in signal by a factor of more than 8-fold when switching from high to micro flow for some components is observed.

The chromatograms clearly demonstrate an improvement in sensitivity when moving to MicroLC. It is not lost when the analysis time of 10 min is further shortened to a run time of 3.5 min to speed up the analysis. Furthermore, the cut in analyse time provides great potential of cost savings by up to 90% in regards to solvents.

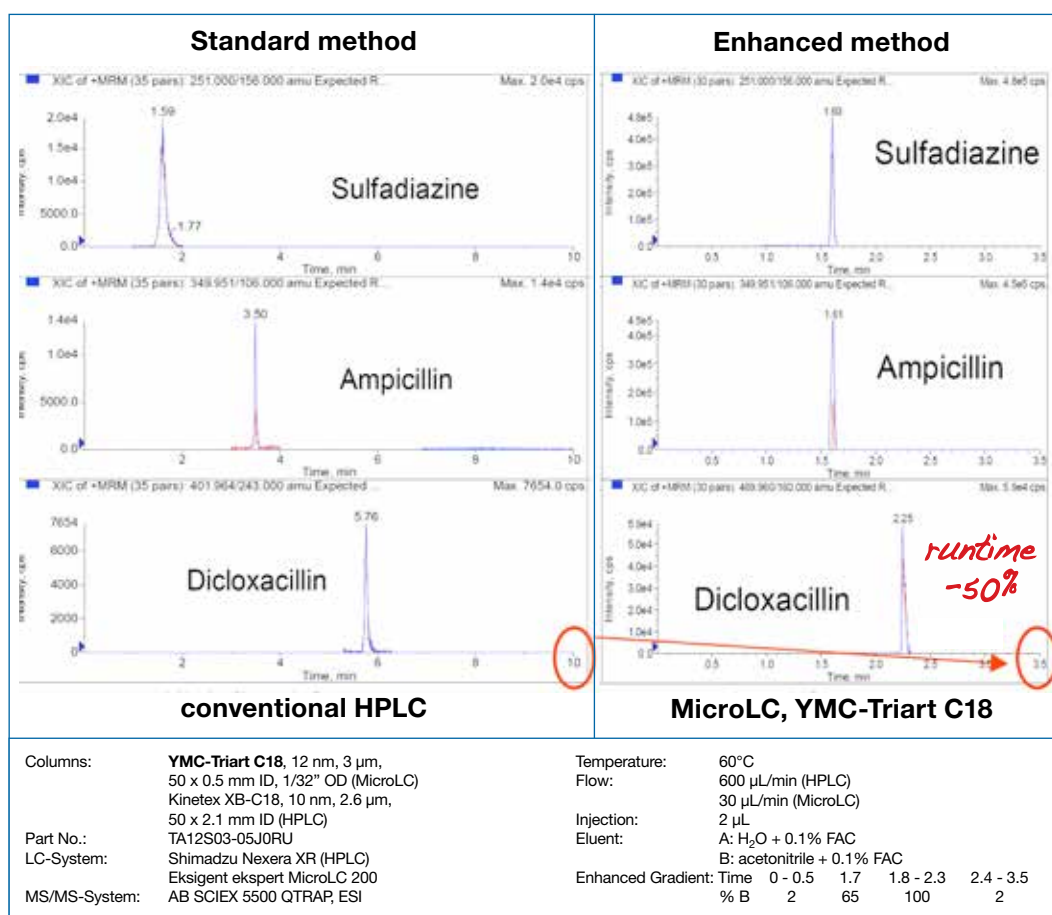

Comparison of 3 different 1 ppb standard solutions separated by a standard HPLC method using a Kinetex C18 column (left) and the MicroLC method using a YMC-Triart C18 capillary column (right).

Veterinary Drug Residues in Food

The MicroLC/MS/MS approach has the additional advantage of being a potential drug residue screen where different residues can be detected by a single method.

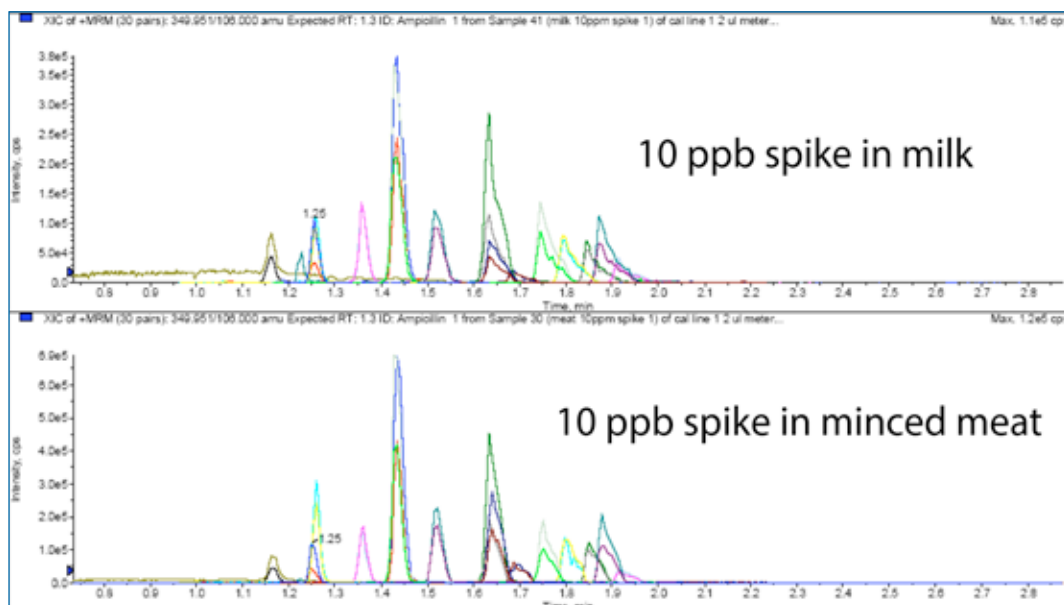

In the final analysis a total of 32 multiple reaction monitoring (MRM) transitions were evaluated for 15 veterinary drug residues over a 3.5 minute run time on the YMC-Triart C18 capillary column. Milk and meat samples have been spiked at a 10 ppb level with standard compounds. The recoveries from meat were generally higher and it shows that recoveries are affected by the matrix.

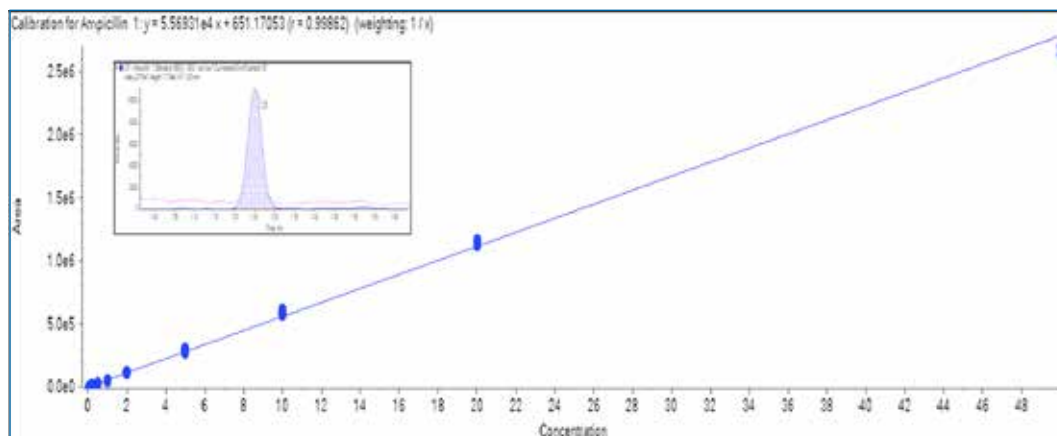

Linearity and sensitivity of this method is demonstrated for Ampicillin from 0.05 – 50 ppb. Linearity is provided without use of any internal standards. The inset chromatogram for a 0.5 ppb spiked sample demonstrates the high level of sensitivity.

By courtesy of: Stephen Lock, AB SCIEX, Warrington (UK)

Literature:

Commission Regulation (EU) No 37/2010 of 22 December 2010 on pharmacologically active substances and their classification regarding maximum residue limits in foodstuffs of animal origin, 2010.

Dimensions and Part Numbers

YMC capillary columns are available with 1/16" (10-32 thread) or with 1/32" (6-40 thread) connections. All column part numbers indicate the connection size by use of additional terminal letters:

1/16" fittings end with **AU**

1/32" fittings end with **RU**

The specific part number for a given column consists of two parts describing chemistry and dimension/hardware details. Both parts of the part number can be taken from the tables below:

First part (chemistry) of the part number

YMC-Triart Columns

Description	Partial Part No.
YMC-Triart C18 ExRS, 8 nm, 1.9 µm	TAR08SP9
YMC-Triart C18 ExRS, 8 nm, 3 µm	TAR08S03
YMC-Triart C18 ExRS, 8 nm, 5 µm	TAR08S05
YMC-Triart C18, 12 nm, 1.9 µm	TA12SP9
YMC-Triart C18, 12 nm, 3 µm	TA12S03
YMC-Triart C18, 12 nm, 5 µm	TA12S05
YMC-Triart C8, 12 nm, 1.9 µm	T012SP9
YMC-Triart C8, 12 nm, 3 µm	T012S03
YMC-Triart C8, 12 nm, 5 µm	T012S05
YMC-Triart Diol-HILIC, 12 nm, 1.9 µm	TDH12SP9
YMC-Triart Diol-HILIC, 12 nm, 3 µm	TDH12S03
YMC-Triart Diol-HILIC, 12 nm, 5 µm	TDH12S05
YMC-Triart PFP, 12 nm, 1.9 µm	TPF12SP9
YMC-Triart PFP, 12 nm, 3 µm	TPF12S03
YMC-Triart PFP, 12 nm, 5 µm	TPF12S05
YMC-Triart Phenyl, 12 nm, 1.9 µm	TPH12SP9
YMC-Triart Phenyl, 12 nm, 3 µm	TPH12S03
YMC-Triart Phenyl, 12 nm, 5 µm	TPH12S05

YMC ProFamily columns

Description	Partial Part No.
YMC-UltraHT Pro C18, 12 nm, 2 µm	AS12S02
YMC-Pack Pro C18, 12 nm, 3 µm	AS12S03
YMC-Pack Pro C18, 12 nm, 5 µm	AS12S05
YMC-UltraHT Hydrosphere C18, 12 nm, 2 µm	HS12S02
Hydrosphere C18, 12 nm, 3 µm	HS12S03
Hydrosphere C18, 12 nm, 5 µm	HS12S05
YMC-Pack Pro C8, 12 nm, 3 µm	OS12S03
YMC-Pack Pro C8, 12 nm, 5 µm	OS12S05
YMC-Pack Pro C4, 12 nm, 3 µm	BS12S03
YMC-Pack Pro C4, 12 nm, 5 µm	BS12S05
YMC-Pack Pro C18 RS, 8 nm, 3 µm	RS08S03
YMC-Pack Pro C18 RS, 8 nm, 5 µm	RS08S05

Important Note:

For use with Eksigent Micro- and NanoLC systems, order columns with 1/32" (6-40 thread) end-fitting and use either Eksigent 6/40 fitting p/n 5019621 or VALCO p/n ZNF.5FPK.

Dimensions and Part Numbers

A selection of other YMC columns*

Description	Partial Part No.	Description	Partial Part No.
YMC-Pack ODS-A, 12 nm, 5 µm	AA12S05	YMC-Pack TMS (C1), 12 nm, 5 µm	TM12S05
YMC-Pack ODS-A, 20 nm, 5 µm	AA20S05	YMC-Pack CN (Cyano), 12 nm, 5 µm	CN12S05
YMC-Pack ODS-A, 30 nm, 5 µm	AA30S05	YMC-Pack CN (Cyano), 30 nm, 5 µm	CN30S05
YMC-Pack ODS-AQ, 12 nm, 5 µm	AQ12S05	YMC-Pack Diol-NP, 6 nm, 5 µm	DN06S05
YMC-Pack ODS-AQ, 20 nm, 5 µm	AQ20S05	YMC-Pack Diol-NP, 12 nm, 5 µm	DN12S05
J'sphere H80, 8 nm, 4 µm	JH08S04	YMC-Pack Diol-NP, 20 nm, 5 µm	DN20S05
J'sphere M80, 8 nm, 4 µm	JM08S04	YMC-Pack Diol-NP, 30 nm, 5 µm	DN30S05
J'sphere L80, 8 nm, 4 µm	JL08S04	YMC-Pack NH ₂ (Amino), 12 nm, 5 µm	NH12S05
YMC-Pack C8 (Octyl), 20 nm, 5 µm	OC20S05	YMC-Pack Polyamine II, 12 nm, 5 µm	PB12S05
YMC-Pack C8 (Octyl), 30 nm, 5 µm	OC30S05	YMC-Pack PVA-Sil, 12 nm, 5 µm	PV12S05
YMCbasic, 20 nm, 3 µm	BA99S03	YMC-Pack SIL (Silica), 6 nm, 5 µm	SL06S05
YMCbasic, 20 nm, 5 µm	BA99S05	YMC-Pack SIL (Silica), 12 nm, 5 µm	SL12S05
YMC-Pack C4 (Butyl), 20 nm, 5 µm	BU20S05	YMC-Pack SIL (Silica), 20 nm, 5 µm	SL20S05
YMC-Pack C4 (Butyl), 30 nm, 5 µm	BU30S05	YMC-Pack SIL (Silica), 30 nm, 5 µm	SL30S05
YMC-Pack Ph (Phenyl), 12 nm, 5 µm	PH12S05		
YMC-Pack Ph (Phenyl), 30 nm, 5 µm	PH30S05		
YMC Carotenoid (C30), 3 µm	CT99S03		
YMC Carotenoid (C30), 5 µm	CT99S05		

*Other YMC phases are available on request

Second part (dimension/hardware) of the part number

Column ID [µm]	Fitting [inch]	Column length				5 mm [guard column] pack of 3
		50 mm	75 mm	100 mm	150 mm	
75	1/32	-05E8RU	-L5E8RU	-10E8RU	-15E8RU	—
100	1/32	-05F0RU	-L5F0RU	-10F0RU	-15F0RU	—
300	1/32	-05H0RU	-L5H0RU	-10H0RU	-15H0RU	-E5H0RU
500	1/32	-05J0RU	-L5J0RU	-10J0RU	-15J0RU	-E5J0RU
75	1/16	-05E8AU	-L5E8AU	-10E8AU	-15E8AU	—
100	1/16	-05F0AU	-L5F0AU	-10F0AU	-15F0AU	—
300	1/16	-05H0AU	-L5H0AU	-10H0AU	-15H0AU	-E5H0AU
500	1/16	-05J0AU	-L5J0AU	-10J0AU	-15J0AU	-E5J0AU

Example: Triart C18, 12 nm, 5 µm, 100 mm x 300 µm, 1/16" => TA12S05-10H0AU

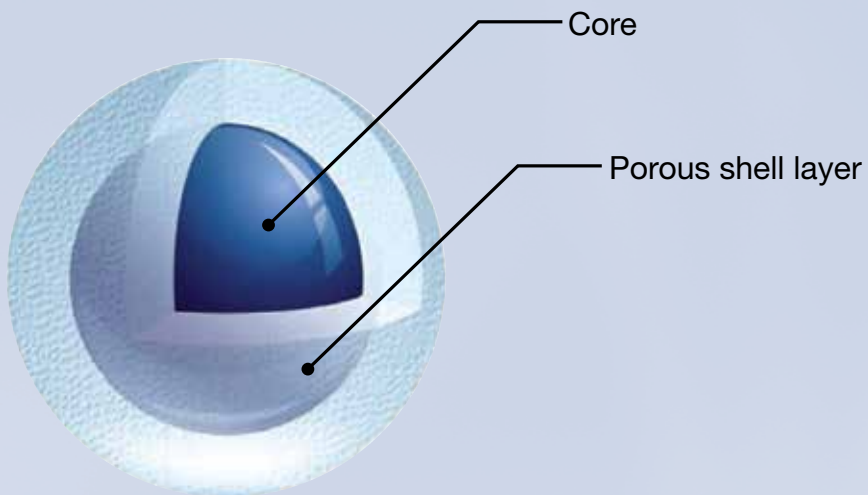

Meteoric Core

Particle Image Structure





Contents

Features and Specifications	96
Selectivity Chart	97
Applications	98-100
QC-Data	101
Ordering Information.....	102

Introduction

Core Shell Columns for UHPLC and HPLC

Meteoric Core is a core-shell material optimised for ultra fast separations with outstanding resolution. Excellent peak shapes for basic and coordinating compounds are possible due to a large pH-range of 1.5 to 10 (to pH 9 for C8). It is also an ideal choice for LC/MS applications due to low column bleeding.

Core-Shell columns for UHPLC & HPLC

- ultra fast separation with outstanding resolution
- excellent peak shape for basic and coordinating compounds
- wide pH application range
- low column bleed, ideal for LC/MS



Specifications	Meteoric Core C18	Meteoric Core C18 BIO	Meteoric Core C8
Base particle	Core-Shell type silica gel		
Particle size / μm	2.7	2.7	2.7
Pore size / nm	8	16	8
Specific surface area / m^2/g	150	90	150
Bonding	Trifunctional	Trifunctional	Trifunctional
Carbon content / %	7	5	5
End capping	Yes	Yes	Yes
Pressure limit	60 MPa / 8700 psi	60 MPa / 8700 psi	60 MPa / 8700 psi
pH range	1.5-10	1.5-10	1.5-9
Temperature	70 °C (< pH 7), 50 °C (> pH 7)	70 °C (< pH 7), 50 °C (> pH 7)	60 °C (< pH 7), 40 °C (> pH 7)
USP Classification	L1	L1	L7

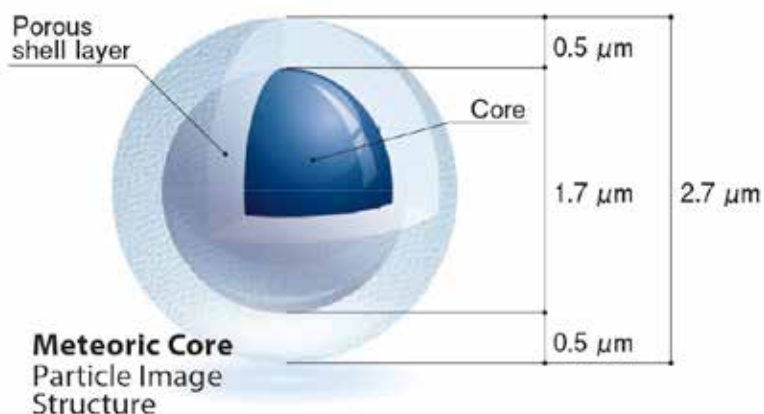

Meteoric Core

Selectivity Chart

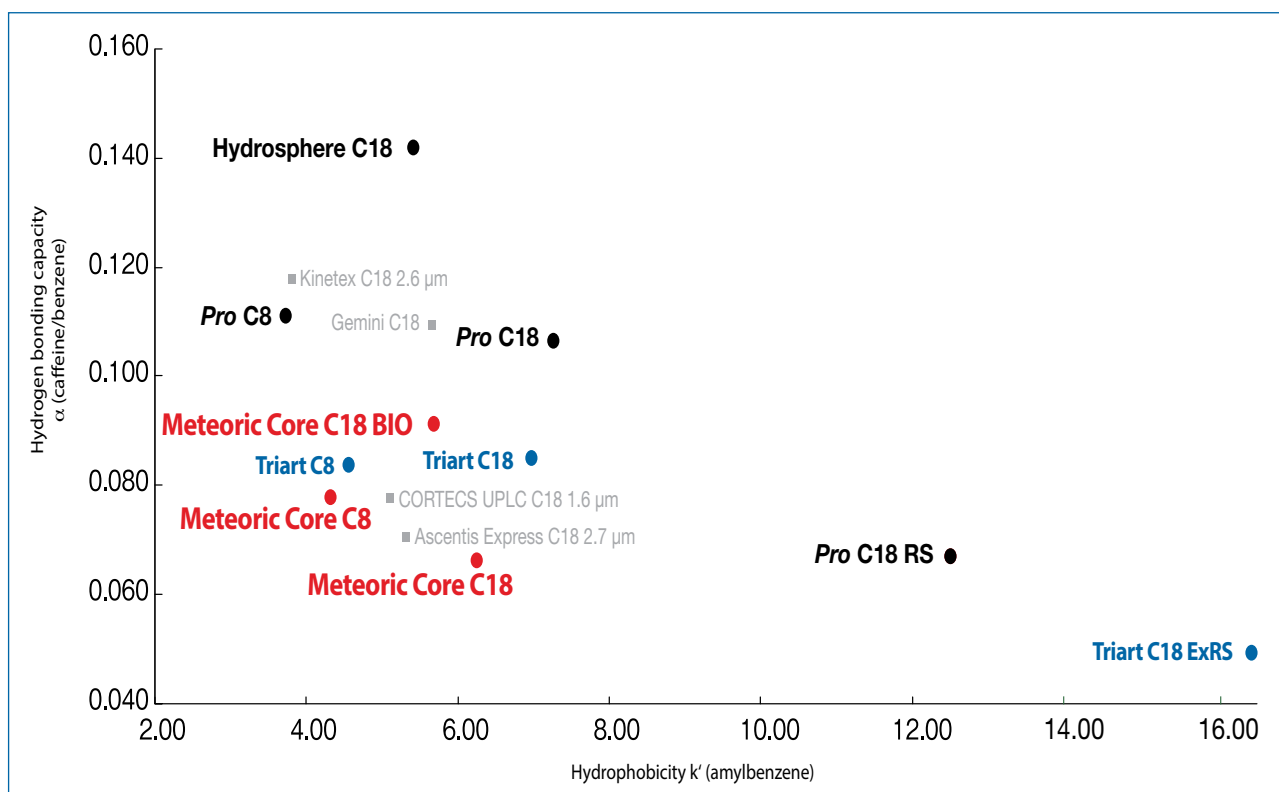

Van Deemter Curves: Correlation between linear velocity and column efficiency

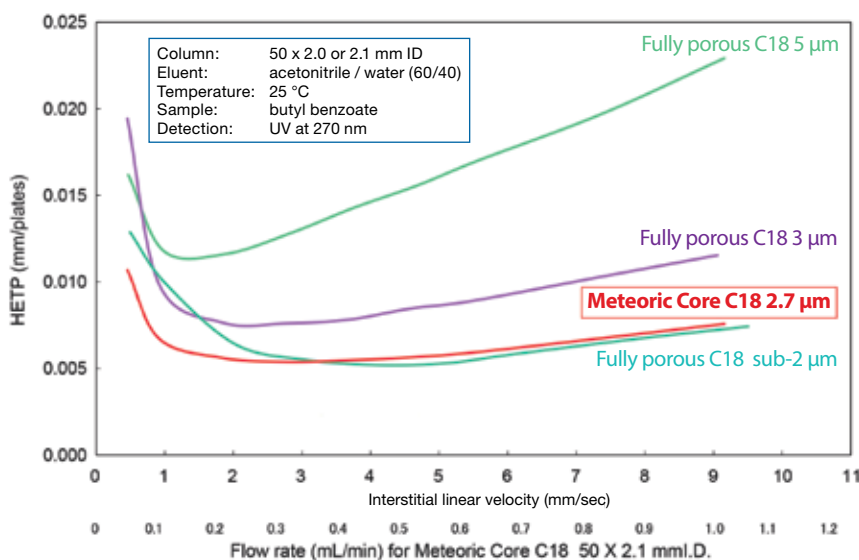

Meteoric Core C18 has high column efficiency which is almost equivalent to sub-2 μm columns over a wide range of flow rates.

Meteoric Core

Applications

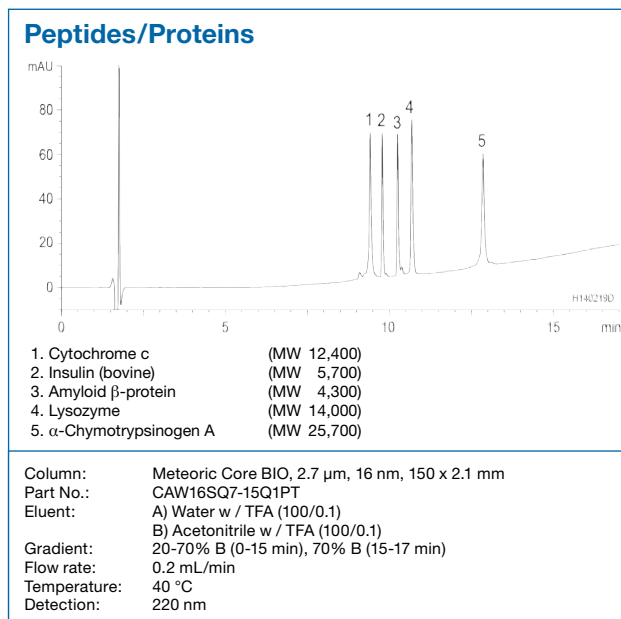
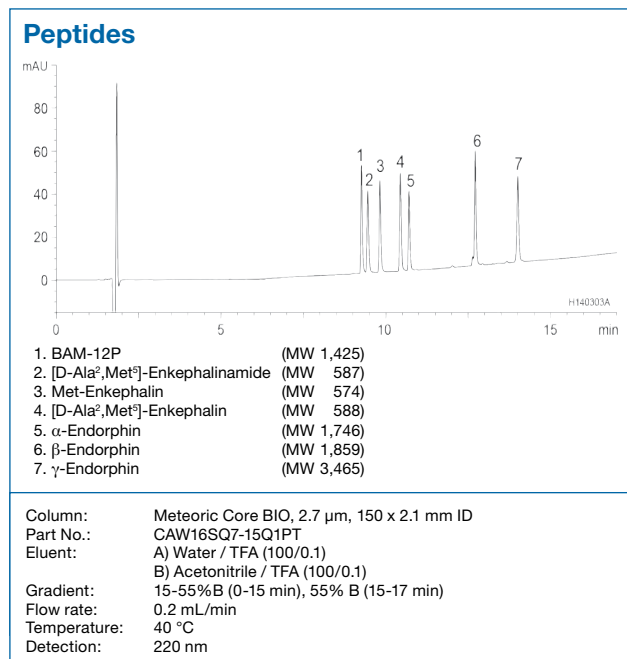

Avastin Peptide Map - Trypsin Digest

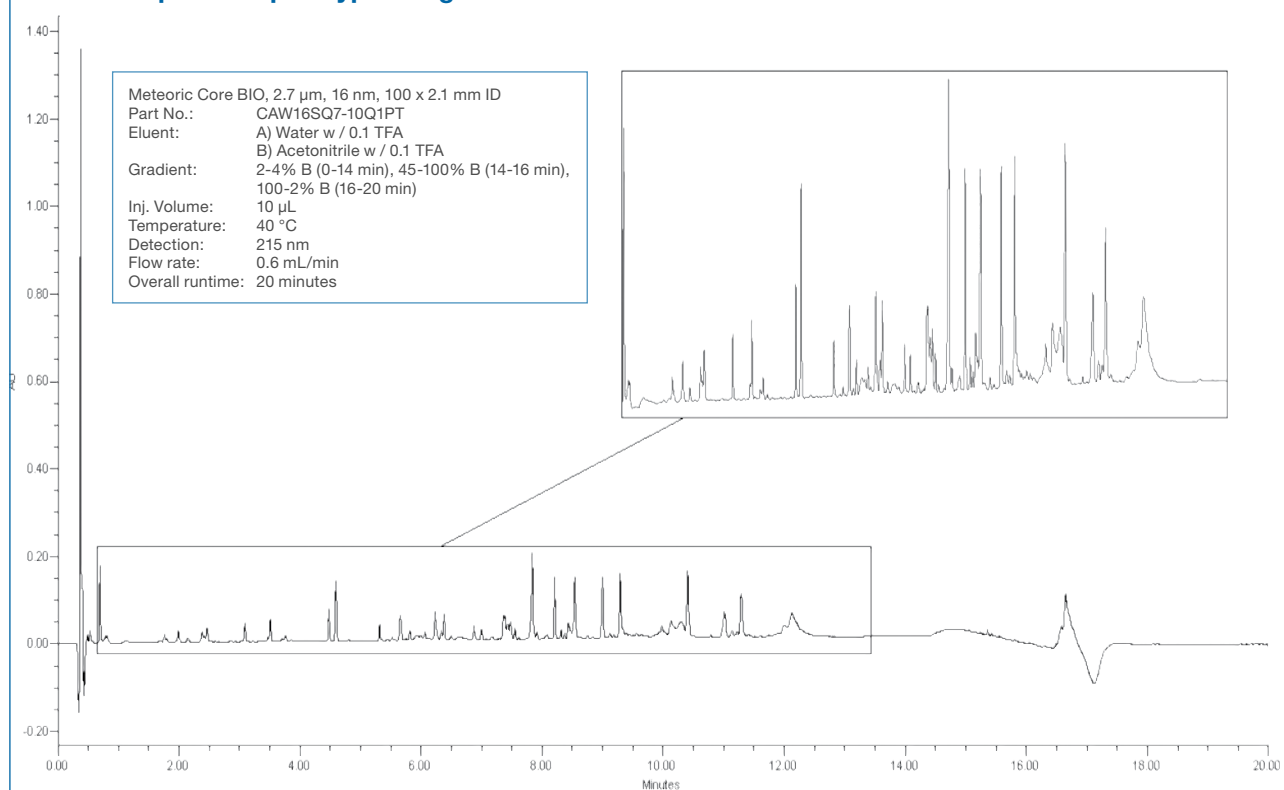

Meteoric Core

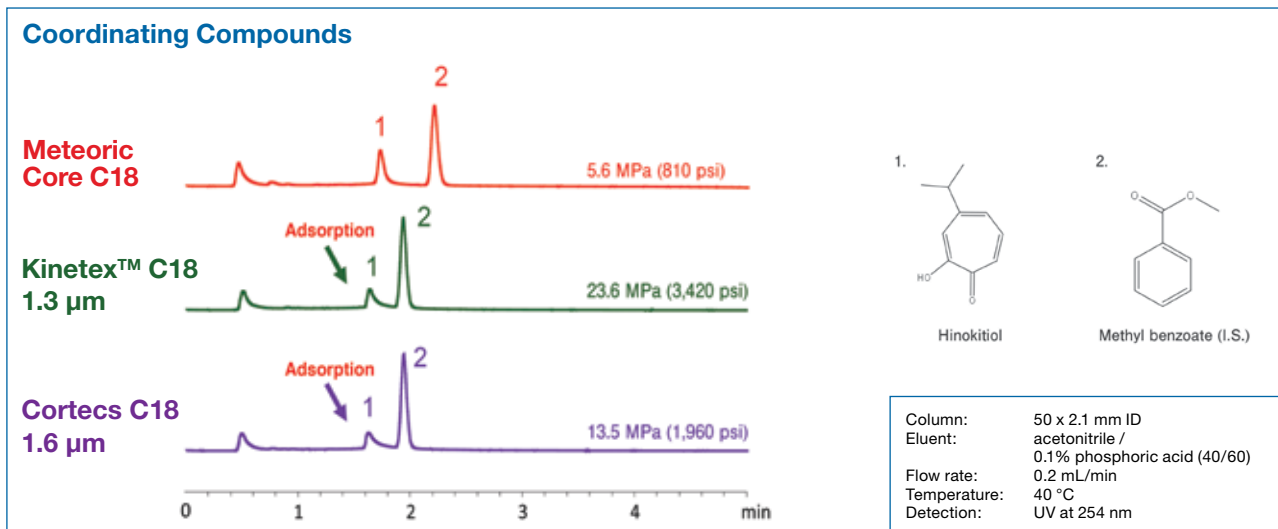

Meteoric Core C18 is able to provide excellent peak shapes for coordinating compounds which are often adsorbed by a column, as a result of a strong interaction with impurities such as trace amounts of metal ions. Meteoric Core is suitable for the quantitative analysis of coordinating compounds.

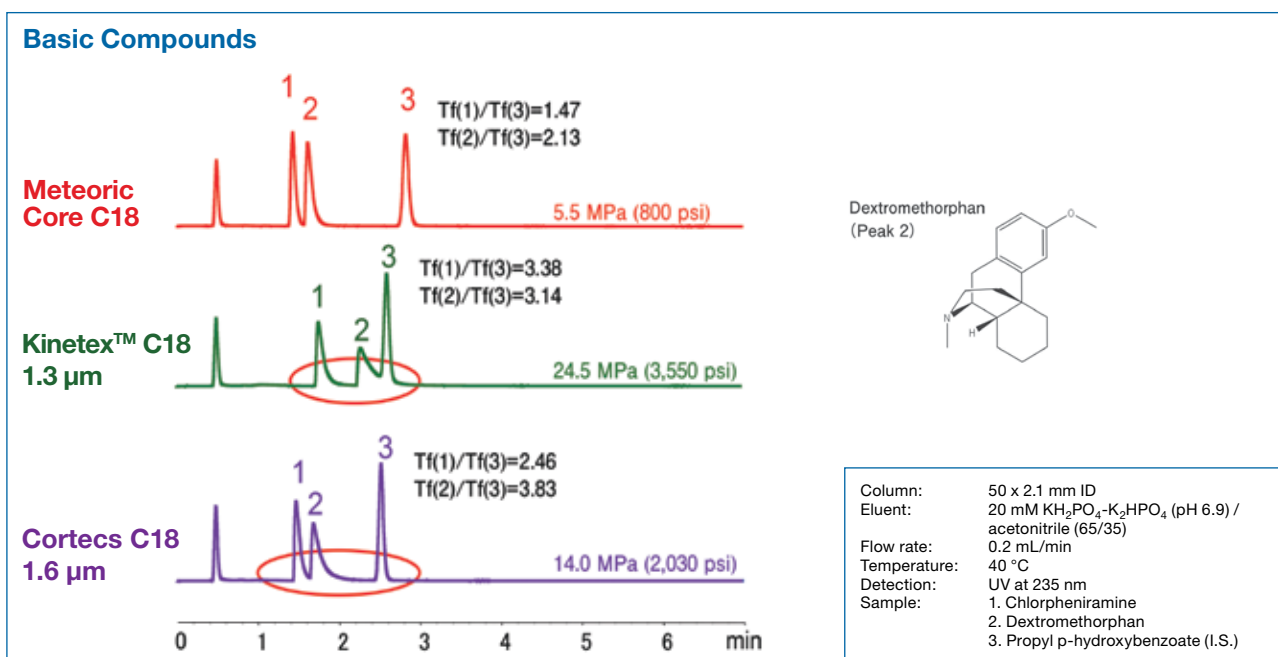

Meteoric Core C18 columns are high resolution columns which provide excellent peak shapes for basic compounds compared to competitors' sub-2 μm core-shell columns. Chromatographers can expect ultrafast analysis of basic compounds with highly quantitative and sensitive analysis when using Meteoric Core C18.

Meteoric Core

Parabens

Ultrafast separation of Parabens: difficult to separate geometric isomers

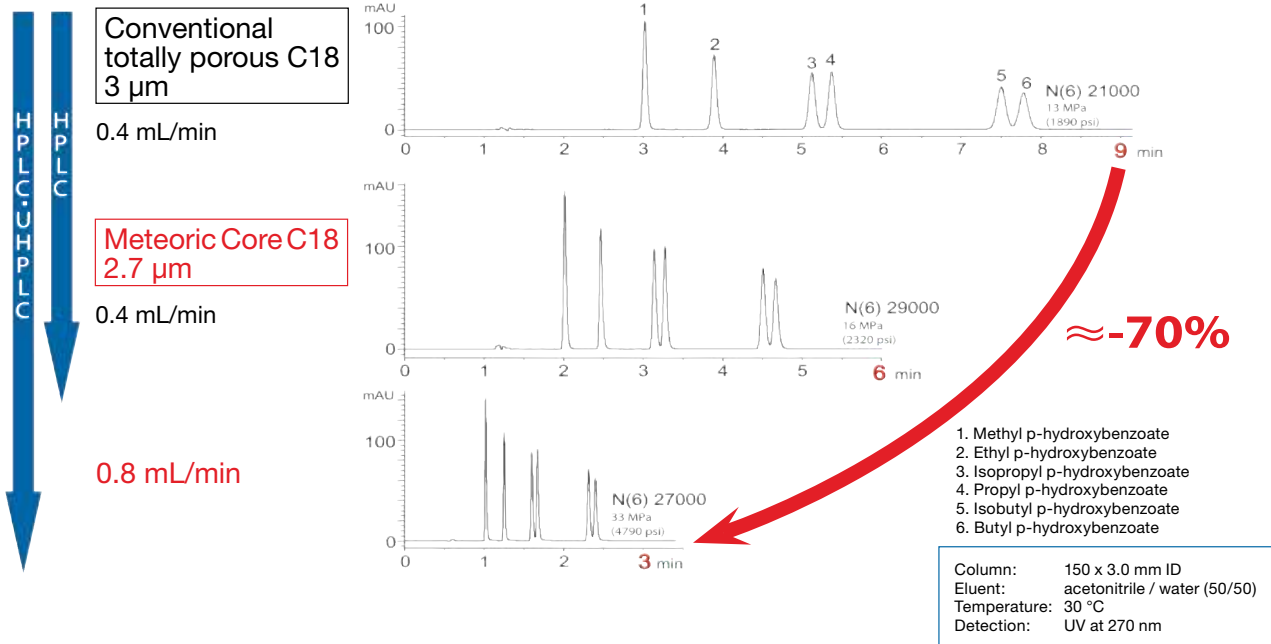

Meteoric Core C18 can shorten the analysis time by two thirds compared to a conventional totally porous C18 column with the same column dimensions and under the same analytical conditions. In addition, it maintains the same efficiency at double the flow rate. This allows a further decrease in analysis time by one third without loss of resolution, and at an operating pressure of less than 5,000 psi.

QC-Data

Correlation between linear velocity and column efficiency

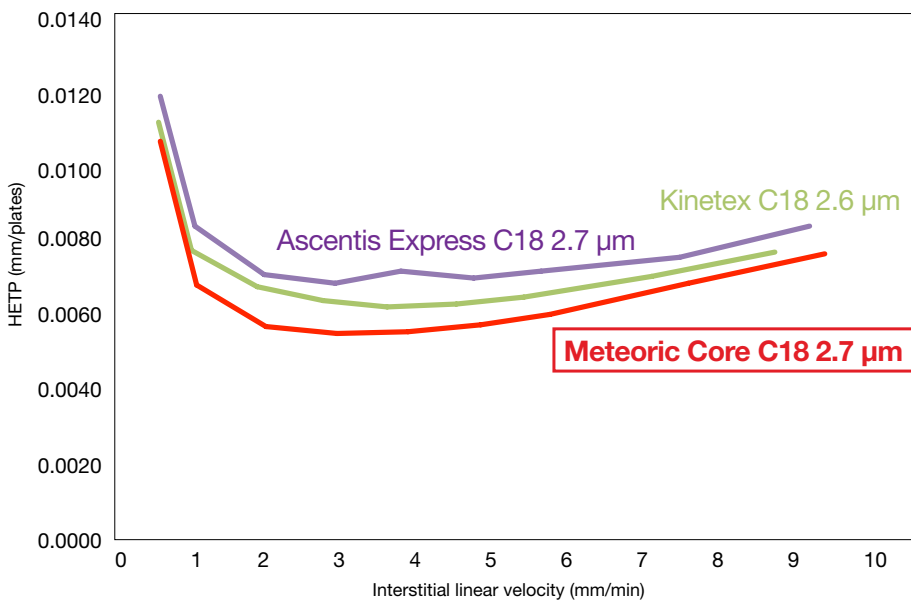

Meteoric Core C18 shows outstanding column efficiencies over a wide flow range.

Column: 50 x 2.0 or 2.1 mm ID
Eluent: acetonitrile / water (60/40)
Temperature: 25 °C
Sample: butyl benzoate
Detection: UV at 270 nm

QC-Data

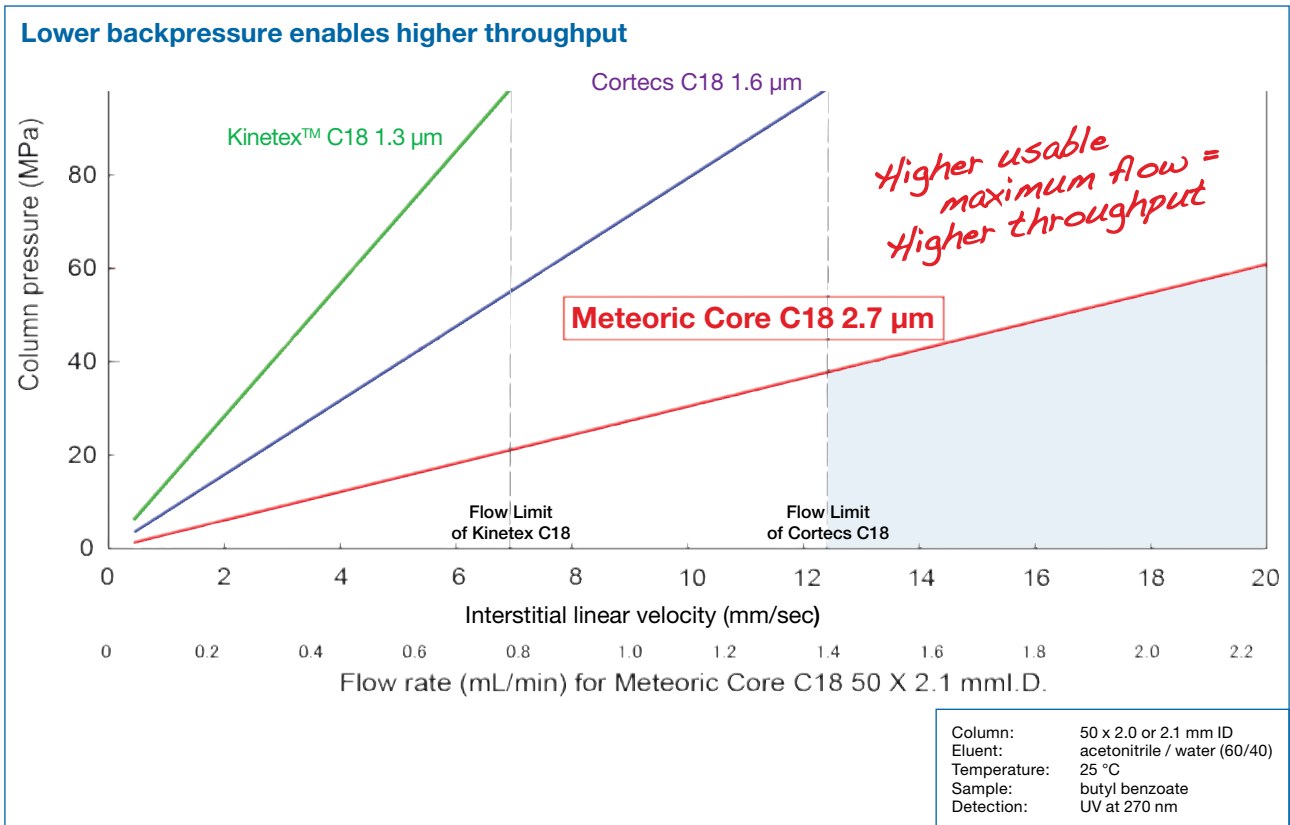

The operating pressure of Meteoric Core is one half to one fifth of sub-2 µm Core-Shell type columns. High throughput analysis using Meteoric Core could be expected even with longer length columns since the usable maximum flow rate is higher than that of competitors' sub-2 µm Core-Shell products.

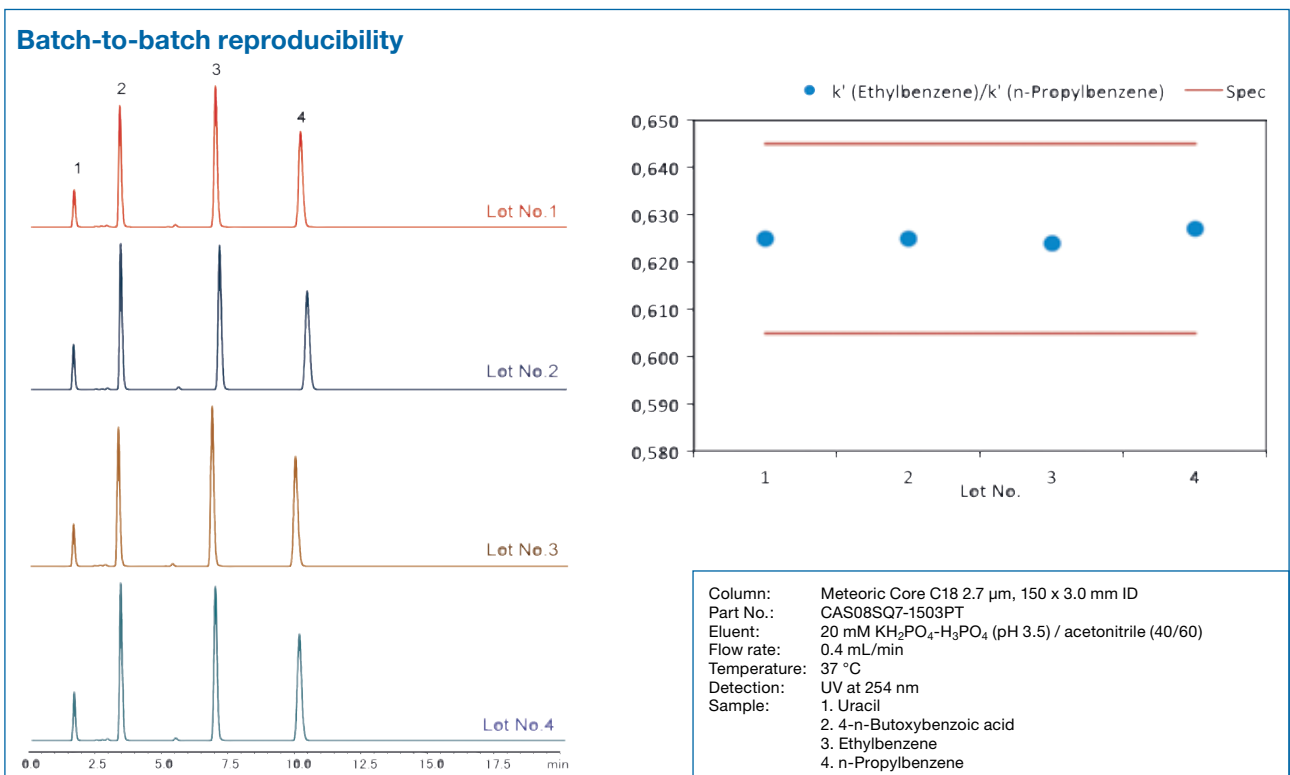

Ordering Information

Meteoric Core

Particle size [μm]	Column size length x ID [mm]	Part number		
		Meteoric Core C18	Meteoric Core C18 BIO	Meteoric Core C8
2.7	30 x 2.1	CAS08SQ7-03Q1PT	CAW16SQ7-03Q1PT	COS08SQ7-03Q1PT
	50 x 2.1	CAS08SQ7-05Q1PT	CAW16SQ7-05Q1PT	COS08SQ7-05Q1PT
	75 x 2.1	CAS08SQ7-L5Q1PT	CAW16SQ7-L5Q1PT	COS08SQ7-L5Q1PT
	100 x 2.1	CAS08SQ7-10Q1PT	CAW16SQ7-10Q1PT	COS08SQ7-10Q1PT
	150 x 2.1	CAS08SQ7-15Q1PT	CAW16SQ7-15Q1PT	COS08SQ7-15Q1PT
	30 x 3.0	CAS08SQ7-0303PT	CAW16SQ7-0303PT	COS08SQ7-0303PT
	50 x 3.0	CAS08SQ7-0503PT	CAW16SQ7-0503PT	COS08SQ7-0503PT
	75 x 3.0	CAS08SQ7-L503PT	CAW16SQ7-L503PT	COS08SQ7-L503PT
	100 x 3.0	CAS08SQ7-1003PT	CAW16SQ7-1003PT	COS08SQ7-1003PT
	150 x 3.0	CAS08SQ7-1503PT	CAW16SQ7-1503PT	COS08SQ7-1503PT
	30 x 4.6	CAS08SQ7-0346PT	CAW16SQ7-0346PT	COS08SQ7-0346PT
	50 x 4.6	CAS08SQ7-0546PT	CAW16SQ7-0546PT	COS08SQ7-0546PT
	75 x 4.6	CAS08SQ7-L546PT	CAW16SQ7-L546PT	COS08SQ7-L546PT
	100 x 4.6	CAS08SQ7-1046PT	CAW16SQ7-1046PT	COS08SQ7-1046PT
	150 x 4.6	CAS08SQ7-1546PT	CAW16SQ7-1546PT	COS08SQ7-1546PT

Column end fitting and column connections

Tubing and connector

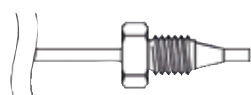

Column

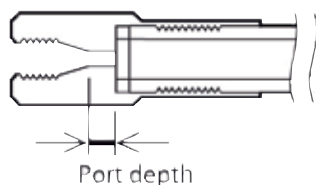

Port depth

The end of the product number	Port depth	Style of endfitting
PT	2 mm	UPLC compatible (Parker) style

UPLC is a registered trademark of Waters Corporation.

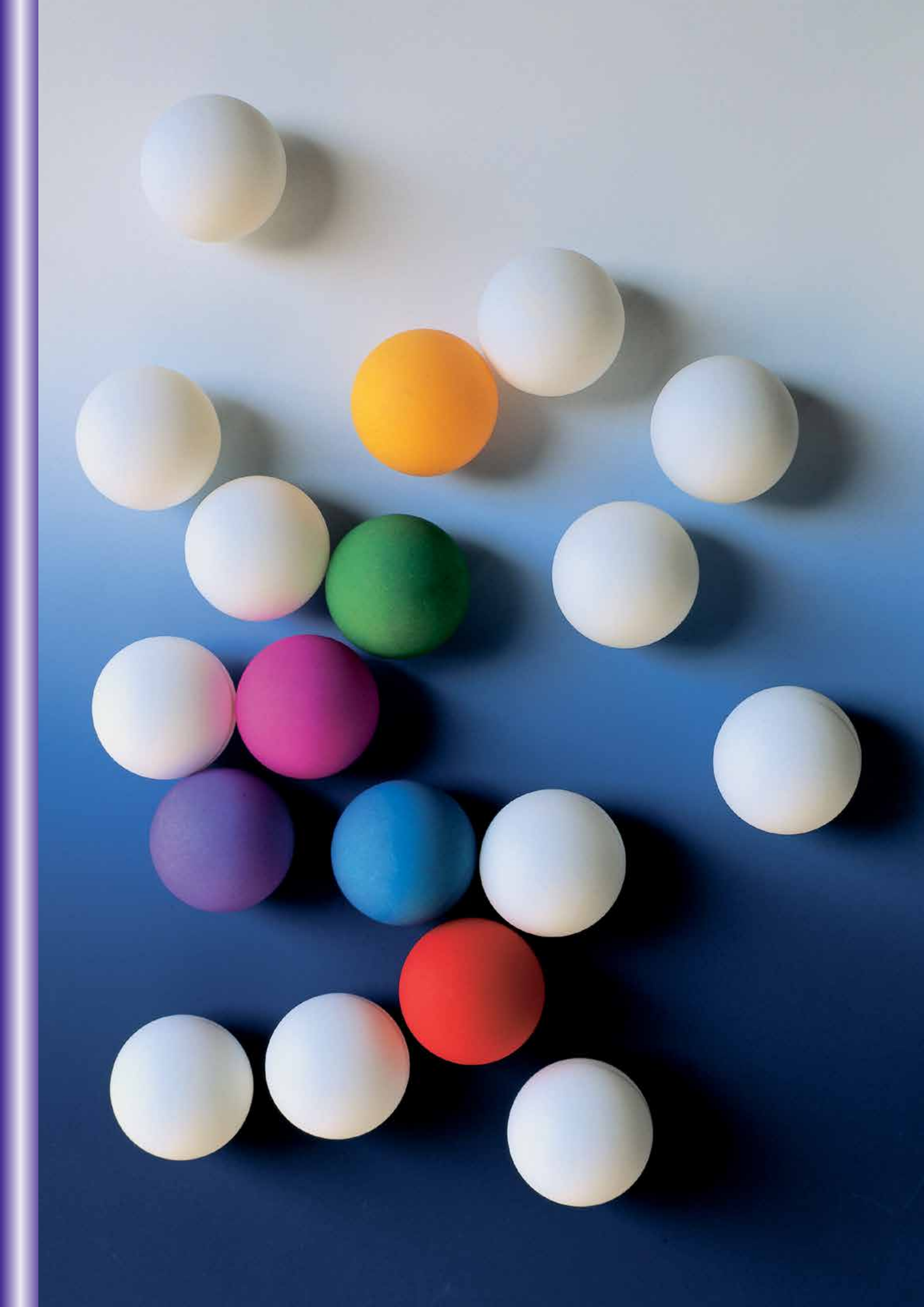

YMC ProFamily

Contents

YMC-UltraHT <i>Pro</i> C18 and Hydrosphere C18	106-113
General	114-121
YMC-Pack <i>Pro</i> C18	122-123
YMC-Pack <i>Pro</i> C8	124-125
YMC-Pack <i>Pro</i> C4	126-127
YMC-Pack <i>Pro</i> C18 RS	128-131
Hydrosphere C18.....	132-133
Ordering Information.....	134-135

Introduction

HPLC Columns for Ultra Fast LC

Nowadays, especially in the pharmaceutical industry, the need for Ultra Fast LC and Rapid Resolution is still growing due to the continuous demand for high throughput analysis in research & development and quality control.

Specifications for YMC-UltraHT columns have been designed to provide powerful chromatographic improvements, in terms of velocity and resolution, even with conventional HPLC equipment. Since YMC-UltraHT columns provides a substantially lower pressure drop than most competitive 2 µm or sub-2 µm media, high flow rates can be achieved without generating excessive back pressure and without the need for specialised equipment.

For effective high throughput separations, YMC offers a wide range of high performance HPLC columns which allow Ultra Fast analytical HPLC with conventional equipment. Due to the down-scalability of the majority of YMC's stationary phases, the time needed for a single analysis can be reduced to less than 60 seconds, depending on the sample conditions.

YMC ProFamily

One of the main challenges in RP-HPLC is the quantitation of ionisable compounds including drugs, degradation products, etc. For this purpose symmetrical, sharp peaks are required to provide highest resolution and reliable integration. The stationary phases of the YMC ProFamily fulfil these demands making them an excellent choice for the pharmaceutical and biotechnology industries. This product line consists of the three C18-phases: YMC-Pack *Pro* C18 RS (with high carbon load [22%]), YMC-Pack *Pro* C18 and Hydrosphere C18 ("AQ-type") together with the C8- and C4-phases: YMC-Pack *Pro* C8 and YMC-Pack *Pro* C4.

Ultra Fast LC Columns

- YMC Pack *ProFamily* chemistries, based on ultra high purity silica, provide excellent resolution for a wide range of analytes
- YMC-UltraHT LC columns provide considerable time saving without resort to ultra high pressures
- YMC-UltraHT LC columns achieve ultra fast separations even with conventional HPLC equipment
- fully up- and down-scalable selectivity



Specifications	YMC-UltraHT <i>Pro</i> C18	YMC-UltraHT Hydrosphere C18
Particle size / μm	2	2
Pore size / nm	12	12
Surface area / m^2g^{-1}	330	330
Carbon content / %	16	12
Recommended pH range	2.0 - 8.0	2.0 - 8.0

General

Since the introduction of the *ProFamily* series of phases, YMC-Pack *Pro* C18 has proved to be one of the first choices for a wide range of HPLC applications in pharmaceutical and biotechnological research and production, where efficiency and reliability are a major demand.

In many cases, the separation of highly polar compounds requires highly aqueous mobile phase conditions to achieve sufficient retention on the stationary phase. Conventional reversed phase selectivities do not give reproducible results under these conditions due to mainly collapse of the C18 chains. Therefore, YMC developed Hydrosphere C18 in order to overcome the loss in retention. Now, this outstanding chromatographic behaviour has been transferred to YMC-UltraHT Hydrosphere C18.

YMC-Pack *Pro* C18 is a well-established C18 silica-based column, which provides a medium balance of hydrogen-bonding capacity and hydrophobicity, as shown below. Conversely, Hydrosphere C18 is optimal selectivity for the separation of highly polar compounds.

Ultra Fast LC Columns

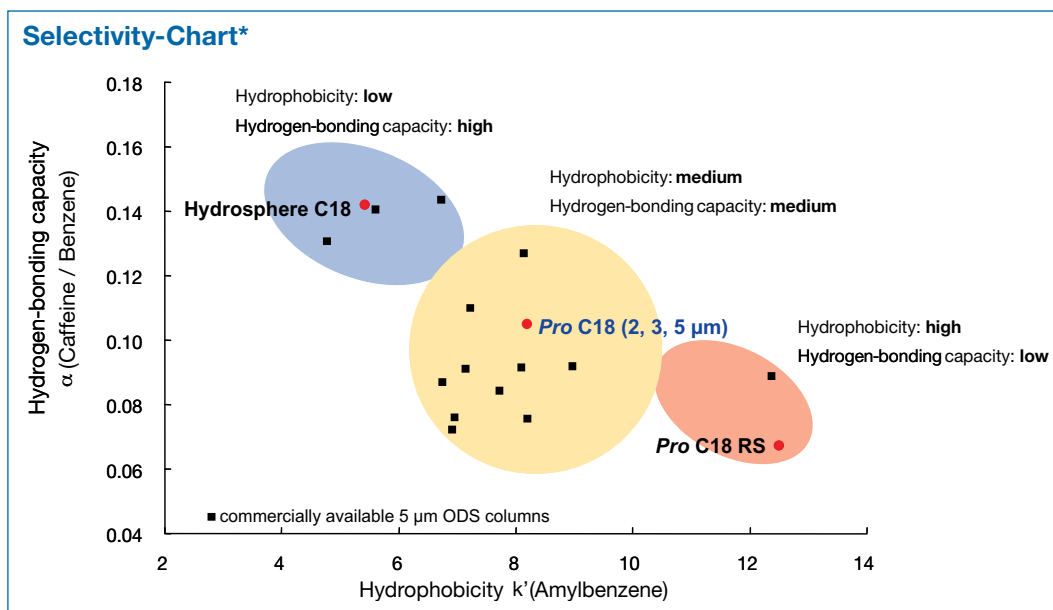

Why smaller particles?

Ever since in the beginning of HPLC, more-demanding analytical problems have required a progressive improvement in separation efficiency. The challenges include ever more complex analytes and the reduction in analysis times to keep up with the increasing numbers of samples. In addition to reducing the column dimensions and increasing flow rates, the implementation of small particles is a powerful tool to increase efficiency.

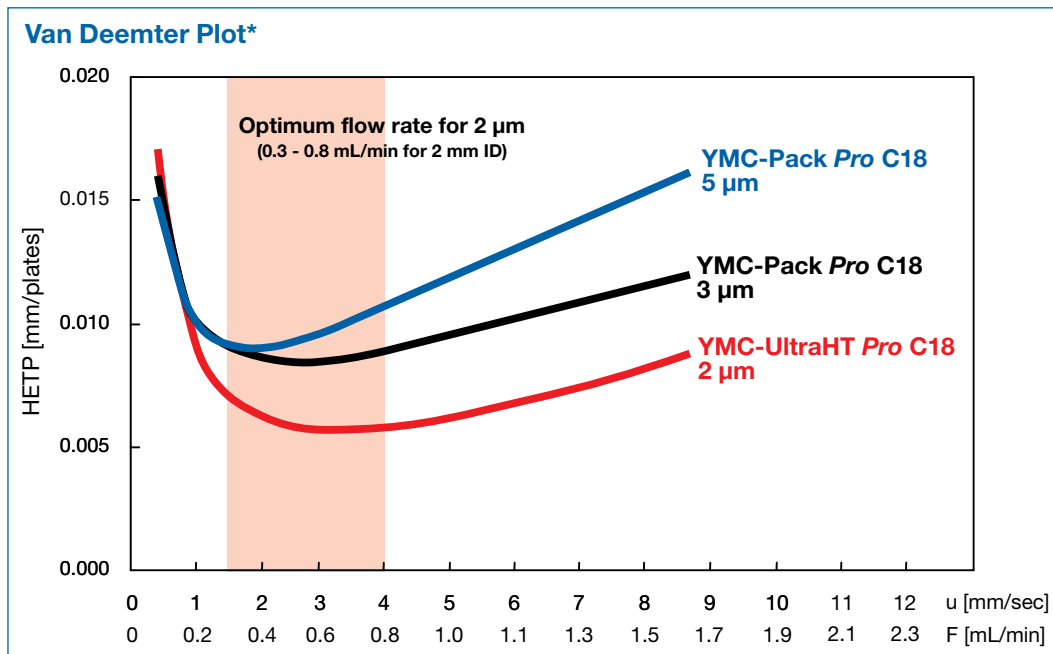

The van Deemter equation describes the “Height Equivalent of the Theoretical Plate” (HETP) as a function of the linear velocity (u) by

$$H = A + B/u + C \cdot u$$

where A, B and C are constants and u is the mobile phase linear velocity measured in mm/sec.

The resulting van Deemter plots show the reduction of HETP when using smaller particle sizes of YMC-Pack Pro C18 with an additional shift of the minimum value to higher flow rates.

Features of Packing Material

When starting to focus on Ultra Fast LC through the use of small particles, very high back pressures have to be considered and a balance sought. The extensive experience in silica production enables YMC to provide small particles with an extremely narrow particle size distribution which results in low back pressures.

YMC's UltraHT Pro C18 columns offer outstanding efficiency for Fast LC without exhibiting extremely high back pressure values which can be obtained with sub-2 µm particles from other manufacturers. Therefore YMC's UltraHT Pro C18 may not require dedicated HPLC equipment for providing outstanding column performances.

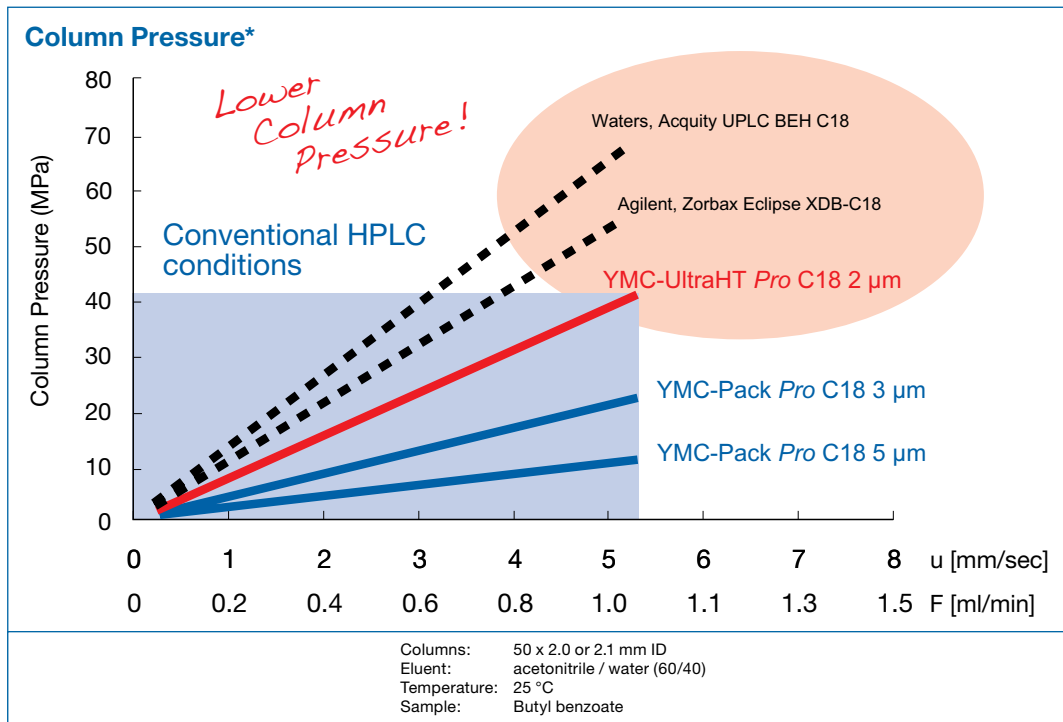

The introduction of YMC-UltraHT Pro C18 2 µm allows easy downscaling of existing methods which use YMC-Pack Pro C18 3 µm and 5 µm.

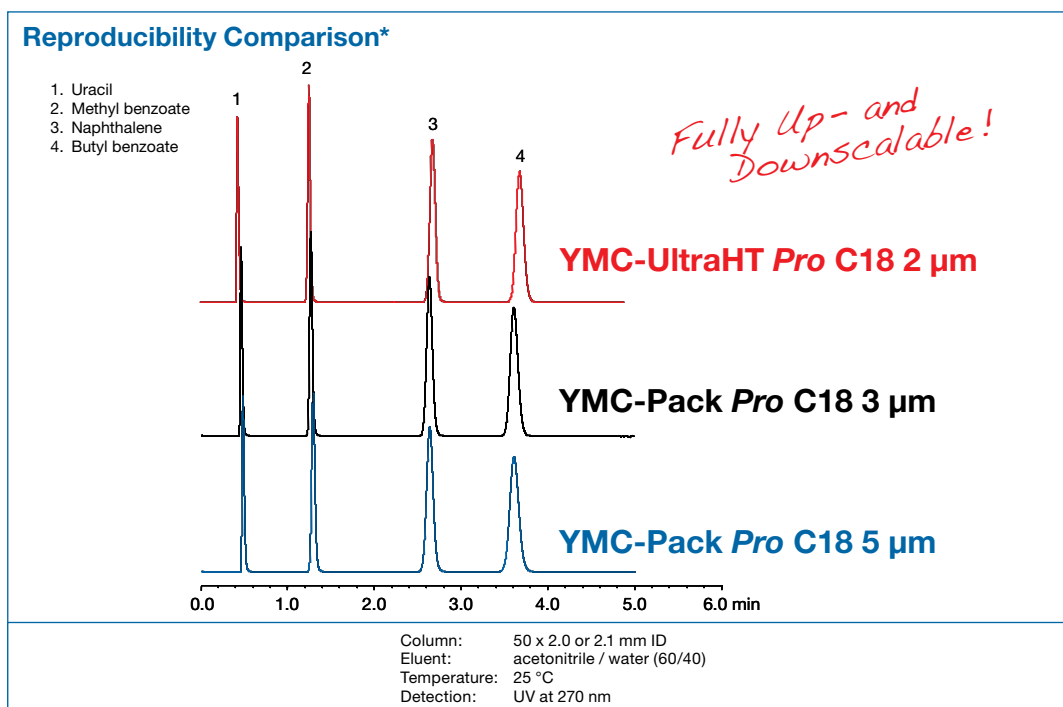

Features of Packing Material

The graph below shows the dependency of “Height Equivalent of the Theoretical Plate” (HETP) and the linear velocity in the presence of different organic solvents. When methanol is used, the optimum HETP is achieved within a different range of velocity compared to when acetonitrile is used due to their different viscosities. Therefore the optimum range of flow rate changes with the organic solvent.

The maximum resolution is obtained by optimising flow rate, temperature, and organic solvent in order to achieve the optimum back pressure.

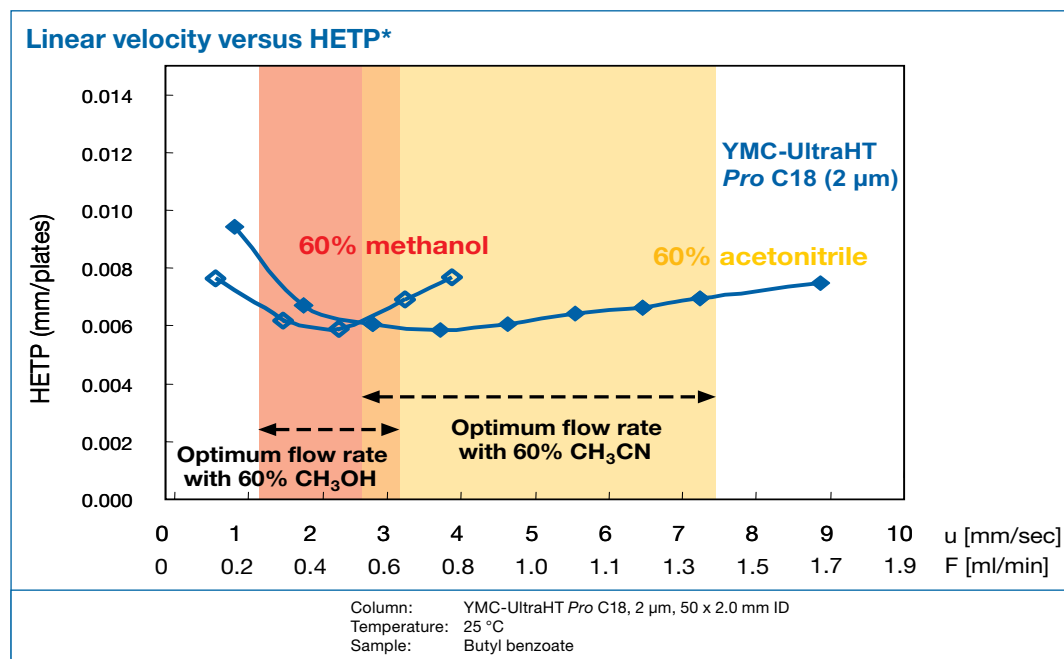

Since YMC-UltraHT columns provide substantially lower pressure drop than most competitive 2 µm or sub-2 µm media, high flow rates can be achieved without generating excessive back pressure and without the need for specialised equipment. Nevertheless, 3 mm ID columns are less affected by the diffusion volume than 2 mm ID columns. Therefore, it is necessary to reduce the system “dead” volume in order to obtain outstanding chromatographic performances with 2 mm ID columns.

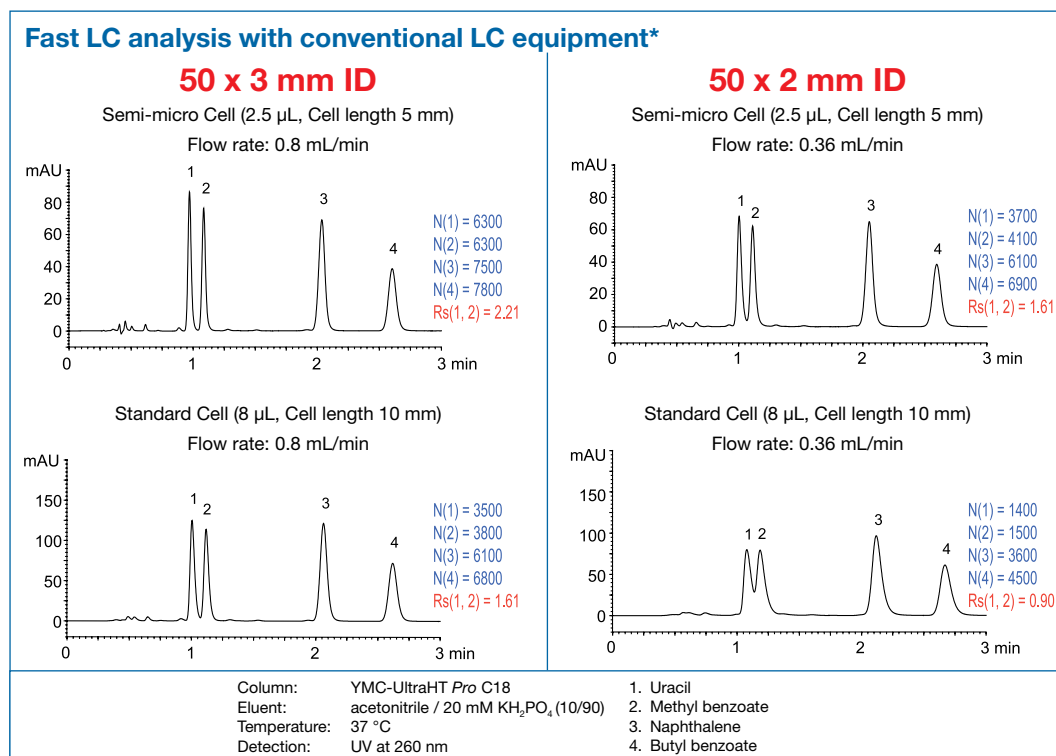

Downscale of Methods

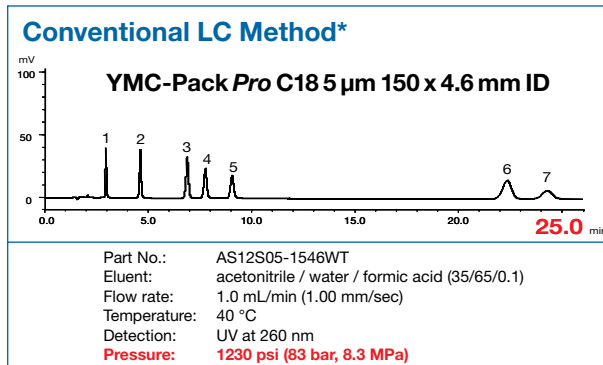

Due to the production processes used to manufacture YMC-Pack ProFamily, methods can be easily downscaled with unchanged selectivity.

As the examples shown demonstrate, conventional HPLC methods can be transferred easily to Ultra Fast LC methods by choosing YMC-UltraHT columns to gain efficiency and significantly reduce analysis time.

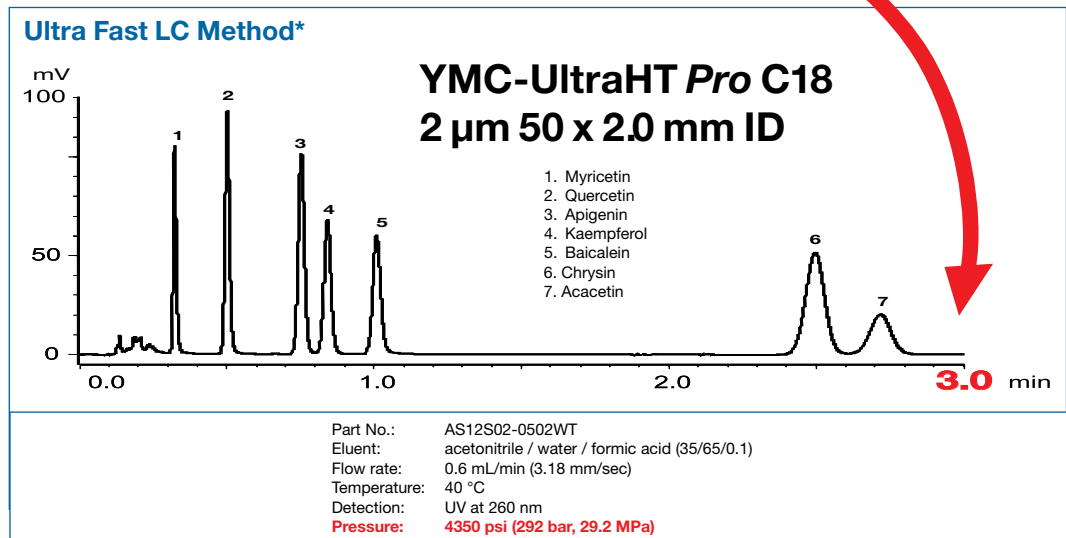

The application of HPLC to biologically relevant separations is an existing and rapidly growing field. YMC-UltraHT Pro C18 provides outstanding chromatographic performance, which is more than capable of meeting the challenge of peptide mapping, where a large number of peptide fragments are generated from enzymatic digestion.

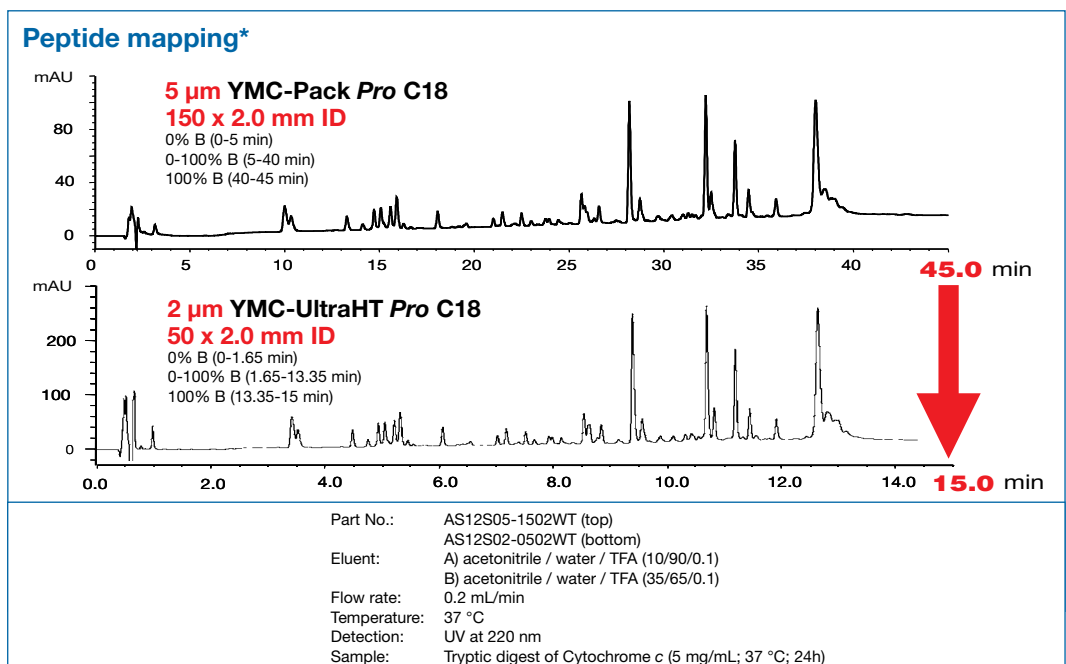

Downscale of Methods

Method transfer from conventional LC to Ultra Fast LC*

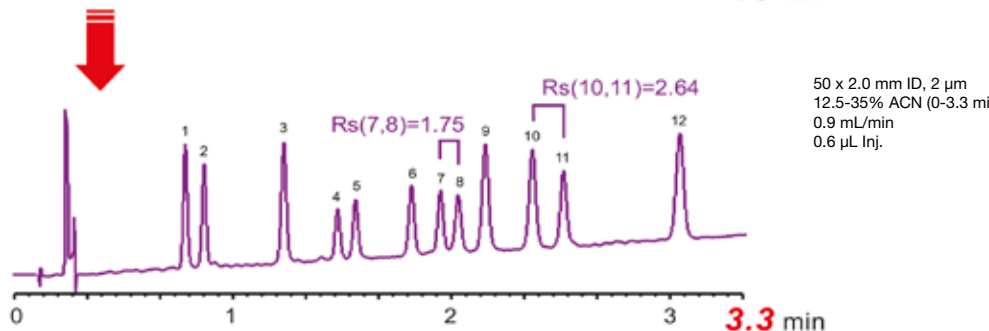
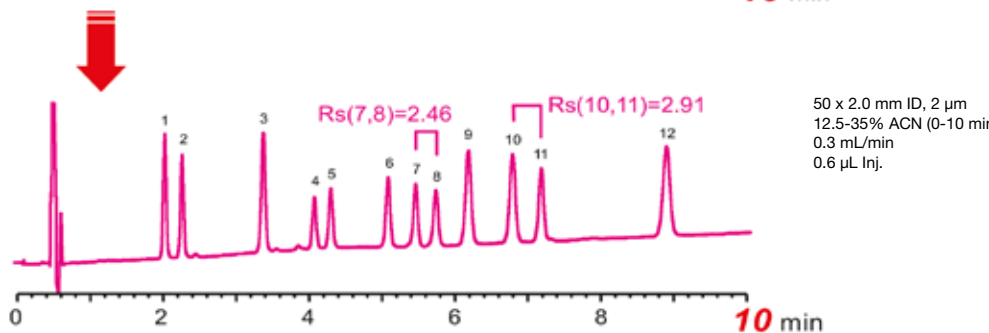
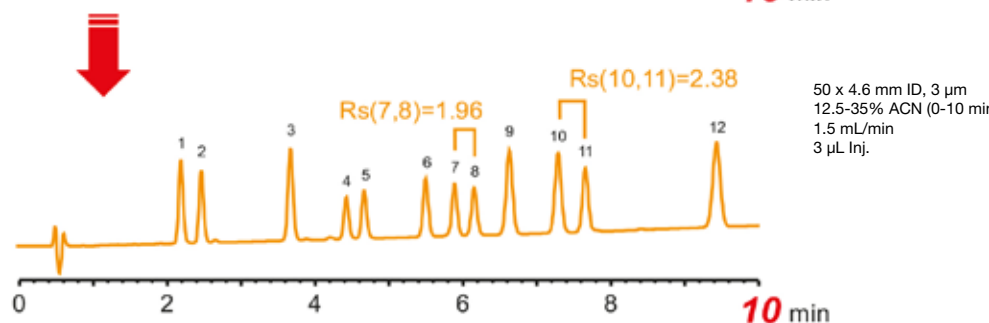
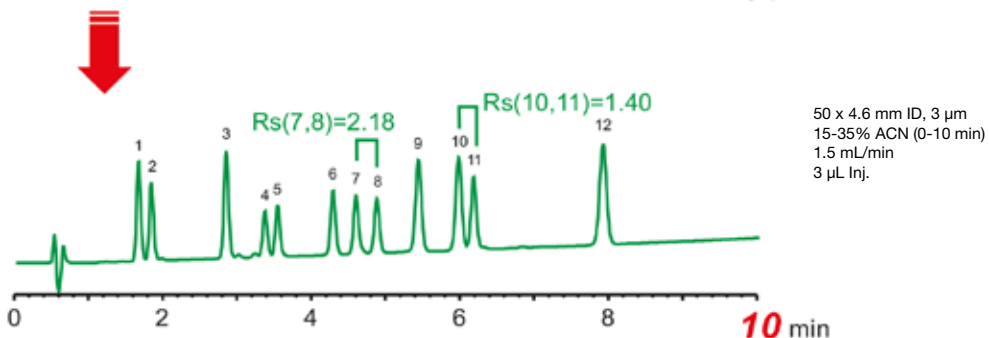
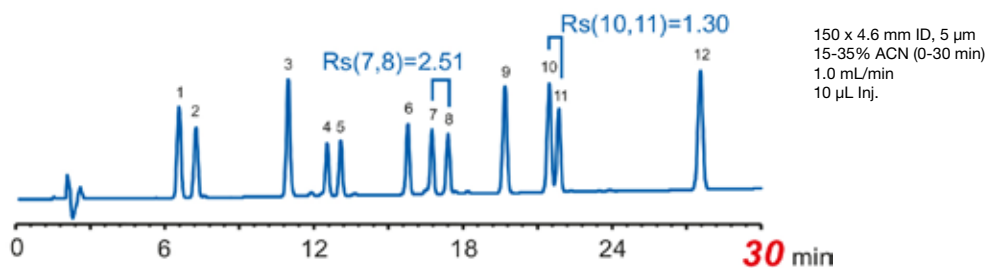

Columns: Hydrosphere C18
Eluent: A: water / acetic acid (100/3)
B: acetonitrile / acetic acid (100/3)
Temperature: 35 °C
Detection: UV at 254 nm

- | | |
|-------------------------|-------------------------|
| 1. Daidzin | 7. 6'-O-Acetylglycitin |
| 2. Glycitin | 8. 6'-O-Malonylgenistin |
| 3. Genistin | 9. Daidzein |
| 4. 6'-O-Malonyldaidzin | 10. Glycitein |
| 5. 6'-O-Malonylglycitin | 11. 6'-O-Acetylgenistin |
| 6. 6'-O-Acetyldaidzin | 12. Genistein |

* Application data by courtesy YMC Co., Ltd.

Downscale of Methods

Why not take the pressure out of Fast LC!

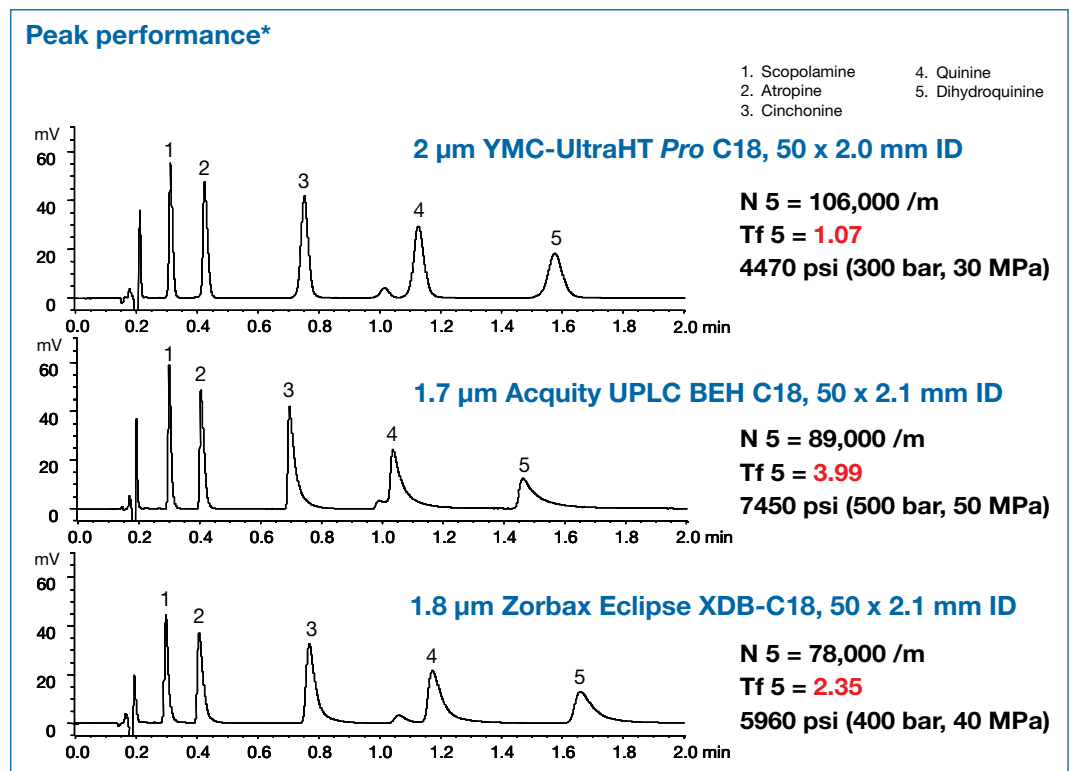

With YMC-UltraHT Pro C18 you have all the efficiency you need to develop your Fast LC methods with none of the pressure or heat some would have you believe is essential!

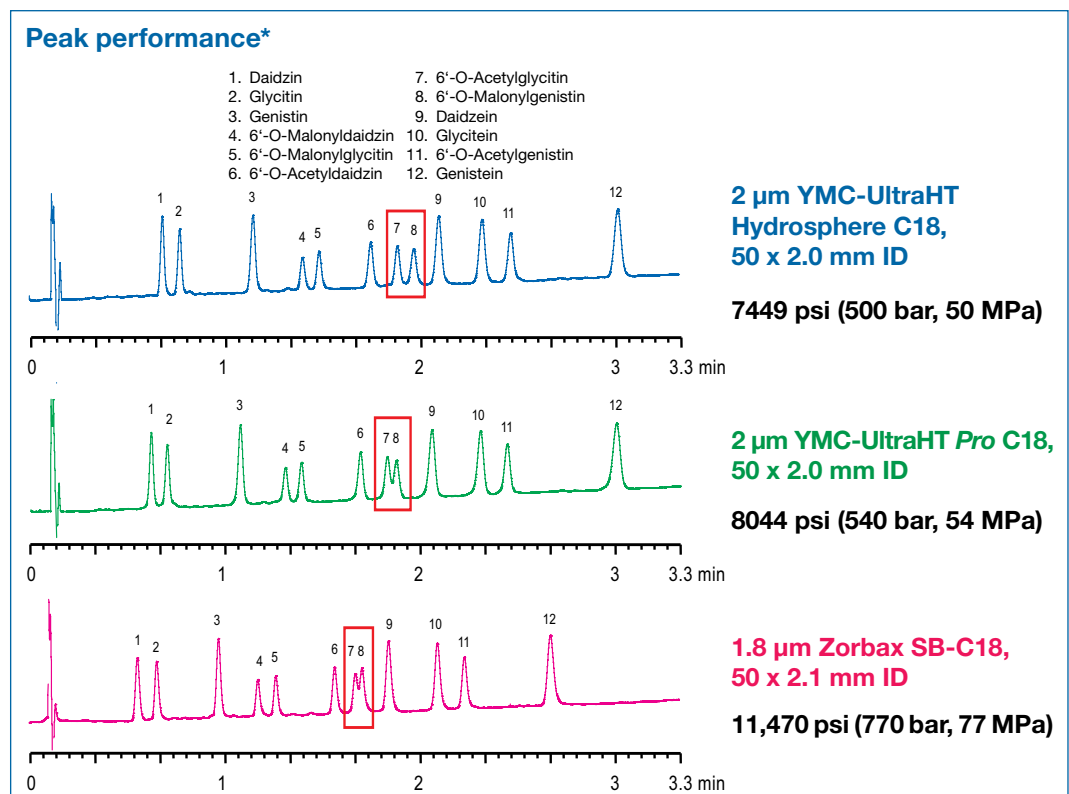

Downscale of Methods

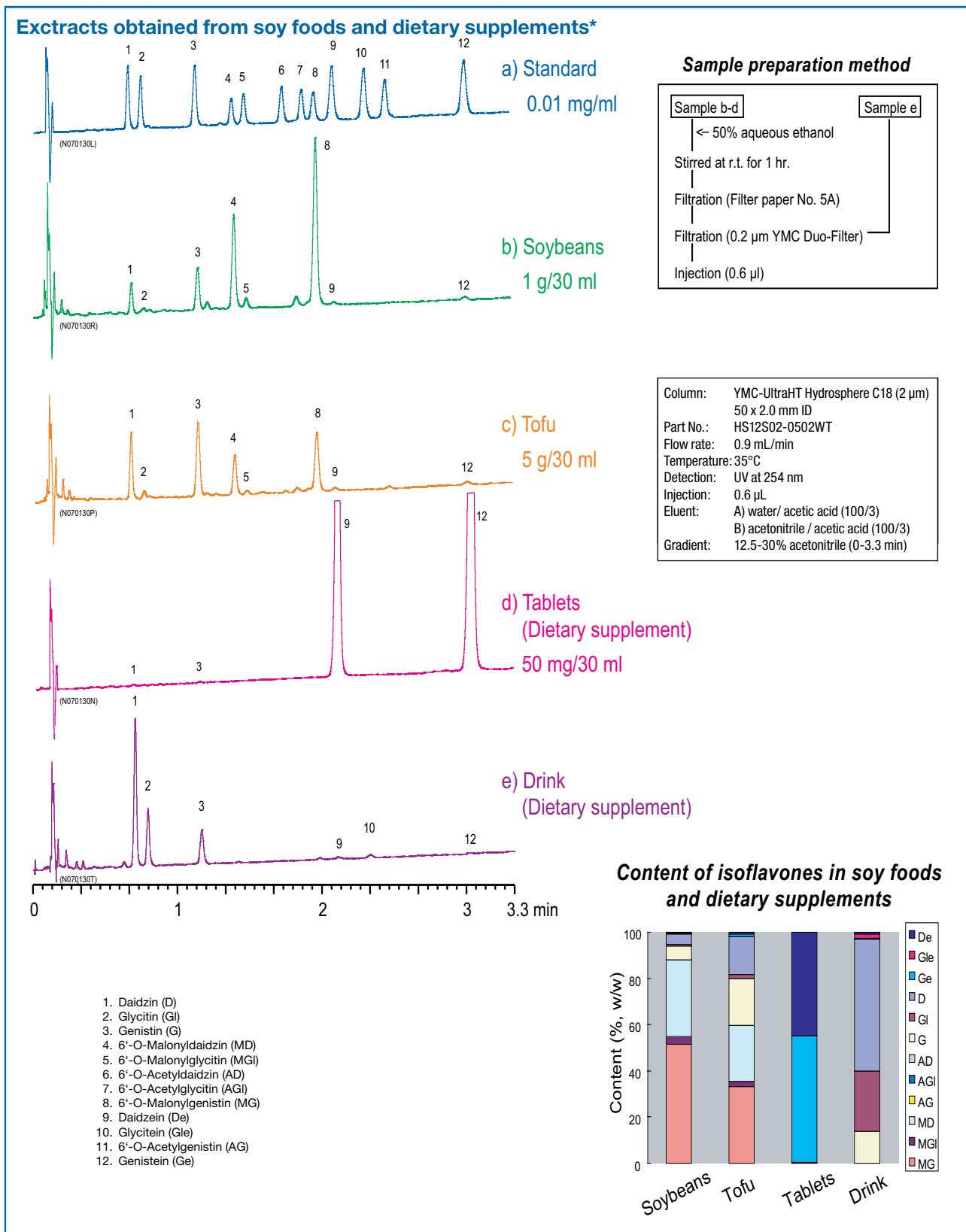

* Application data by courtesy YMC Co., Ltd.

YMC ProFamily

- YMC-Pack ProFamily based on ultra high purity silica
- Hydrosphere C18 for stability in aqueous mobile phases
- every packed column supplied with:
 - lot certificate
 - test chromatogram



	Pro C18	Pro C8	Pro C4	Pro C18 RS	Hydrosphere C18
Particle size / μm	2; 3; 5	3; 5	3; 5	3; 5	2; 3; 5
Pore size / nm	12	12	12	8	12
Surface area / m^2g^{-1}	330	330	330	510	330
Carbon content / %	16	10	7	22	12
pH range	2.0 - 8.0	2.0 - 7.5	2.0 - 7.5	1.0 - 10.0	2.0 - 8.0
Metal content	(Randomly selected lots)				
Al / ppm	0.3	0.2	0.6	0.3	0.7
Fe / ppm	2.8	2.5	2.9	0.1	1.2
Na / ppm	0.3	1.4	1.0	1.3	0.7
Ti / ppm	0.1	0.1	0.1	0.1	0.1

Properties

Strict quality control is enforced during the manufacturing of the underlying silica, bonding of the stationary phase, endcapping and column packing operations to supply high performance columns of high reproducible quality over a long period of time.

Lot-to-lot reproducibility of YMC-Pack Pro C18

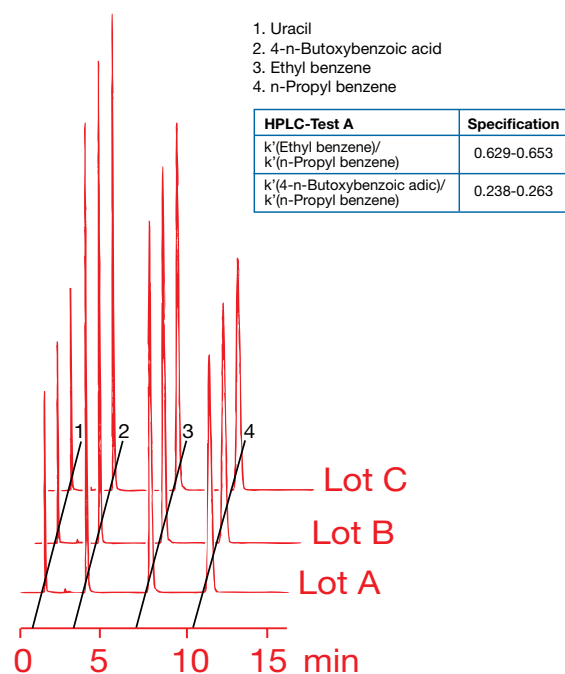

HPLC Test A

Column: 150 x 4.6 mm ID
 Eluent: 20 mM KH_2PO_4 - H_3PO_4 (pH3.5) / acetonitrile (40/60,v/v)
 Flow rate: 1.0 mL/min
 Detection: UV at 254nm
 Temperature: 37 °C

YMC ProFamily

Underlying silica gel support

The physical properties of silica gel have a great effect on the selectivity and performance of the bonded packing. For the purpose of supplying columns of stable quality, the physical properties of silica gel used for packing such as particle size, pore size, specific surface area, pore volume and amount of metal contamination have to be strictly controlled.

Physical properties (Pro C18, 5 μm, 12 nm)

Silica Support Material (5 μm, 12 nm)

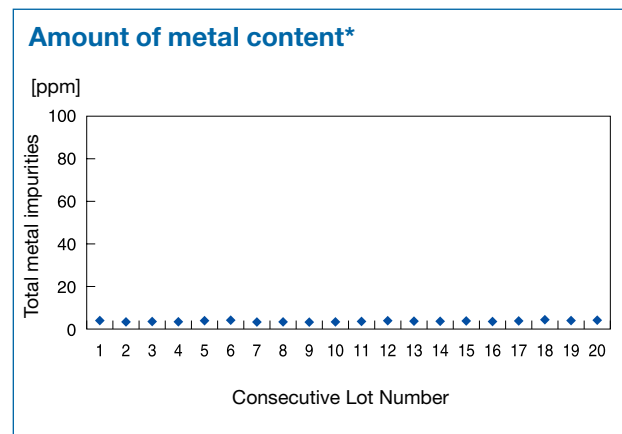
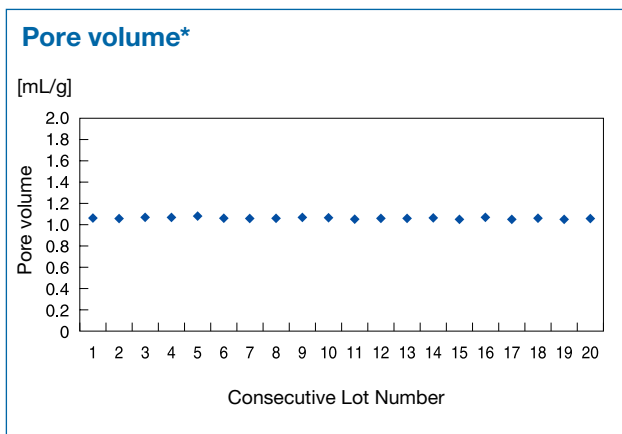
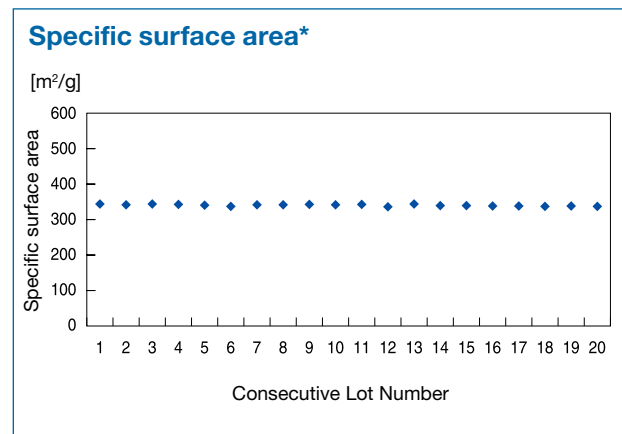
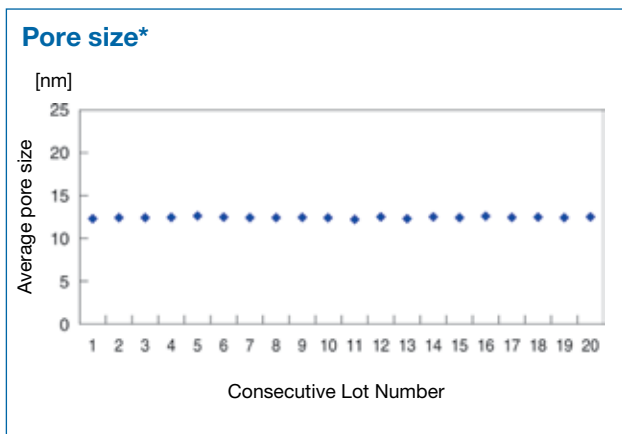
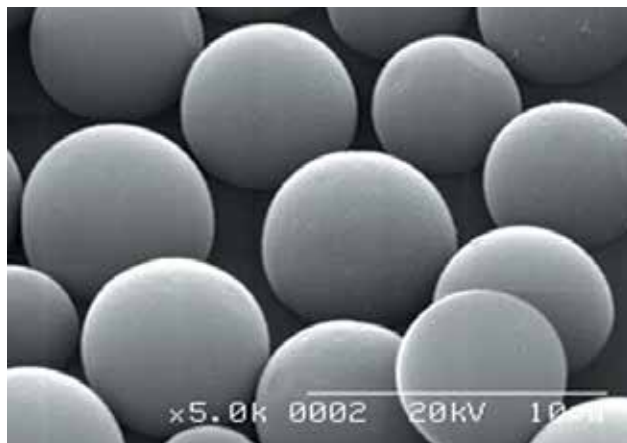
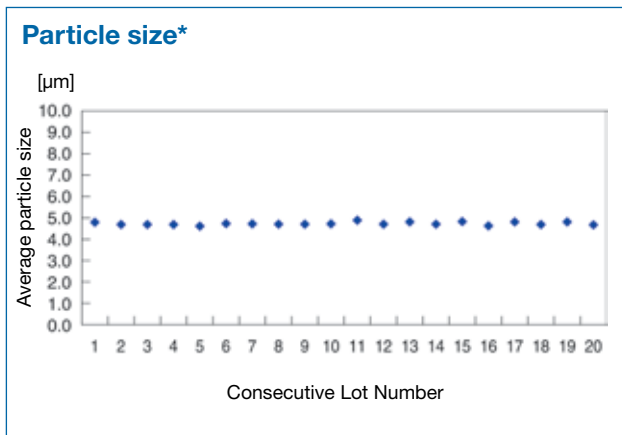

YMC ProFamily

Packing material

Excellent reproducibility of the Pro C18 is shown not only in the separation of hydrophobic compounds but also in that of hydrophilic, basic, and acidic compounds.

Pro C18 5 μ m, Reproducibility between batches

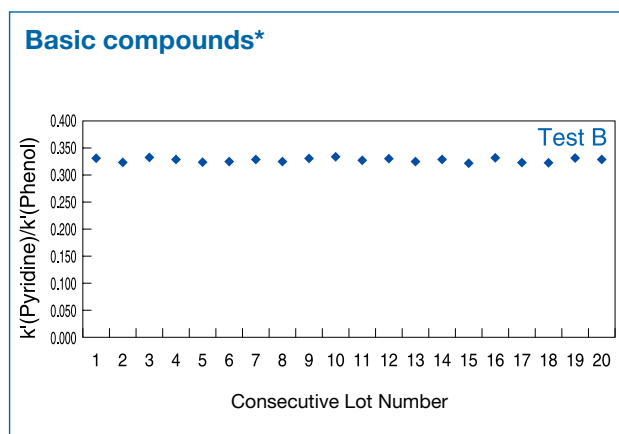
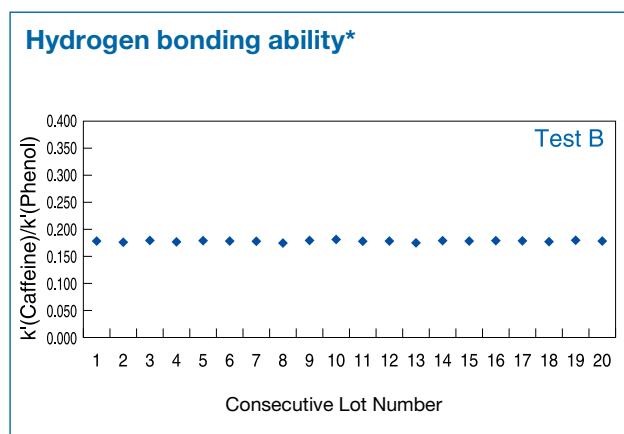
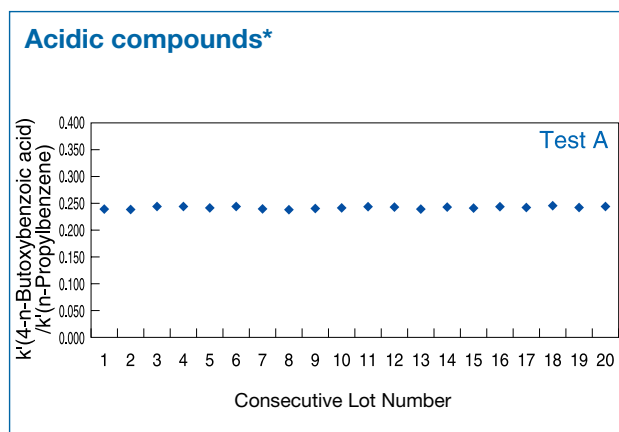
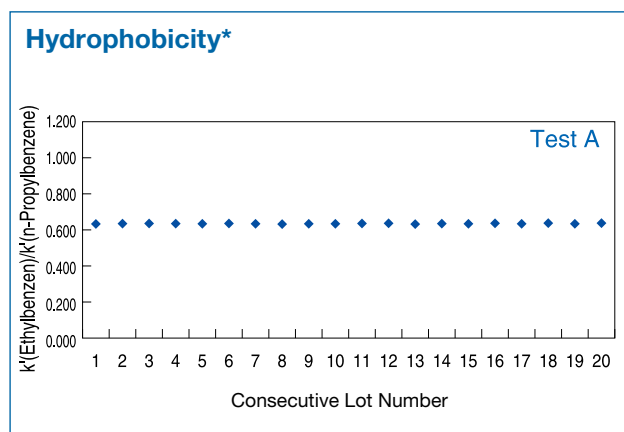
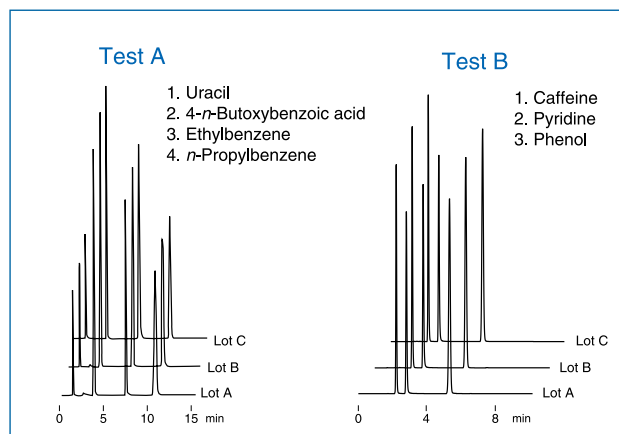
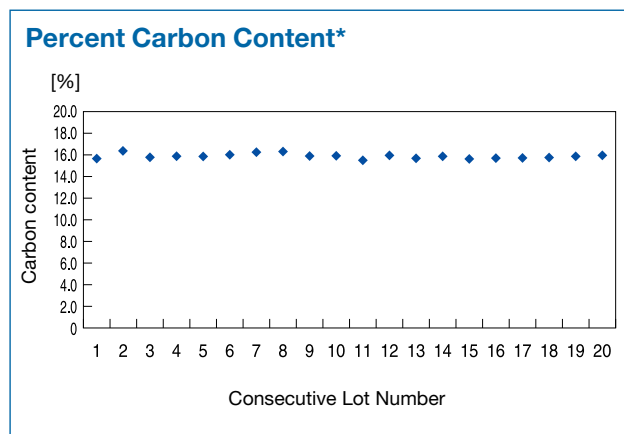

Individual Column Test

To give our customers an insight into the strict criteria with regard to the silica base, the bonded final product and the reproducible chromatographic behaviour, each column of the ProFamily is supplied with a lot inspection report and an individual column test chromatogram. The first report illustrates the narrow window for physical parameters such as particle size distribution or surface area and the reproducibility of chemical properties. The test chromatogram illustrates the efficiency of the column with a guaranteed minimum performance of 100,000 theoretical plates for 150 and 250 x 4.6 mm ID and a tailing factor of 0.90 to 1.15 (at 5% peak height for 5 µm particle size).

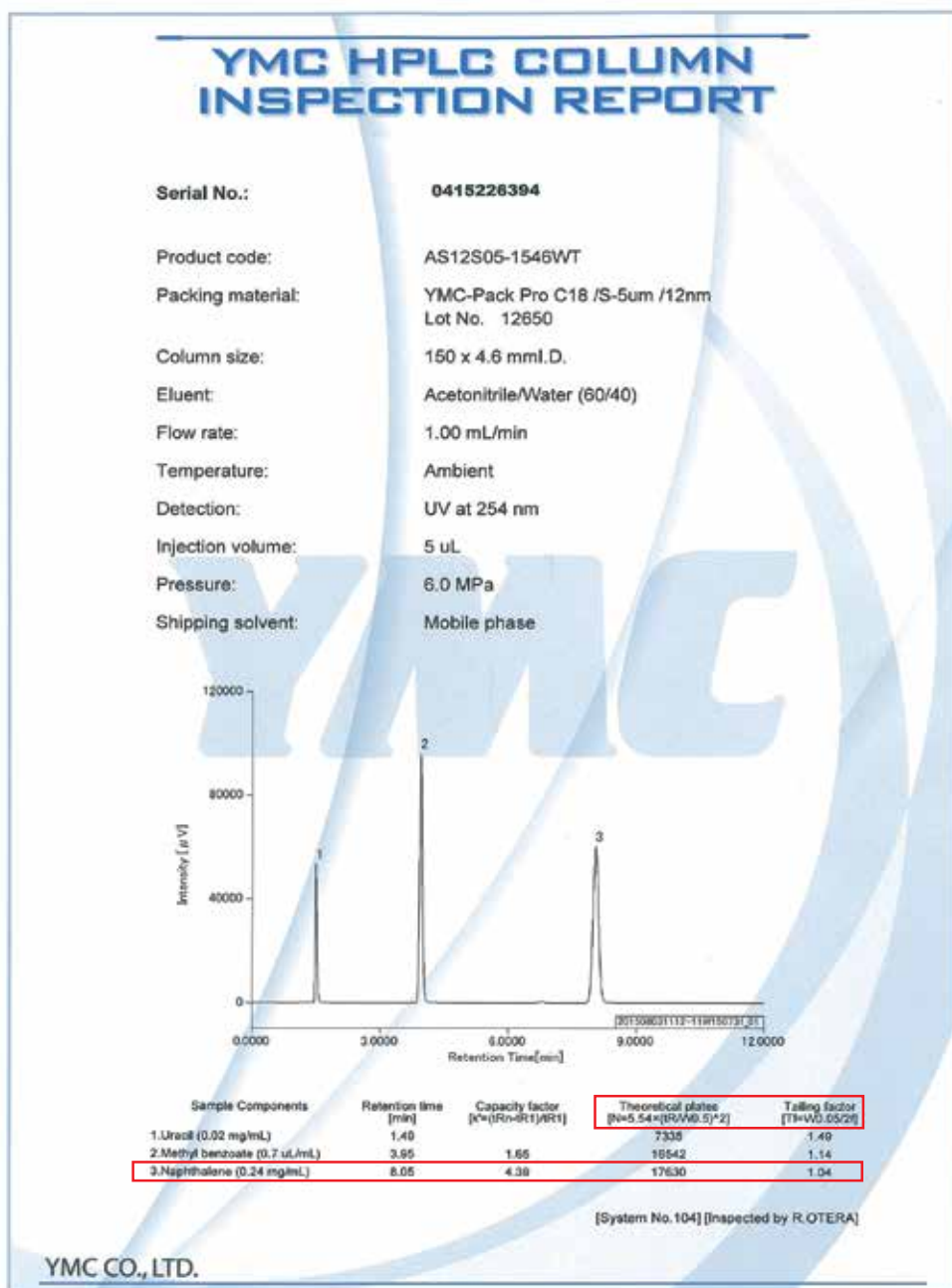

Indicates the efficiency of the column retention characteristics and symmetry of the test peaks

Individual Lot Test

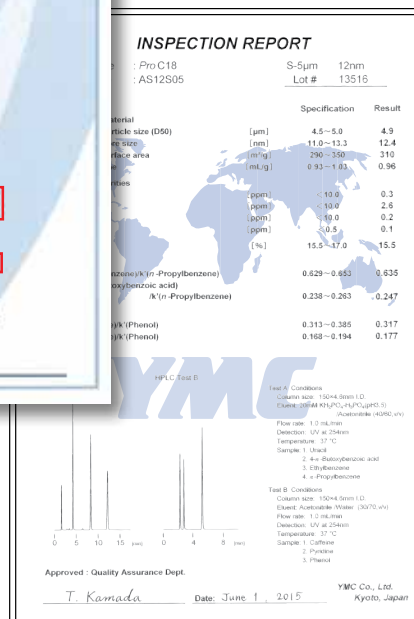

YMC ProFamily

Comparison of separative selectivity

The selectivity characteristics of each column are shown using hydrophobicity and hydrogen-bonding ability as indicators. The ProFamily series of ODS phases is designed to make Hydrosphere C18 and YMC-Pack Pro C18 RS have contrasting separation characteristics, with standard YMC-Pack Pro C18 in between. Also, Pro C8 and C4 have different selectivity from the ODS phases. By choosing one from these 5 types of columns, one can easily optimise the separation of polar and non-polar compounds.

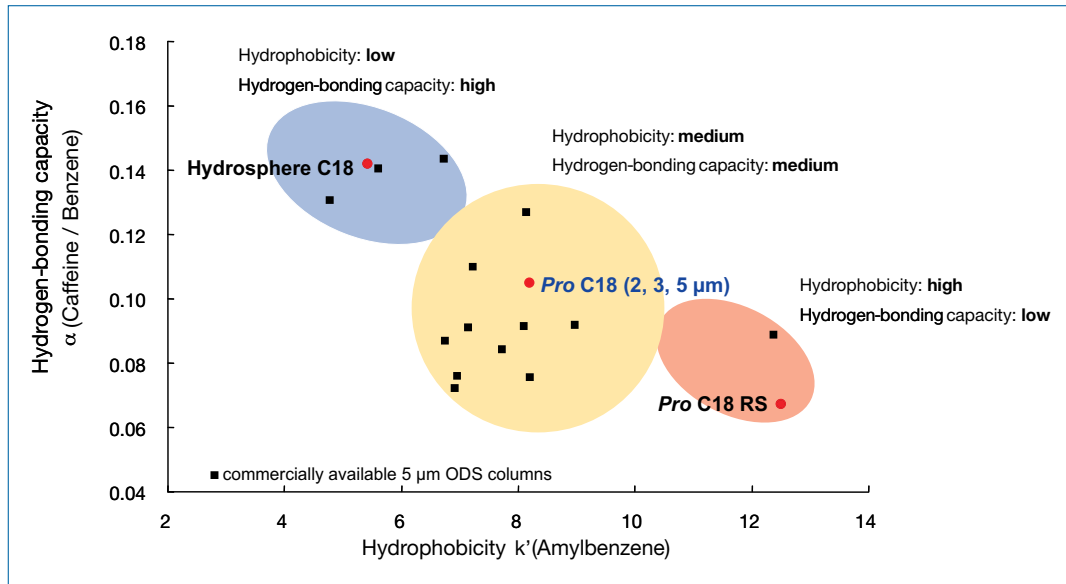

Stability for repetitive analysis

The long-term stability of a YMC-Pack Pro C18 (3 μm) short column used in repeated analysis is shown below. There is no change found in the separation of all compounds after 5000 injections (8 hours/day for 5 months) during gradient analysis.

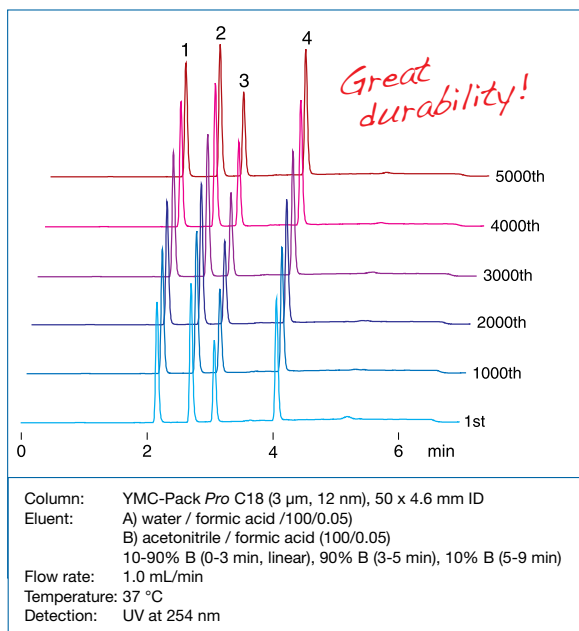

	tR(4)	N(4)	Rs(4-3)
1st	4.06	37700	11.86
1000th	4.05	37600	11.85
2000th	4.05	37600	11.84
3000th	4.05	37600	11.84
4000th	4.06	37800	11.84
5000th	4.06	37800	11.86

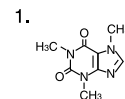

Caffeine

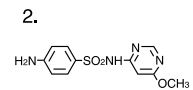

Sulfamonomethoxine

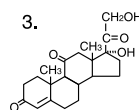

Cortisone

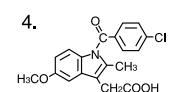

Indomethacin

YMC ProFamily

Hydrophobicity and steric selectivity

This comparison shows the different properties of the ProFamily members giving a good indication on their potential for method development.

The compounds 1. uracil (dead volume marker) 2. *n*-butylbenzene 3. *o*-terphenyl 4. *n*-amylbenzene and 5. triphenylene are used to determine the hydrophobicity (2. and 4.) and the steric selectivity (3. and 5.) of each ProFamily member under unbuffered chromatographic conditions.

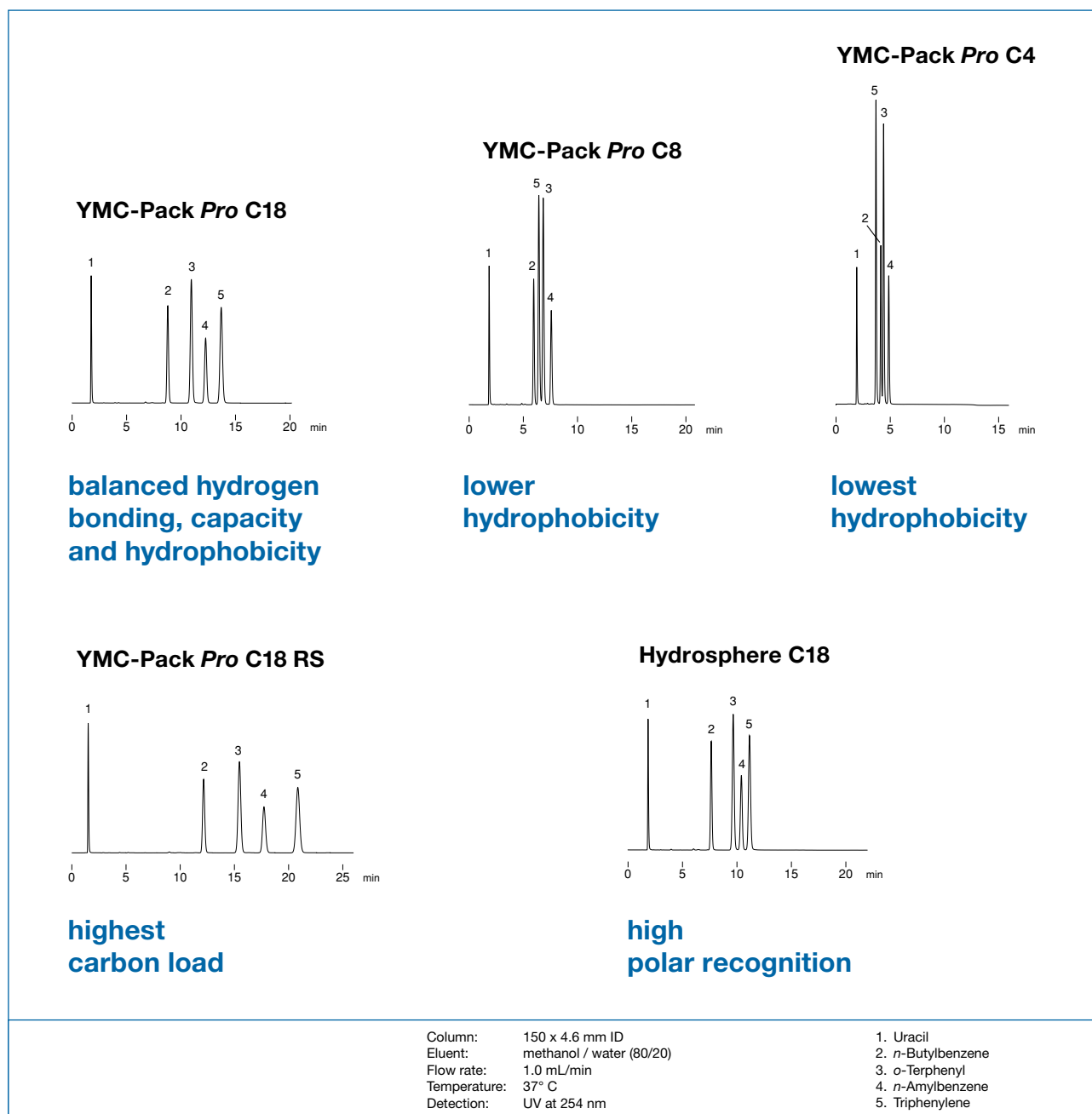

The whole ProFamily covers a large area of hydrophobicity and steric selectivity, as presented in this comparison, which offers the opportunity to accomplish optimisation of chromatographic methods even for complicated separation problems.

YMC ProFamily

Hydrogen bonding capacity

Hydrogen bonding capacity is evaluated by examining the relative retention coefficient as α (caffeine/benzene). Among the ProFamily series both Hydrosphere C18, with low density of C18, and YMC-Pack Pro C4, with short alkyl chain, have high hydrogen-bonding capacity. Benzene with non-polar groups is retained according to hydrophobicity of the packing, while retention of caffeine and phenol (hydrophilic compounds), is greatly affected by hydrogen-bonding capacity, and these packings have similar retention time, but show different selectivity.

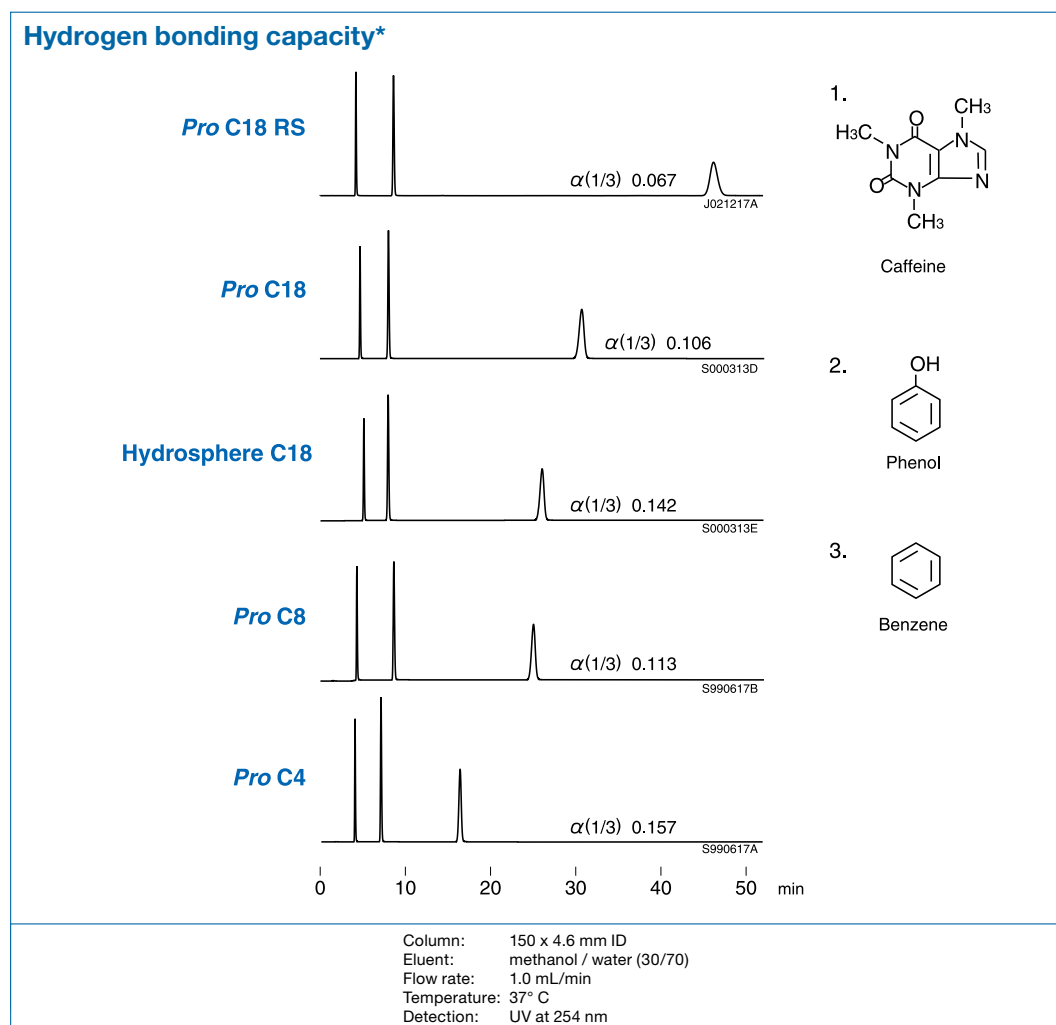

YMC ProFamily

Acidic and basic compounds

Acidic compounds*

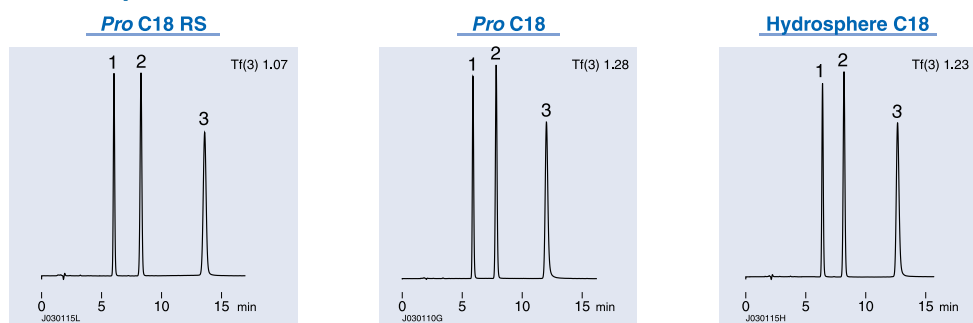

Column: 150 x 4.6 mm ID
 Eluent: 20 mM CH₃COONa-CH₃COOH (pH 4.4) / acetonitrile (80/20)
 Flow rate: 1.0 mL/min
 Temperature: 37° C
 Detection: UV at 230 nm

1. *p*-Hydroxyacetophenone (I.S.)
 2. Sorbic acid
 3. Dehydroacetic acid

Basic compounds*

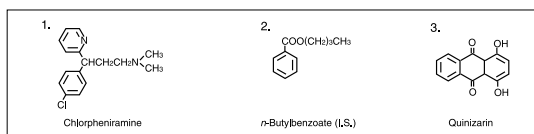
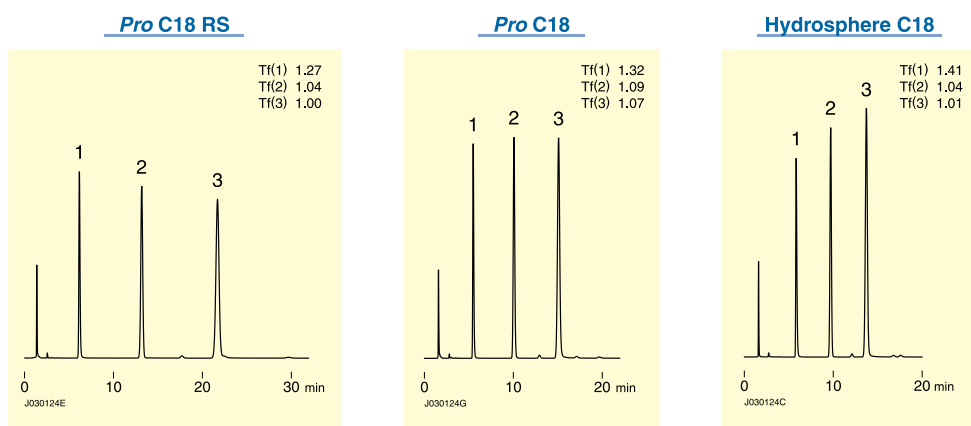

Column: 150 x 4.6 mm ID
 Eluent: 20 mM KH₂PO₄-K₂HPO₄ (pH 6.9) / methanol (30/70)
 Flow rate: 1.0 mL/min
 Temperature: 37° C
 Detection: UV at 254 nm

YMC-Pack Pro C18

- specifically designed for pharmaceutical and biotechnical R&D
- extreme narrow specifications
- high lot-to-lot reproducibility
- high column-to-column reproducibility
- ideal for basic, acidic and polar compounds



YMC-Pack Pro C18	Specification
Particle size / μm	2; 3; 5
Pore size / nm	12
Surface area / m^2g^{-1}	330
Carbon content / %	16
Recommended pH range	2.0 - 8.0

Properties

YMC-Pack Pro C18 is based on an ultra pure silica support, which is used for the whole ProFamily. Due to a proprietary endcapping process especially designed for this type of silica, YMC-Pack Pro C18 is perfectly suitable for the separation of acidic and basic molecules. The inertness of the silica makes it an excellent choice for the analysis of drugs or metabolites, compounds that are susceptible to polar interactions with residual silanol groups and metal impurities as demonstrated in the following comparison. The extreme basic substances are selected to prove the very good performance of YMC-Pack Pro C18 in regard to their separation and the peak performance that cannot be achieved with classical materials.

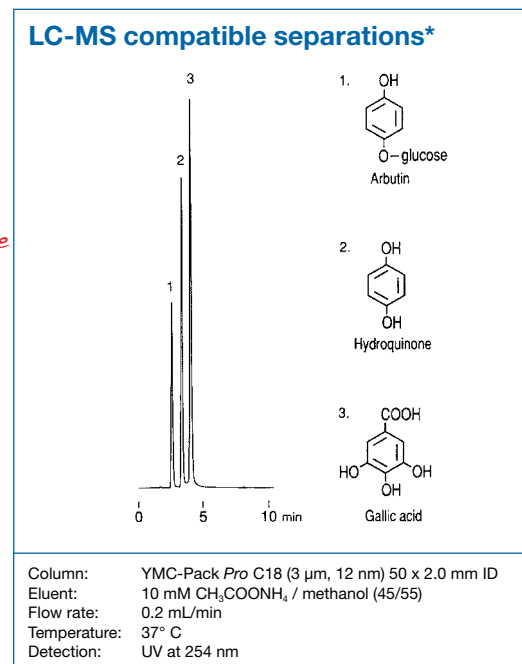
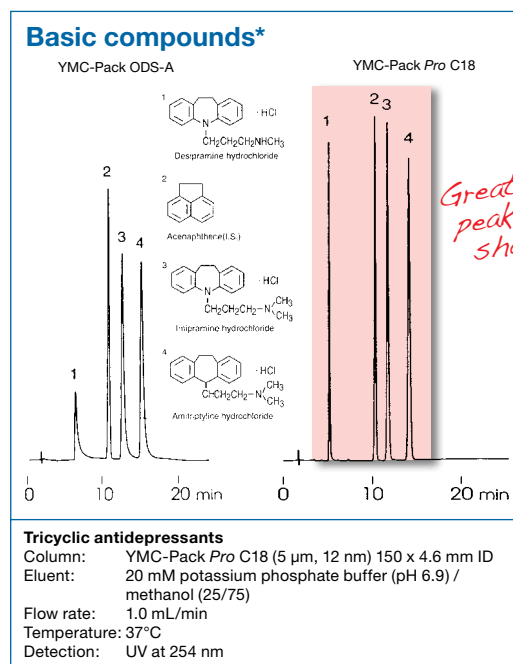

YMC-Pack Pro C18

Application

This small collection of applications can only give a brief insight into the multiple applications for Pro C18.

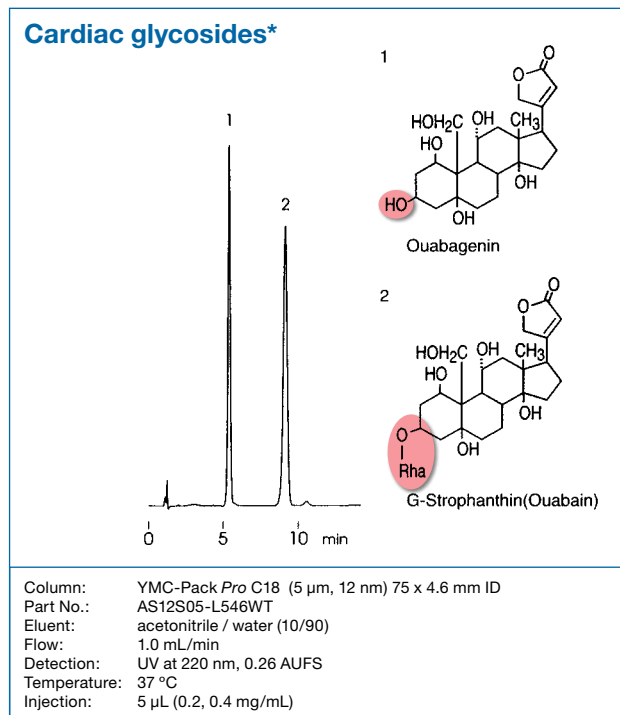
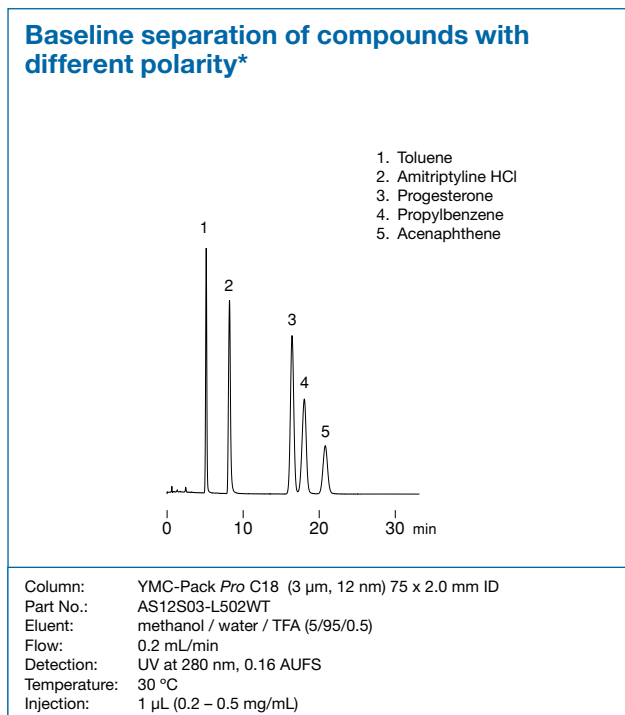
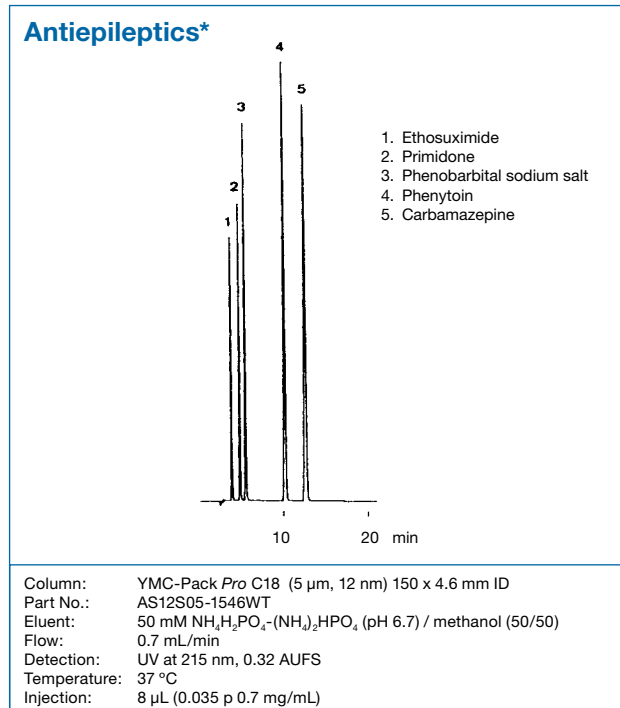
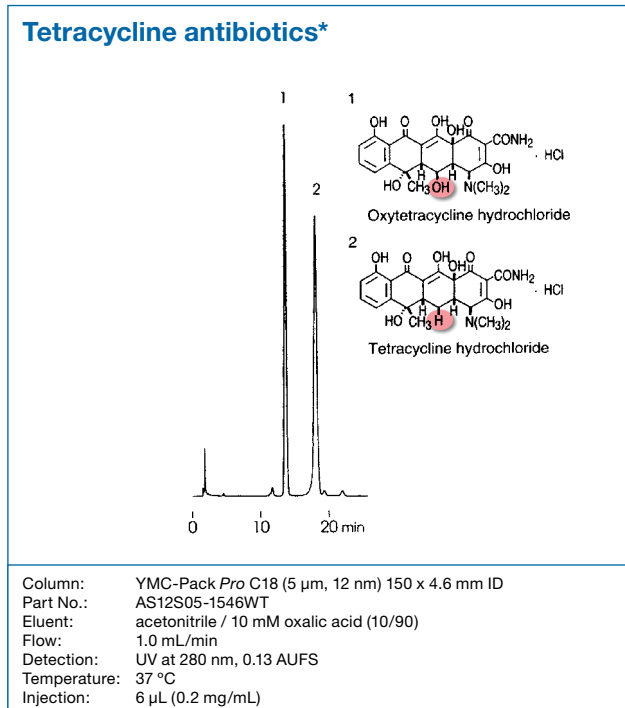

For more applications please refer to our "Application Data Collections" or contact us directly.

Column care

YMC Pack Pro C18 is stable towards hydrolysis between pH 2.0-8.0. Remove acid and buffer salts before storage. Store the column in methanol / water = 70/30.

For detailed information please refer to the "Column Care and Use Instructions" which can be downloaded from www.ymc.de.

YMC-Pack Pro C8

- extremely broad selectivity pattern
- good alternative to C18 phases
- suitable for all types of organic molecules, especially basic pharmaceuticals



YMC-Pack Pro C8	Specification
Particle size / μm	3; 5
Pore size / nm	12
Surface area / m^2g^{-1}	330
Carbon content / %	10
Recommended pH range	2.0 - 7.5

General

Within the *ProFamily*, the YMC-Pack *Pro C8* provides an additional, less hydrophobic stationary phase for all types of compounds, but especially for basic and metal chelating substances. For many applications regarding the separation of peptides, nucleic acids and similar compounds with LC-MS detection, conventional C8-stationary phases require ion pair reagents and ion-suppression to obtain satisfactory separation and low detection limits. In contrast, *Pro C8* with its ultra pure silica allows the analysis without these modifiers but still generates excellent chromatograms. In addition to the reduced hydrophobicity of YMC-Pack *Pro C8* compared with YMC-Pack *Pro C18*, the different steric selectivity offers new possibilities in method optimisation as demonstrated in the figure below:

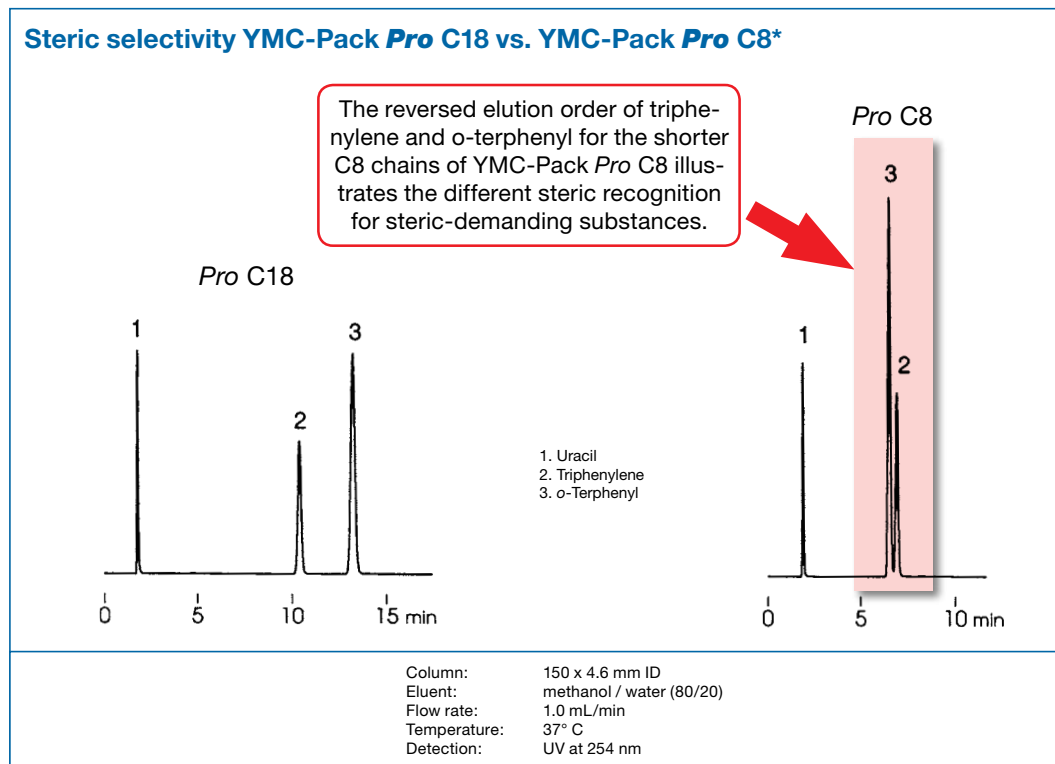

YMC-Pack Pro C8

YMC-Pack Pro C8 is a member of the ProFamily and as a result gives excellent peak shapes even for basic substances, due to its low metal content and the endcapping procedure, which is identical to that used for YMC-Pack Pro C18. This shall be demonstrated in the comparison below where YMC-Pack Pro C8 outperforms competitive state of the art products.

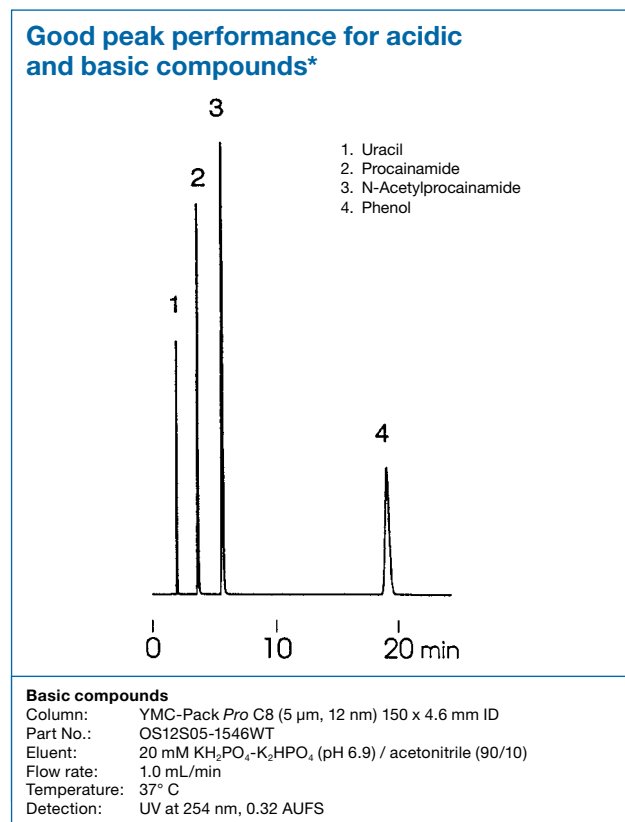
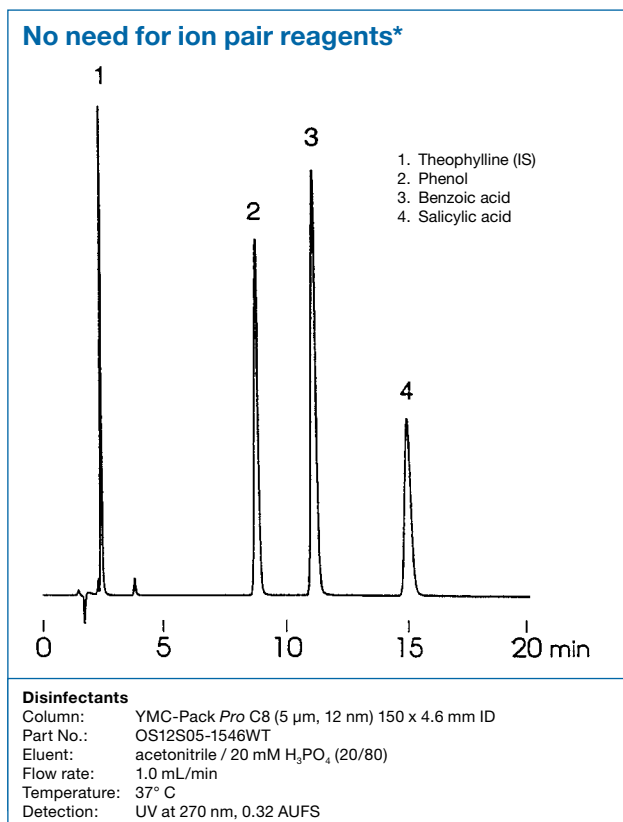
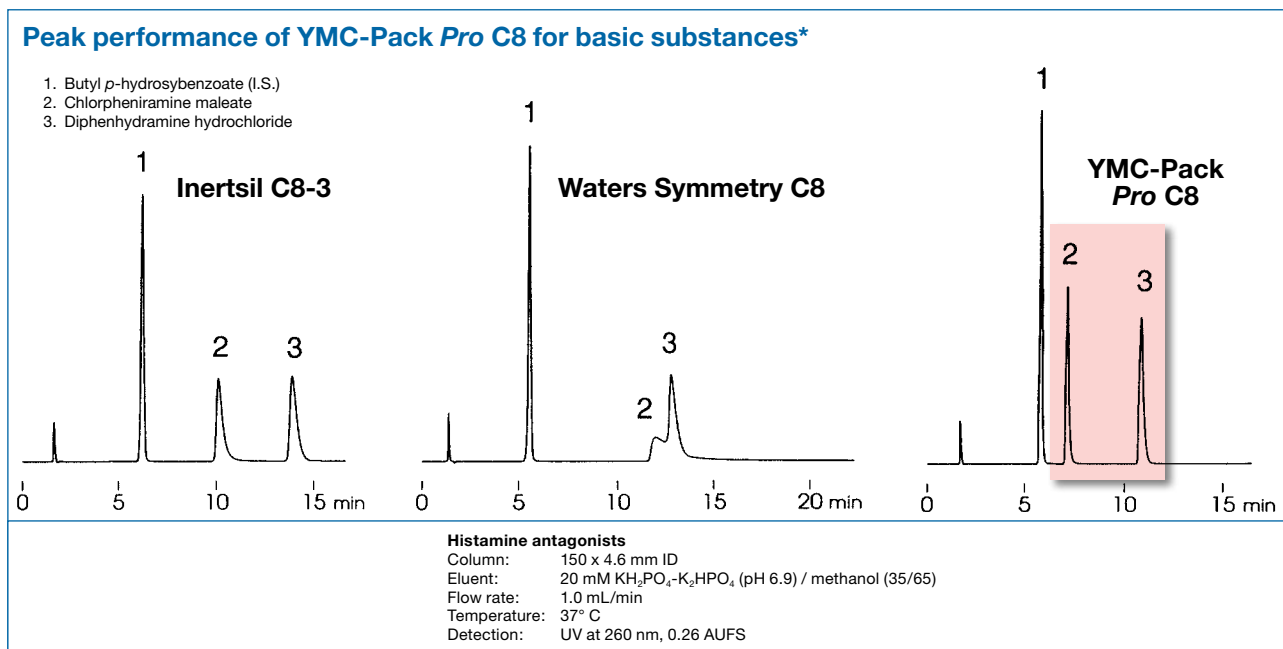

For more applications please refer to our "Application Data Collections" or contact us directly.

Column care

YMC-Pack Pro C8 is stable towards hydrolysis between pH 2.0-7.5. Remove acid and buffer salts before storage. Store the column in methanol / water = 70/30.

For detailed information please refer to the "Column Care and Use Instructions" which can be downloaded from www.ymc.de.

YMC-Pack Pro C4

- proprietary endcapping in order to minimize the effect of residual silanols
- for polar organic molecules, especially basic pharmaceuticals and peptides
- ideal for fast chromatography



YMC-Pack Pro C4	Specification
Particle size / μm	3; 5
Pore size / nm	12
Surface area / m^2g^{-1}	330
Carbon content / %	7
Recommended pH range	2.0 - 7.5

General

More than 80% of the reversed phase analyses are accomplished on octyl or octadecyl phases. Because of this overwhelming majority, many chromatographers neglect other selectivities that might be better suited to their separation, such as butyl phases. With *Pro C4*, YMC offers a stationary phase based on the well-known ultra pure silica of the *ProFamily*. Compared to a C18 phase with the same eluent, this less hydrophobic material gives shorter retention times for non-polar compounds while the retention time of polar analytes are virtually unaffected. This makes the *Pro C4* an interesting alternative especially when short analysis times are required. For this reason, mixtures with a wide range of component polarity are best analysed by short chains, such as YMC-Pack *Pro C4*.

Within the *ProFamily*, YMC-Pack *Pro C4* is the selectivity of choice to reduce time of analysis in combination with the given advantages of the *ProFamily*, namely the high purity silica support and the low metal content, which result in excellent peak performance as below.

Efficient separation of pharmaceutical drugs*

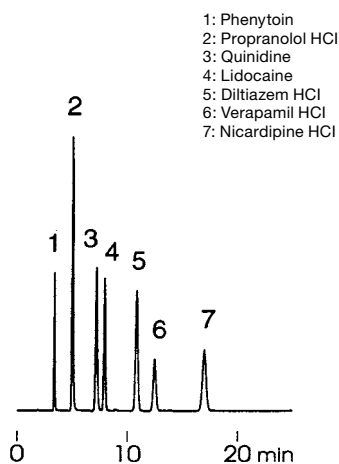

Antiarrhythmic drugs

Column: YMC-Pack *Pro C4* (5 μm , 12 nm) 150 x 4.6 mm ID
Part No.: BS12S05-1546WT
Eluent: 20 mM KH_2PO_4 - K_2HPO_4 (pH 6.9)/methanol (40/60)
Flow rate: 1.0 mL/min
Temperature: 37° C
Detection: UV at 220 nm

Fast separation of nucleic acid bases*

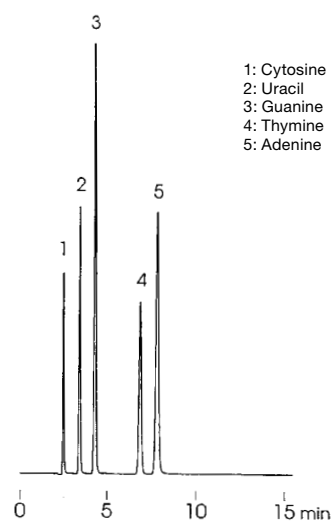

Nucleic acid bases

Column: YMC-Pack *Pro C4* (5 μm , 12 nm) 150 x 4.6 mm ID
Part No.: BS12S05-1546WT
Eluent: 20 mM KH_2PO_4
Flow rate: 1.0 mL/min
Temperature: 37° C
Detection: UV at 254 nm

YMC-Pack Pro C4

The comparison shown below demonstrates that YMC-Pack Pro C4 is the column of choice when fast HPLC is required. There is almost no difference in retention times for the first three compounds whilst Nicardipine HCl elutes faster on YMC-Pack Pro C4 due to its lower polarity.

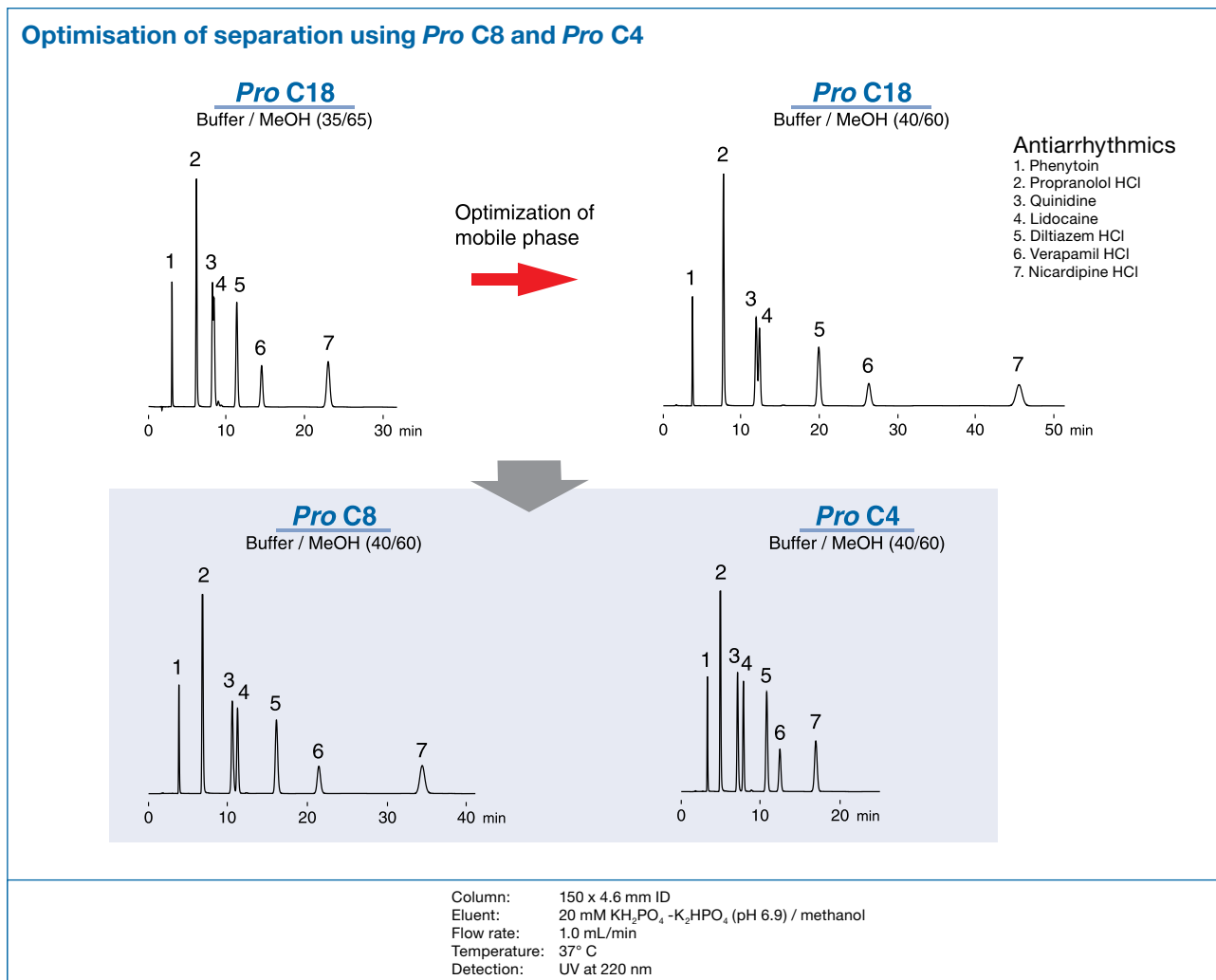

For more applications please refer to our "Application Data Collections" or contact us directly.

Column care

YMC-Pack Pro C4 is stable towards hydrolysis between pH 2.0-7.5. Remove acid and buffer salts before storage. Store the column in methanol / water = 70/30. Clogged inlet frits often can be cleaned by changing the flow direction or replacement. For detailed information please refer to the "Column Care and Use Instructions" which can be downloaded from www.ymc.de.

YMC-Pack Pro C18 RS

- strongly hydrophobic due to carbon content of 22%
- exhibits extraordinary steric selectivity
- extended pH and temperature stability
- for the separation of hydrophobic, acidic and basic molecules



YMC-Pack Pro C18 RS	Specification
Particle size / μm	3; 5
Pore size / nm	8
Surface area / m^2g^{-1}	510
Carbon content / %	22
Recommended pH range	1.0 - 10.0*

* it is recommended to use at least 10% organic solvent composition near the pH limits and over 50% at pH values above pH 9.0 to preserve column lifetimes

General

The relatively high carbon load of YMC-Pack Pro C18 RS with 22% amplifies the selectivity's ability to discriminate between closely related compounds such as positional or steric isomers. A good system to test this steric selectivity is a mixture of *o*-, *m*- and *p*-terphenyl separated under methanol/water conditions. These three compounds differ only in their three-dimensional structure and not in their hydrophobicity or polarity. YMC-Pack Pro C18 RS recognizes even slight steric differences as shown in the chromatogram on the right, whilst a more conventional carbon load (15%) C18 chemistry does not.

Steric selectivity*

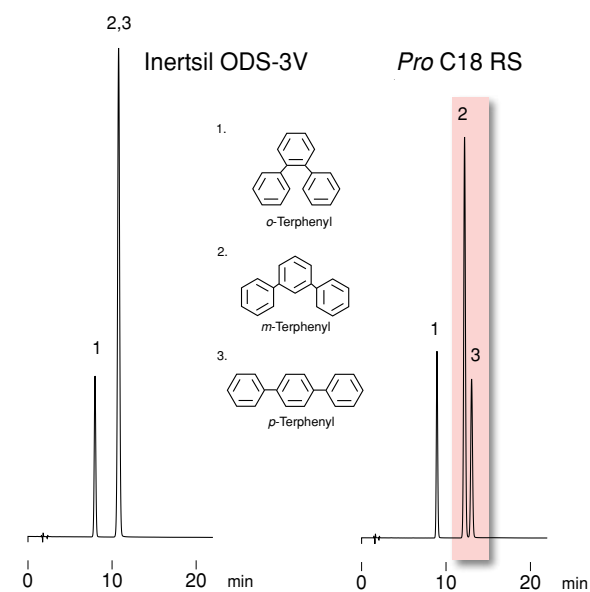

Column: 150 x 4.6 mm ID
 Eluent: methanol / water (85/15)
 Flow rate: 1.0 mL/min
 Temperature: 37° C
 Detection: UV at 254 nm

YMC-Pack Pro C18 RS

Stability under acidic conditions*

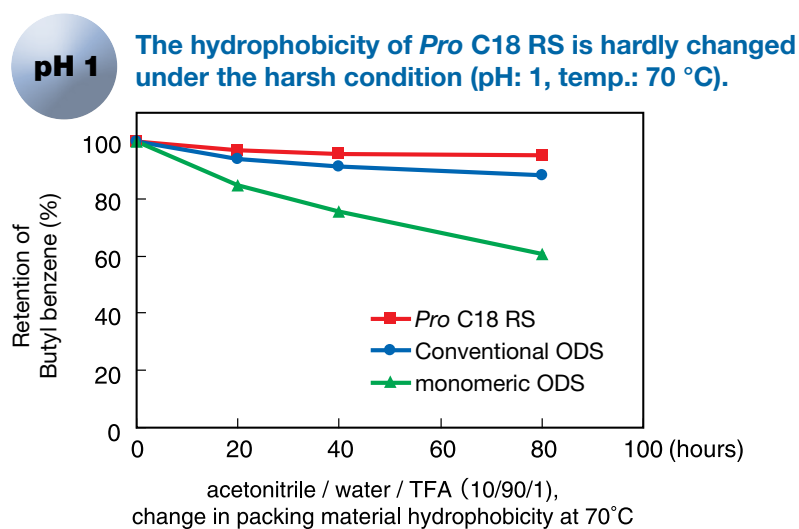

Note: When assessing pH stability data, please take care to certify that complete chromatographic conditions are presented.

Stability under basic conditions*

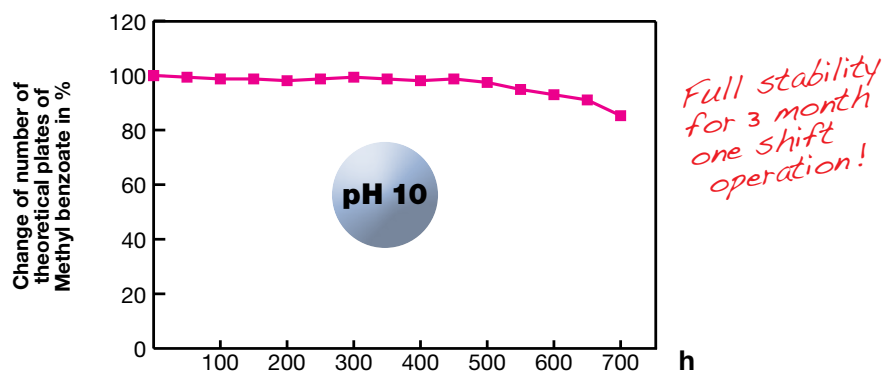

For pH 10, a borate buffer system (20 mM H₃BO₃-NaOH (pH 9.8) / methanol 50/50 at 30°C) was selected to be continuously pumped through the column, while checking the number of theoretical plates for methyl benzoate every 50 hours.

Basic eluents may significantly affect silicas and traditional bonding chemistries. Therefore, stability data should be considered only after verifying that the buffer system used maintains the selected pH during preparation and use. Furthermore, it must be verified that the eluent is not recycled, since the “active” basic sites may equilibrate to a saturation level with time, resulting in no further interactions taking place. Consequently, only continuous flow of “fresh” and thoroughly buffered eluent will provide accurate and meaningful performance data.

YMC-Pack Pro C18 RS

YMC-Pack Pro C18 RS:

Ideal for the separation of steric demanding compounds and/or for use under broader pH conditions!

Method optimization*

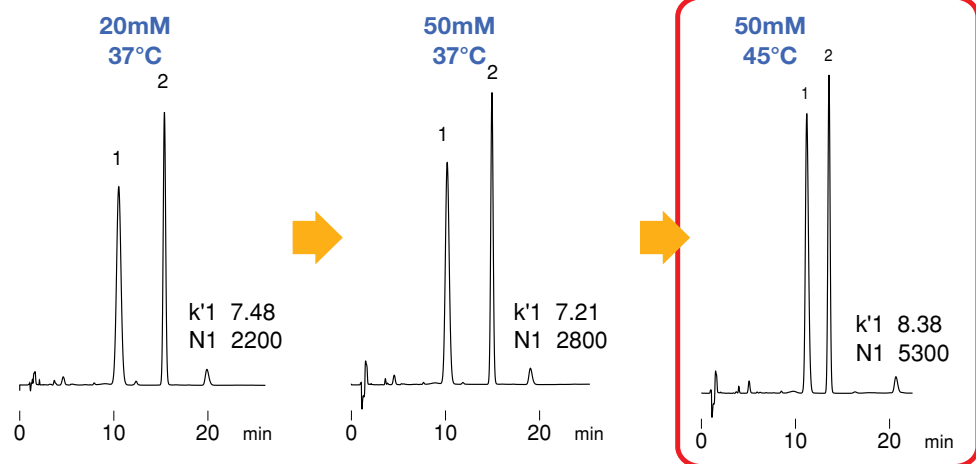
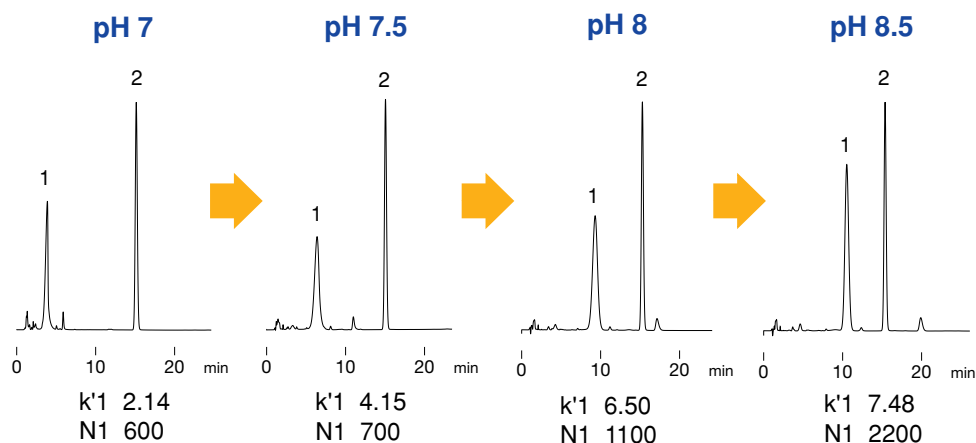

Column: YMC-Pack Pro C18 RS (5 μ m, 8 nm) 150 x 4.6 mm ID
 Part No.: RS08S05-1546WT
 Eluent: potassium phosphate buffer (pH 8.5) / acetonitrile (50/50)
 Flow rate: 1.0 mL/min
 Temperature: 37°C
 Detection: UV at 210 nm

YMC-Pack Pro C18 RS

Applications

The specific properties of YMC-Pack Pro C18 RS make it an excellent choice for the separation of non-polar structurally related analytes. The extended resistance towards acidic and basic conditions not only widens the possibilities in method development but also provides further selectivities for demanding separations such as LC-MS or combinatorial chemistry of: positional isomers, large hydrophobic molecules, basic and acidic compounds, peptides

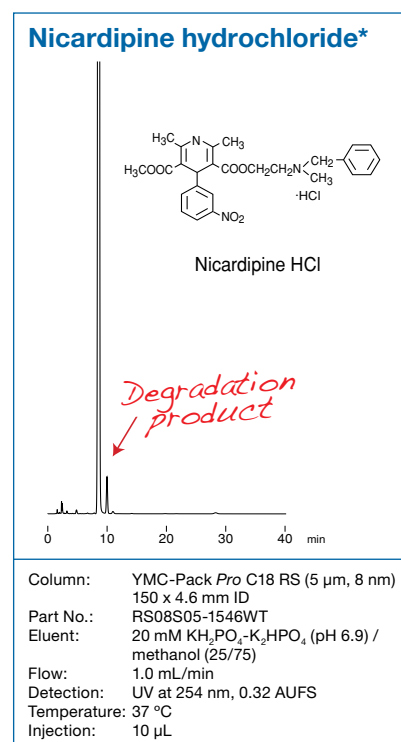
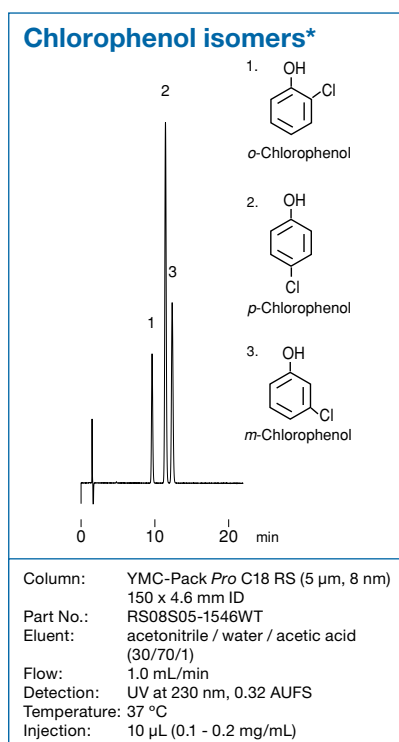
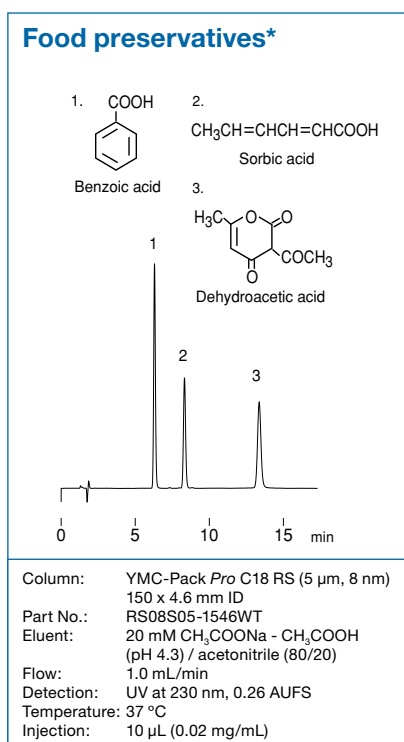
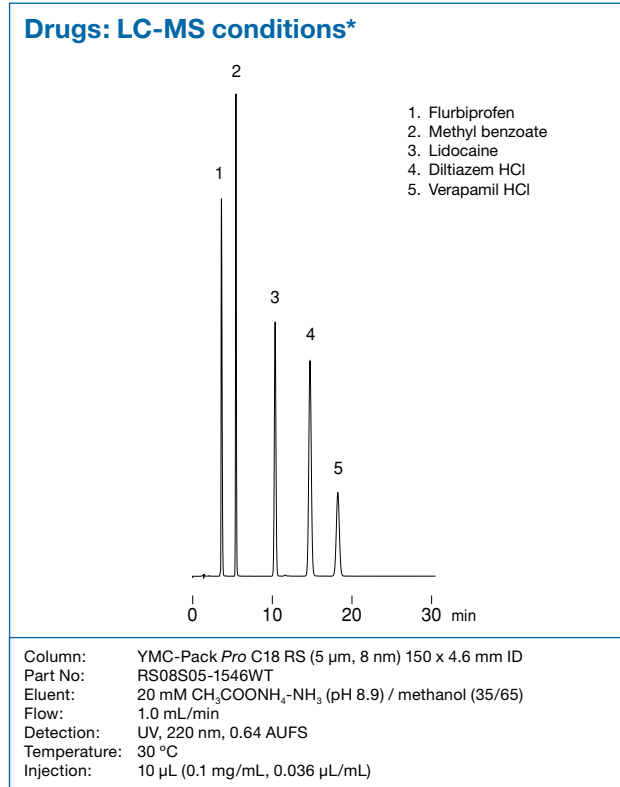
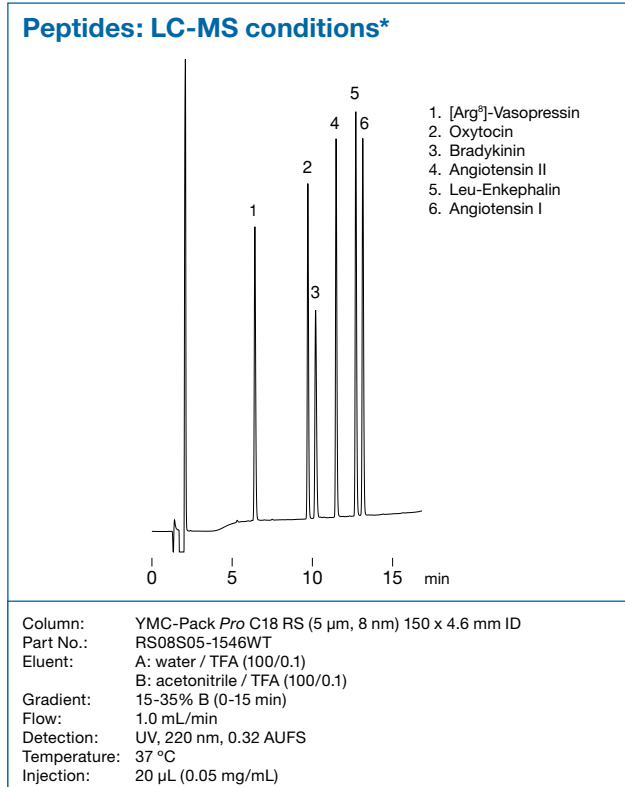

For more applications please refer to our "Application Data Collections" or contact us directly.

Hydrosphere C18

- stable under the use of 100% aqueous eluent
- "hydrophilic" C18 surface for enhanced polar recognition
- no need for ion pair reagents
- based on highly inert, ultrapure, pH neutral silica
- specifically designed for pharmaceutical and biotechnology R&D



Hydrosphere C18	Specification
Particle size / μm	2; 3; 5
Pore size / nm	12
Surface area / m^2g^{-1}	330
Carbon content / %	12
Recommended pH range	2.0 - 8.0

General

The separation of polar compounds in many cases requires highly aqueous mobile phase conditions to achieve sufficient retention on the stationary phase. Conventional reversed phase selectivities do not give reproducible results under these conditions due mainly to the collapse of the C18 chains, Hydrosphere C18 has been developed, on the ultra pure silica support of the ProFamily, as the next generation of speciality phases following the well known YMC-Pack ODS-AQ, which was developed in 1987 and is still a very interesting selectivity option for these purposes.

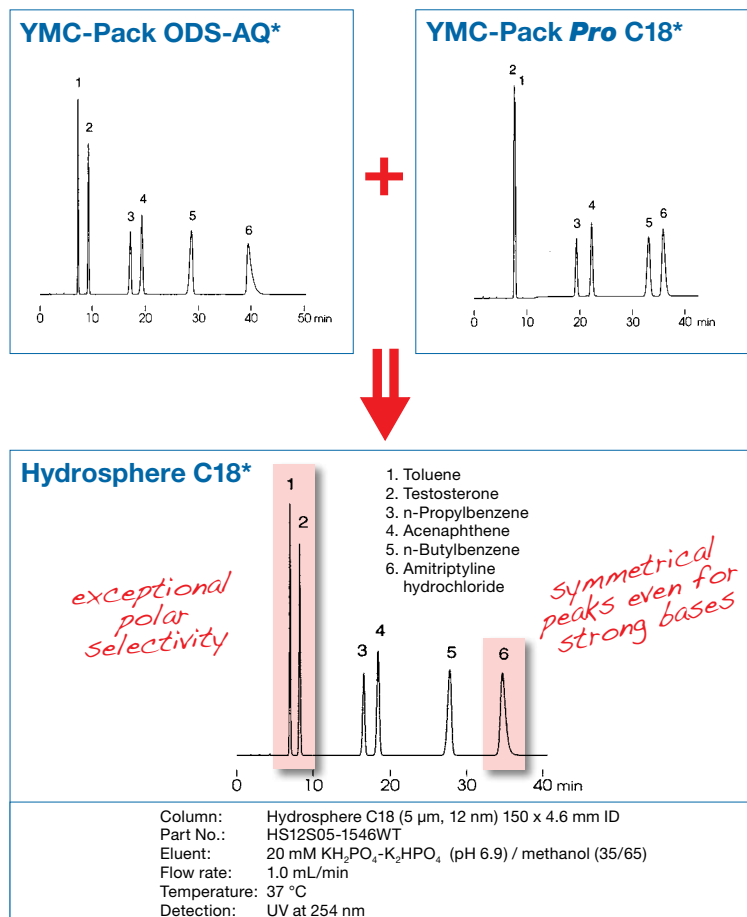

Hydrosphere C18

Solution: Hydrosphere C18 under 100% aqueous chromatographic conditions*

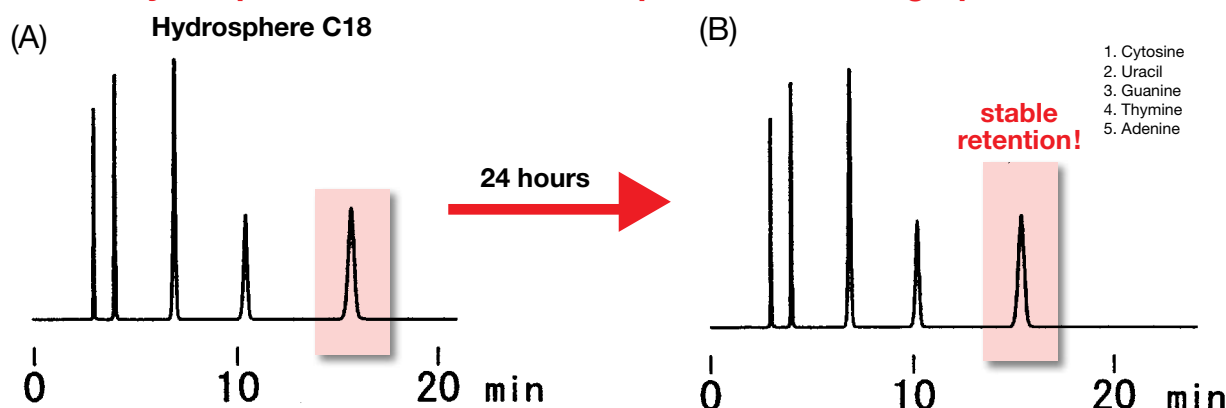

Column: Hydrosphere C18 (5 μ m, 12 nm) 150 x 4.6 mm ID
Part No.: HS12S05-1546WT
Eluent: 20 mM KH_2PO_4 - K_2HPO_4 (pH 6.9)
Flow rate: 1.0 mL/min
Temperature: 37 °C
Detection: UV at 254 nm

After use, the column was stored overnight without any washing procedure. The next day, the application was continued.

Its "hydrophilic" C18 surface gives Hydrosphere C18 the capability to show stable retention times even after 24 hours under these chromatographic conditions.

No ion pair reagent required*

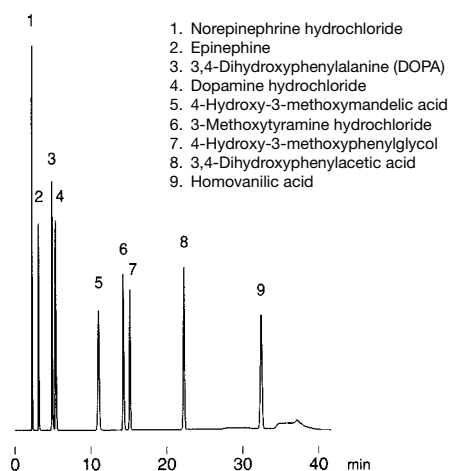

Catecholamines

Column: Hydrosphere C18 (5 μ m, 12 nm) 150 x 4.6 mm ID
Part No.: HS12S05-1546WT
Eluent: A) 50 mM KH_2PO_4 - H_3PO_4 (pH 3.1)
B) 50 mM KH_2PO_4 - H_3PO_4 (pH 3.1) / acetonitrile (90/10)
0% B (0-5 min), 0-100% B (5-25 min, linear), 100% B (25-35 min)
Flow: 1.0 mL/min
Detection: UV at 280 nm, 0.64 AUFS
Temperature: 30 °C
Injection: 10 μ L (0.15 - 0.25 mg/mL)

Efficient separation of complex substance mixtures*

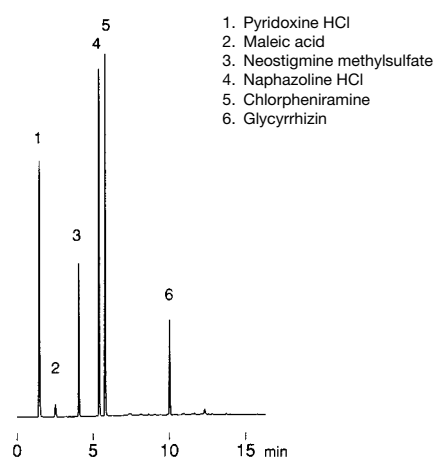

Ingredients in an eye drop

Column: Hydrosphere C18 (3 μ m, 12 nm) 50 x 4.6 mm ID
Part No.: HS12S03-0546WT
Eluent: A) 20 mM KH_2PO_4 - H_3PO_4 (pH 2.5)
B) acetonitrile
0-60% B (0-10 min), 60% B (10-15 min)
Flow rate: 1.0 mL/min
Temperature: 37 °C
Detection: UV at 265 nm, 0.128 AUFS
Injection: 5 μ L (0.03 - 0.3 mg/mL)

For more applications please refer to our "Application Data Collections" or contact us directly.

Column care

Hydrosphere C18 is stable towards hydrolysis between pH 2.0-8.0 in up to 100% aqueous systems and a maximum of 50 °C. Remove acid and buffer salts before storage. Store the column in methanol / water = 70/30.

For detailed information please refer to the "Column Care and Use Instructions" which can be downloaded from www.ymc.de.

Ordering Information

YMC-Pack Pro C18

Phase dimension	Column ID [mm]	Column length [mm]					Guard cartridges* with 10 mm length [pack of 5]
		30 (WT) / 33 (QT)	50	100	150	250	
12 nm 2 µm	2.1	AS12S02-H3Q1QT	AS12S02-05Q1QT	AS12S02-10Q1QT	AS12S02-15Q1QT	AS12S02-25Q1QT	AS12S02-01Q1GC
	3.0	AS12S02-H303QT	AS12S02-0503QT	AS12S02-1003QT	AS12S02-1503QT	AS12S02-2503QT	AS12S02-0103GC
	4.0	AS12S02-H304QT	AS12S02-0504QT	AS12S02-1004QT	AS12S02-1504QT	AS12S02-2504QT	AS12S02-0104GC
	4.6	AS12S02-0346WT	AS12S02-0546WT	AS12S02-1046WT	AS12S02-1546WT	AS12S02-2546WT	AS12S02-0104GC
12 nm 3 µm	2.1	AS12S03-H3Q1QT	AS12S03-05Q1QT	AS12S03-10Q1QT	AS12S03-15Q1QT	AS12S03-25Q1QT	AS12S03-01Q1GC
	3.0	AS12S03-H303QT	AS12S03-0503QT	AS12S03-1003QT	AS12S03-1503QT	AS12S03-2503QT	AS12S03-0103GC
	4.0	AS12S03-H304QT	AS12S03-0504QT	AS12S03-1004QT	AS12S03-1504QT	AS12S03-2504QT	AS12S03-0104GC
	4.6	AS12S03-0346WT	AS12S03-0546WT	AS12S03-1046WT	AS12S03-1546WT	AS12S03-2546WT	AS12S03-0104GC
12 nm 5 µm	2.1	AS12S05-H3Q1QT	AS12S05-05Q1QT	AS12S05-10Q1QT	AS12S05-15Q1QT	AS12S05-25Q1QT	AS12S05-01Q1GC
	3.0	AS12S05-H303QT	AS12S05-0503QT	AS12S05-1003QT	AS12S05-1503QT	AS12S05-2503QT	AS12S05-0103GC
	4.0	AS12S05-H304QT	AS12S05-0504QT	AS12S05-1004QT	AS12S05-1504QT	AS12S05-2504QT	AS12S05-0104GC
	4.6	AS12S05-0346WT	AS12S05-0546WT	AS12S05-1046WT	AS12S05-1546WT	AS12S05-2546WT	AS12S05-0104GC

*Guard cartridge holder required, part no. XPGCH-Q1

YMC-Pack Pro C8

Phase dimension	Column ID [mm]	Column length [mm]					Guard cartridges* with 10 mm length [pack of 5]
		30 (WT) / 33 (QT)	50	100	150	250	
12 nm 3 µm	2.1	OS12S03-H3Q1QT	OS12S03-05Q1QT	OS12S03-10Q1QT	OS12S03-15Q1QT	OS12S03-25Q1QT	OS12S03-01Q1GC
	3.0	OS12S03-H303QT	OS12S03-0503QT	OS12S03-1003QT	OS12S03-1503QT	OS12S03-2503QT	OS12S03-0103GC
	4.0	OS12S03-H304QT	OS12S03-0504QT	OS12S03-1004QT	OS12S03-1504QT	OS12S03-2504QT	OS12S03-0104GC
	4.6	OS12S03-0346WT	OS12S03-0546WT	OS12S03-1046WT	OS12S03-1546WT	OS12S03-2546WT	OS12S03-0104GC
12 nm 5 µm	2.1	OS12S05-H3Q1QT	OS12S05-05Q1QT	OS12S05-10Q1QT	OS12S05-15Q1QT	OS12S05-25Q1QT	OS12S05-01Q1GC
	3.0	OS12S05-H303QT	OS12S05-0503QT	OS12S05-1003QT	OS12S05-1503QT	OS12S05-2503QT	OS12S05-0103GC
	4.0	OS12S05-H304QT	OS12S05-0504QT	OS12S05-1004QT	OS12S05-1504QT	OS12S05-2504QT	OS12S05-0104GC
	4.6	OS12S05-0346WT	OS12S05-0546WT	OS12S05-1046WT	OS12S05-1546WT	OS12S05-2546WT	OS12S05-0104GC

*Guard cartridge holder required, part no. XPGCH-Q1

YMC-Pack Pro C4

Phase dimension	Column ID [mm]	Column length [mm]					Guard cartridges* with 10 mm length [pack of 5]
		30 (WT) / 33 (QT)	50	100	150	250	
12 nm 3 µm	2.1	BS12S03-H3Q1QT	BS12S03-05Q1QT	BS12S03-10Q1QT	BS12S03-15Q1QT	BS12S03-25Q1QT	BS12S03-01Q1GC
	3.0	BS12S03-H303QT	BS12S03-0503QT	BS12S03-1003QT	BS12S03-1503QT	BS12S03-2503QT	BS12S03-0103GC
	4.0	BS12S03-H304QT	BS12S03-0504QT	BS12S03-1004QT	BS12S03-1504QT	BS12S03-2504QT	BS12S03-0104GC
	4.6	BS12S03-0346WT	BS12S03-0546WT	BS12S03-1046WT	BS12S03-1546WT	BS12S03-2546WT	BS12S03-0104GC
12 nm 5 µm	2.1	BS12S05-H3Q1QT	BS12S05-05Q1QT	BS12S05-10Q1QT	BS12S05-15Q1QT	BS12S05-25Q1QT	BS12S05-01Q1GC
	3.0	BS12S05-H303QT	BS12S05-0503QT	BS12S05-1003QT	BS12S05-1503QT	BS12S05-2503QT	BS12S05-0103GC
	4.0	BS12S05-H304QT	BS12S05-0504QT	BS12S05-1004QT	BS12S05-1504QT	BS12S05-2504QT	BS12S05-0104GC
	4.6	BS12S05-0346WT	BS12S05-0546WT	BS12S05-1046WT	BS12S05-1546WT	BS12S05-2546WT	BS12S05-0104GC

*Guard cartridge holder required, part no. XPGCH-Q1

Ordering Information

YMC-Pack Pro C18 RS

Phase dimension	Column ID [mm]	Column length [mm]					Guard cartridges* with 10 mm length [pack of 5]
		30 (WT) / 33 (QT)	50	100	150	250	
8 nm 3 µm	2.1	RS08S03-H3Q1QT	RS08S03-05Q1QT	RS08S03-10Q1QT	RS08S03-15Q1QT	RS08S03-25Q1QT	RS08S03-01Q1GC
	3.0	RS08S03-H303QT	RS08S03-0503QT	RS08S03-1003QT	RS08S03-1503QT	RS08S03-2503QT	RS08S03-0103GC
	4.0	RS08S03-H304QT	RS08S03-0504QT	RS08S03-1004QT	RS08S03-1504QT	RS08S03-2504QT	RS08S03-0104GC
	4.6	RS08S03-0346WT	RS08S03-0546WT	RS08S03-1046WT	RS08S03-1546WT	RS08S03-2546WT	RS08S03-0104GC
8 nm 5 µm	2.1	RS08S05-H3Q1QT	RS08S05-05Q1QT	RS08S05-10Q1QT	RS08S05-15Q1QT	RS08S05-25Q1QT	RS08S05-01Q1GC
	3.0	RS08S05-H303QT	RS08S05-0503QT	RS08S05-1003QT	RS08S05-1503QT	RS08S05-2503QT	RS08S05-0103GC
	4.0	RS08S05-H304QT	RS08S05-0504QT	RS08S05-1004QT	RS08S05-1504QT	RS08S05-2504QT	RS08S05-0104GC
	4.6	RS08S05-0346WT	RS08S05-0546WT	RS08S05-1046WT	RS08S05-1546WT	RS08S05-2546WT	RS08S05-0104GC

*Guard cartridge holder required, part no. XPGCH-Q1

Hydrosphere C18

Phase dimension	Column ID [mm]	Column length [mm]					Guard cartridges* with 10 mm length [pack of 5]
		30 (WT) / 33 (QT)	50	100	150	250	
12 nm 2 µm	2.1	HS12S02-H3Q1QT	HS12S02-05Q1QT	HS12S02-10Q1QT	HS12S02-15Q1QT	HS12S02-25Q1QT	HS12S02-01Q1GC
	3.0	HS12S02-H303QT	HS12S02-0503QT	HS12S02-1003QT	HS12S02-1503QT	HS12S02-2503QT	HS12S02-0103GC
	4.0	HS12S02-H304QT	HS12S02-0504QT	HS12S02-1004QT	HS12S02-1504QT	HS12S02-2504QT	HS12S02-0104GC
	4.6	HS12S02-0346WT	HS12S02-0546WT	HS12S02-1046WT	HS12S02-1546WT	HS12S02-2546WT	HS12S02-0104GC
12 nm 3 µm	2.1	HS12S03-H3Q1QT	HS12S03-05Q1QT	HS12S03-10Q1QT	HS12S03-15Q1QT	HS12S03-25Q1QT	HS12S03-01Q1GC
	3.0	HS12S03-H303QT	HS12S03-0503QT	HS12S03-1003QT	HS12S03-1503QT	HS12S03-2503QT	HS12S03-0103GC
	4.0	HS12S03-H304QT	HS12S03-0504QT	HS12S03-1004QT	HS12S03-1504QT	HS12S03-2504QT	HS12S03-0104GC
	4.6	HS12S03-0346WT	HS12S03-0546WT	HS12S03-1046WT	HS12S03-1546WT	HS12S03-2546WT	HS12S03-0104GC
12 nm 5 µm	2.1	HS12S05-H3Q1QT	HS12S05-05Q1QT	HS12S05-10Q1QT	HS12S05-15Q1QT	HS12S05-25Q1QT	HS12S05-01Q1GC
	3.0	HS12S05-H303QT	HS12S05-0503QT	HS12S05-1003QT	HS12S05-1503QT	HS12S05-2503QT	HS12S05-0103GC
	4.0	HS12S05-H304QT	HS12S05-0504QT	HS12S05-1004QT	HS12S05-1504QT	HS12S05-2504QT	HS12S05-0104GC
	4.6	HS12S05-0346WT	HS12S05-0546WT	HS12S05-1046WT	HS12S05-1546WT	HS12S05-2546WT	HS12S05-0104GC

*Guard cartridge holder required, part no. XPGCH-Q1

For other dimensions please refer to page 352-353



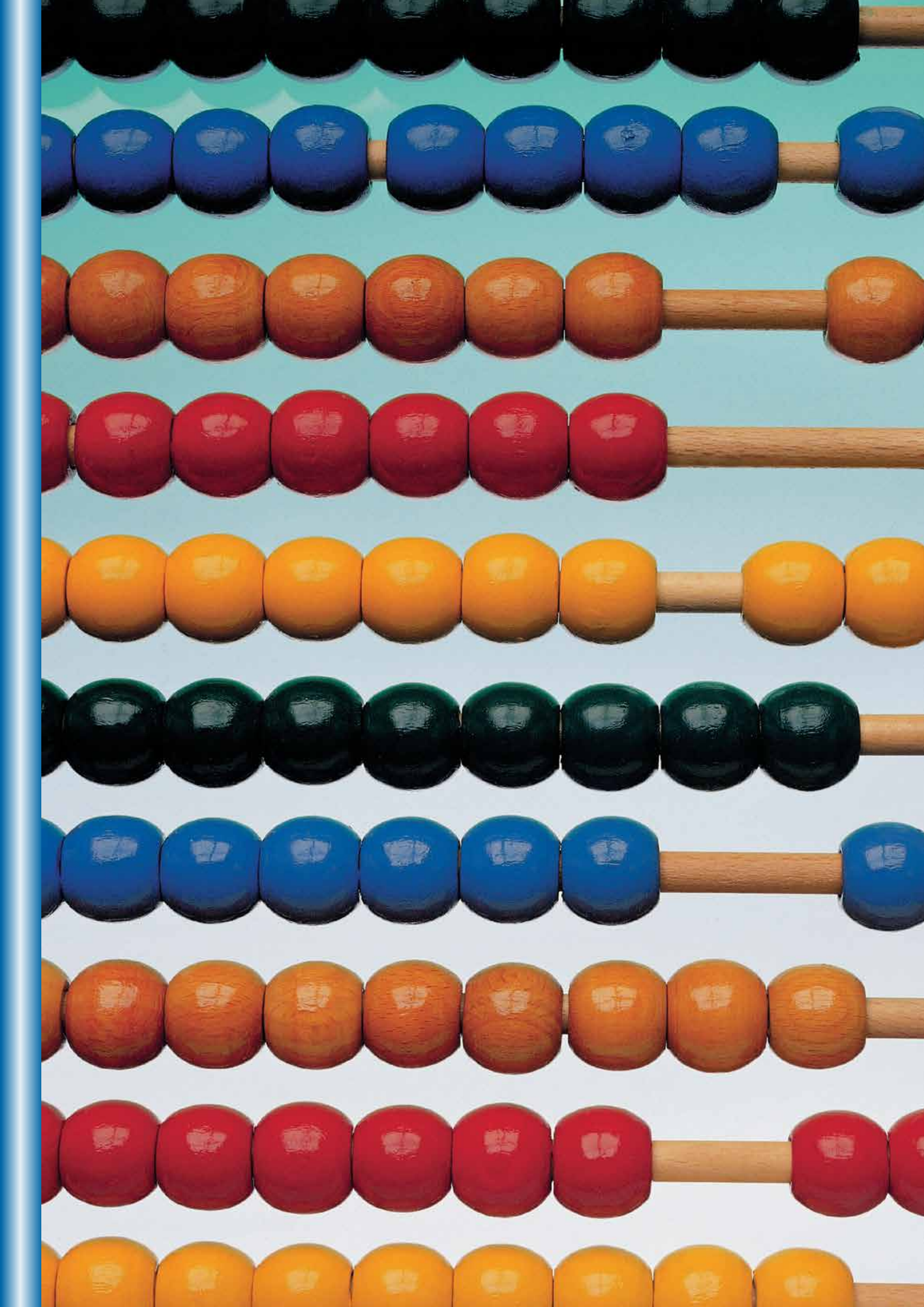

HPLC Columns YMC RP-Classics

Contents

YMC-Pack ODS-AQ	138-141
YMC-Pack ODS-A	142-143
YMC-Pack ODS-AM	144-145
YMC-Pack ODS-AL	146-147
YMC-Pack PolymerC18	148-149
YMCbasic	150-151
YMC-Pack C ₈ (Octyl)	152-153
YMC-Pack Ph (Phenyl)	154-155
YMC-Pack C ₄ (Butyl)	156-157
YMC-Pack TMS (C1)	158-159
YMC-Pack CN (Cyano)	160-161
Ordering Information.....	162-165

Introduction

HPLC Columns for Reversed Phase Chromatography

In order to succeed in HPLC, the choice of the optimal selectivity is essential to establish efficient separation conditions. The best suited packing material depends significantly on the characteristics of the separation conditions, which should be thoroughly considered.

For this purpose YMC offers a wide variety of selectivities applicable to HPLC from nano-scale analysis to large scale isolation. Within this chapter the world renowned YMC-Pack ODS-Series (YMC-Pack ODS-AQ, YMC-Pack ODS-A, YMC-Pack ODS-AM, YMC-Pack ODS-AL) and other phases are described.

YMC-Pack ODS-AQ

- “hydrophilic” C18
- balanced surface chemistry
- polar recognition
- metabolite recognition



YMC-Pack ODS-AQ	Specification	
Particle size / μm	3; 5	3; 5
Pore size / nm	12	20
Surface area / m^2g^{-1}	330	175
Carbon content / %	14	10
Recommended pH range	2.0 - 7.5	2.0 - 7.5

General

YMC-Pack ODS-AQ is a C18 reversed phase silica based HPLC packing material specifically designed for use in 100% aqueous eluents. As a result of the proprietary derivatisation process, YMC-Pack ODS-AQ exhibits a different selectivity to that of traditional C18 stationary phases. This difference in selectivity of YMC-Pack ODS-AQ can be used to advantage for HPLC separations, which are difficult to achieve with conventional C18 columns.

Selectivity Data

The proprietary YMC derivatisation process creates the different selectivity of YMC-Pack ODS-AQ, where:

1. The activity of acidic unreacted silanols is reduced, allowing moderately basic compounds to be eluted with little or no peak tailing.
2. The balanced hydrophilic/lipophilic nature of the YMC-Pack ODS-AQ stationary phase leads to strong retentions of polar sample solutes even in aqueous eluents.

These properties of YMC-Pack ODS-AQ are beneficial for separations of polar organic compounds, which tend not to be retained or are unresolved when conventional C18 columns are used.

Many conventional ODS packings lose their ability to retain polar compounds in these high aqueous content mobile phases as shown opposite. They appear less lipophilic with densely folded C18 chains. However, in similar mobile phases, YMC-Pack ODS-AQ maintains its brush-like C18 chain structure and its lipophilic properties and provides excellent retention of polar compounds.

Applications

YMC-Pack ODS-AQ is able to resolve compounds with minor differences in polarity from closely related chemical structures. As a result, YMC-Pack ODS-AQ is an excellent tool for the separation of drugs and corresponding metabolites, pesticides and degradation products, or peptides and protein digests etc. This capability of “polar recognition” opens up a broad application range for YMC-Pack ODS-AQ in life sciences and pharmacology.

Genuine linear scale-up from analytical to large scale separations is easily achievable with YMC products such as YMC-Pack ODS-AQ, where particle sizes from 3 to 50 μm are available in large lot sizes up to several hundred kilograms, if needed. This, together with the outstanding selectivity of YMC-Pack ODS-AQ, make it an essential tool to enhance the productivity of large scale chromatographic processes.

YMC-Pack ODS-AQ

Comparison of ODS-AQ vs. Conventional ODS

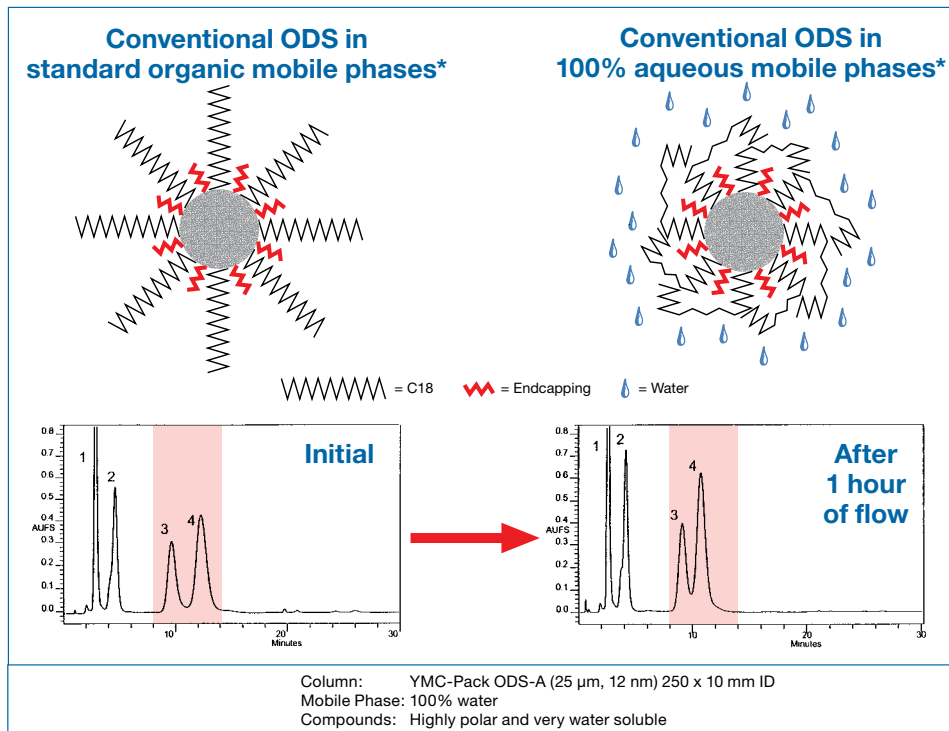

Conventional ODS-Column:

Retention time loss!

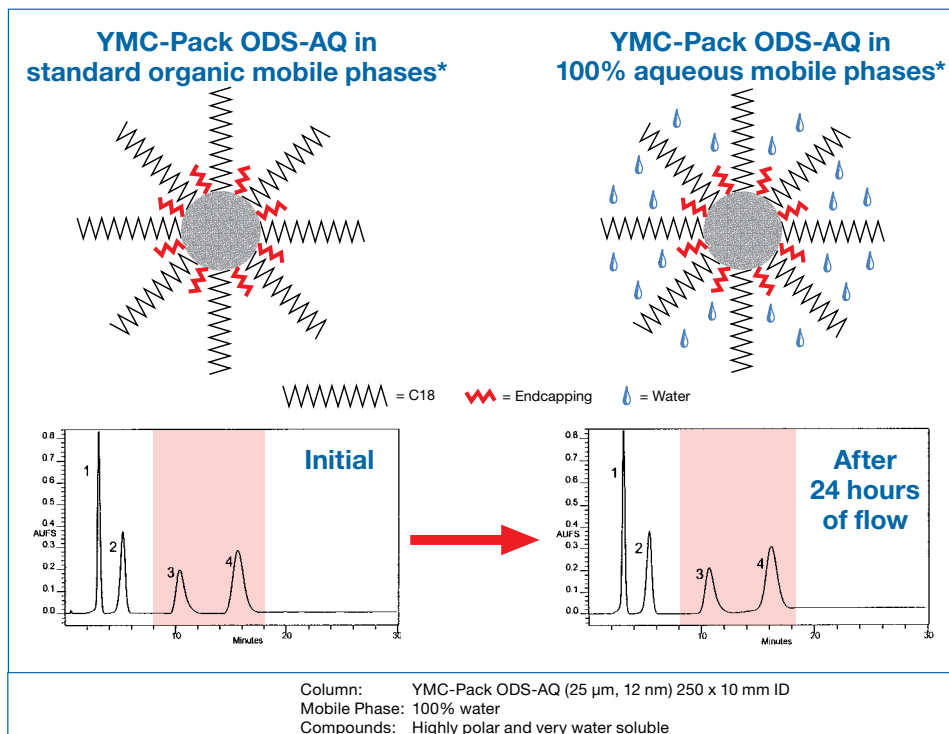

YMC-Pack ODS-AQ:

Stable retention times!

YMC-Pack ODS-AQ

Exceptional performance for the separation of polar compounds*

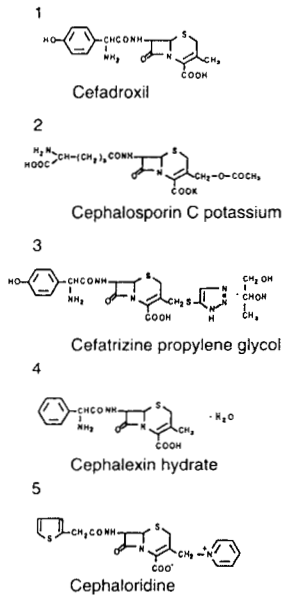
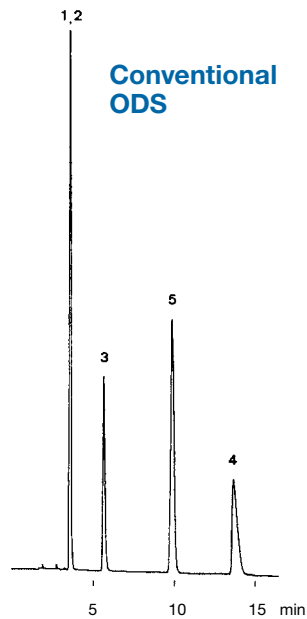

YMC-Pack ODS-AQ

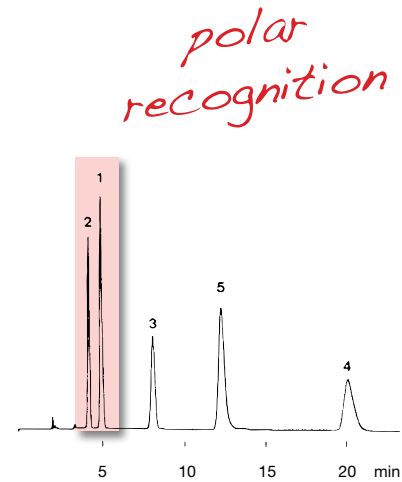

Cephalosporin antibiotics

Column: YMC-Pack ODS-AM (5 μ m, 12 nm) 150 x 4.6 mm ID
Part No.: AM12S05-1546WT
Eluent: methanol / water / acetic acid (10/85/5)
Flow: 1.0 mL/min
Detection: UV at 260 nm, 0.16 AUFS
Temperature: 37 °C

Cephalosporin antibiotics

Column: YMC-Pack ODS-AQ (5 μ m, 12 nm) 150 x 4.6 mm ID
Part No.: AQ12S05-1546WT
Eluent: methanol / water / acetic acid (10/85/5)
Flow: 1.0 mL/min
Detection: UV at 260 nm, 0.16 AUFS
Temperature: 37 °C

Strong retention in aqueous eluents*

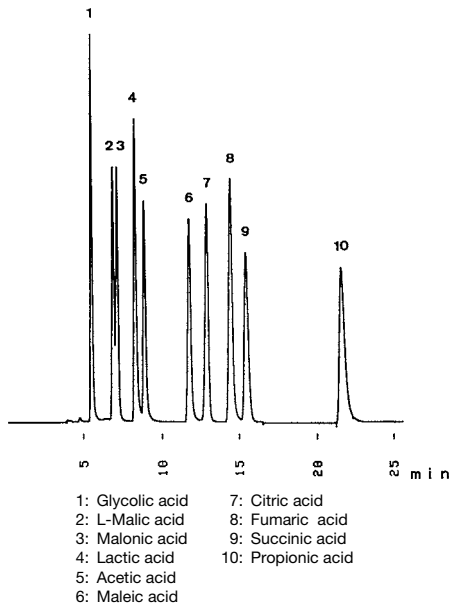

Crude drugs

Column: YMC-Pack ODS-AQ (5 μ m, 12 nm) 250 x 4.6 mm ID
Part No.: AQ12S05-2546WT
Eluent: 20 mM H_3PO_4 - NaH_2PO_4 (pH 2.8)
Flow: 0.7 mL/min
Detection: UV at 220 nm, 0.08 AUFS
Temperature: 30 °C
Injection: 10 μ L (0.007 ~ 1.8 mg/mL)

No need for ion pair reagents*

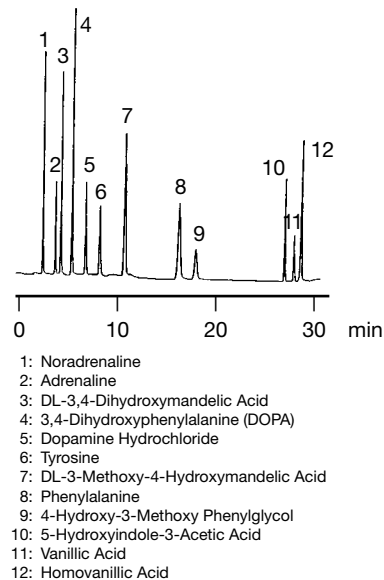

Catecholamines

Column: YMC-Pack ODS-AQ (5 μ m, 12 nm) 250 x 4.6 mm ID
Part No.: AQ12S05-2546WT
Eluent: A: phosphate buffer (100 mM, pH 3.0) B: acetonitrile
Gradient: 99% A (0-20 min), 85% A (20-25 min)
Flow: 1.5 mL/min
Detection: UV at 210 nm
Temperature: Room temperature

YMC-Pack ODS-AQ

Separation of biomolecules*

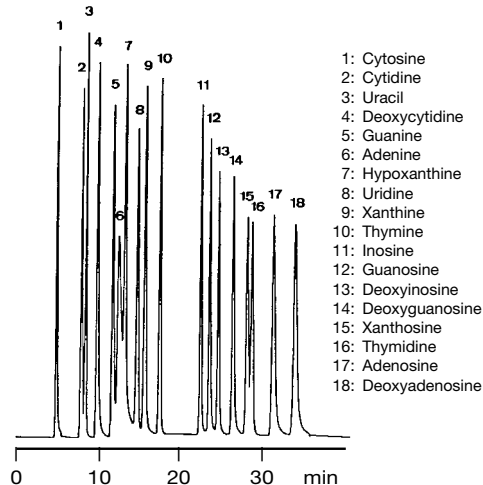

Nucleosides

Column: YMC-Pack ODS-AQ (5µm, 12 nm) 250 x 4.6 mm ID
 Part No.: AQ12S05-2546WT
 Eluent: A = 20 mM CH₃COOH-CH₃COONH₄ (pH 3.5)
 B = 20 mM CH₃COOH-CH₃COONH₄ (pH 3.5) / methanol = 90/10 (v/v)
 Gradient: 30% B (0-5 min), 30-100% B (5-13 min, linear), 100% B (13-40 min)
 Flow: 0.7 mL/min
 Detection: UV at 260 nm
 Temperature: 30 °C

Excellent choice for a broad chromatographic application range*

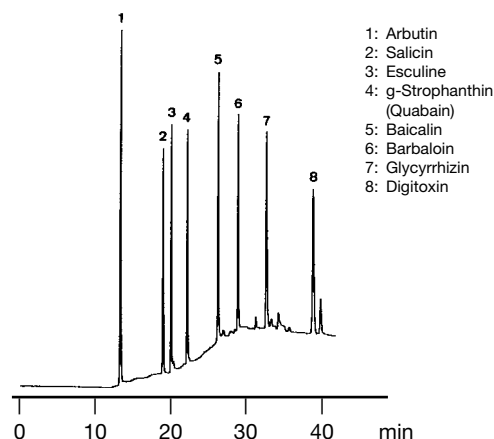

Crude drugs

Column: YMC-Pack ODS-AQ (5µm, 12 nm) 250 x 4.6 mm ID
 Part No.: AQ12S05-2546WT
 Eluent: A: methanol / NH₄H₂PO₄ (20 mM) = 5/95
 B: methanol / NH₄H₂PO₄ (20 mM) = 80/20
 Gradient: 0-100% B (0-20 min, linear), 100% B (20-40 min)
 Flow: 0.6 mL/min
 Detection: UV at 250 nm
 Temperature: 30 °C

Comparison of YMC-Pack ODS-AQ with competitive products

Since 1985, YMC-Pack ODS-AQ has consistently increased its popularity due to its novel selectivity pattern towards polar compounds and its ability to withstand 100% aqueous conditions. Today, more than 30 (!) years later, many new analytical and preparative methods are still being developed on YMC-Pack ODS-AQ chemistry despite various AQ-type products being introduced by our competitors; phases with supposedly "identical" selectivity or with exotic bonding techniques designed to generate performance characteristics similar to those of YMC-Pack ODS-AQ. However, genuine YMC-Pack ODS-AQ still represents today a fully competitive state-of-the-art high performance stationary phase, despite the complementary YMC innovations, namely YMC-Triart C18 and Hydrosphere, C18 as potential in-house competitors.

Tryptic digest of BSA

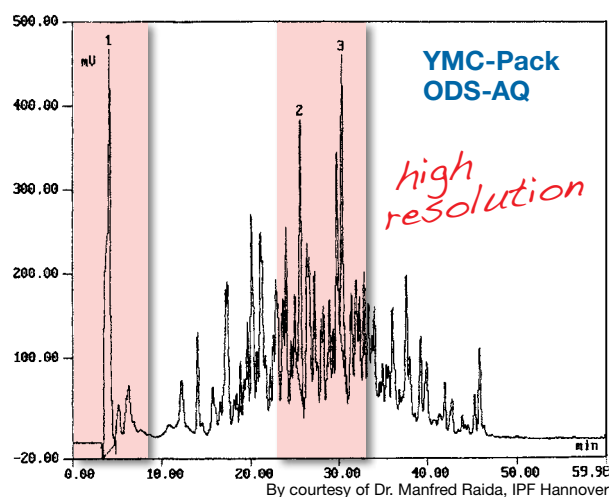
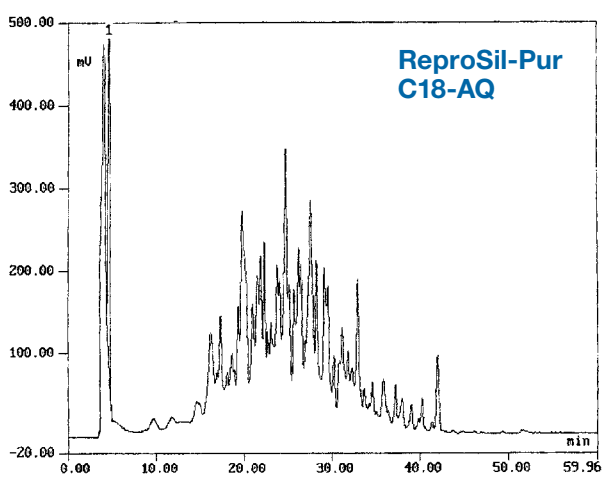

By courtesy of Dr. Manfred Raida, IPF Hannover

For more applications please refer to our "Application Data Collections" or contact us directly.

Column care

The recommended pH range for YMC-Pack ODS-AQ is 2.0 - 7.5 in up to 100% aqueous systems and a maximum of 50 °C. Remove acid and buffer salts before storage. Store the column in methanol / water = 70/30. Clogged inlet frits often can be cleaned by changing the flow direction.

For detailed information please refer to the "Column Care and Use Instructions" which can be downloaded from www.ymc.de.

YMC-Pack ODS-A

- fully endcapped C18 material
- highly versatile ODS phase
- for polar to moderately nonpolar pharmaceuticals, organic chemicals, biologicals and natural products



YMC-Pack ODS-A	Specification		
Particle Size / μm	3; 5	3; 5	3; 5
Pore Size / nm	12	20	30
Surface area / m^2g^{-1}	330	175	100
Carbon content / %	17	12	7
Recommended pH range	2.0 - 7.5	2.0 - 7.5	2.0 - 7.5

General

YMC-Pack ODS-A, YMC's classical reversed phase packing material, is renowned worldwide because of its unique performance and reproducibility. Due to the high quality, YMC-Pack ODS-A is widely used for the validation of analytical HPLC methods and for long-term reproducible preparative HPLC processes.

Properties

The production of the base silica for YMC-Pack ODS-A and its subsequent derivatisation are performed in large bulk batches. Exhaustive endcapping reduces reliably the activity of silanol groups and minimises nonspecific secondary interaction.

In addition to standard methods, like determination of adsorption isotherms, particle size distribution and carbon content (see table above), YMC uses an extensive range of analytical methods to ensure constant and reproducible selectivity of the reversed phase packings.

The base of YMC-Pack ODS-A is YMC's high purity silica. This premium silica contains only very low levels of metal contaminants and so prevents significant tailing of sample molecules such as 8-hydroxyquinoline or acetyl acetone, which easily form coordinating complexes with metal ions on the silica surface. As coordinating functional groups are frequent structural components in pharmaceutical compounds, high purity packings such as YMC-Pack ODS-A are needed for reproducible separation of these compounds without secondary retention or tailing.

YMC-Pack ODS-A is also available in preparative particle sizes.

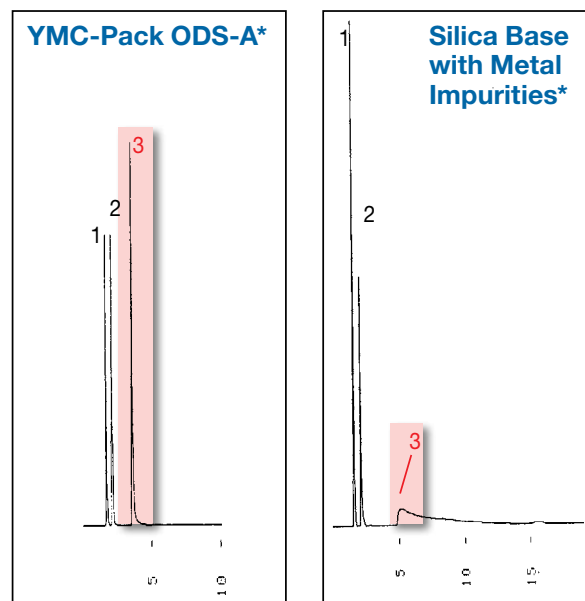

Column: YMC-Pack ODS-A (12 nm, 5 μm , 150 x 4.6 mm ID)
 Eluent: KH_2PO_4 (20 mM, pH 7.6) / methanol = 40/60
 Flow: 1.0 mL/min
 Detection: UV, 254 nm
 Temperature: 37 $^\circ\text{C}$
 Substances:
 1. Uracil
 2. Acetylacetone
 3. 8-Hydroxyquinoline

Coordinating compounds

YMC-Pack ODS-A

Applications

YMC-Pack ODS-A is frequently used for pharmaceutical, biochemical and environmental applications as well as for separations in the field of food technology.

YMC-Pack ODS-A is available in particle sizes from 3 to 50 μm . As the selectivity is identical throughout the whole range, these phases are ideal for scale-up from analytical to preparative process scale.

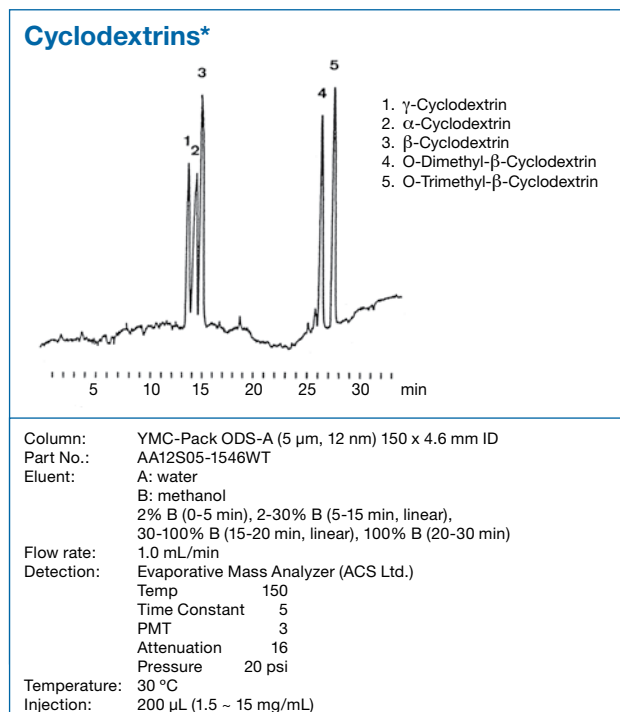
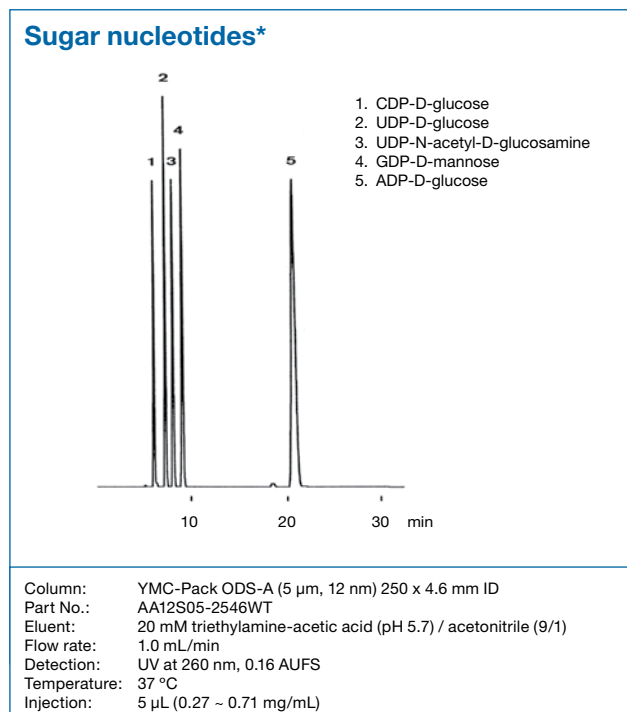
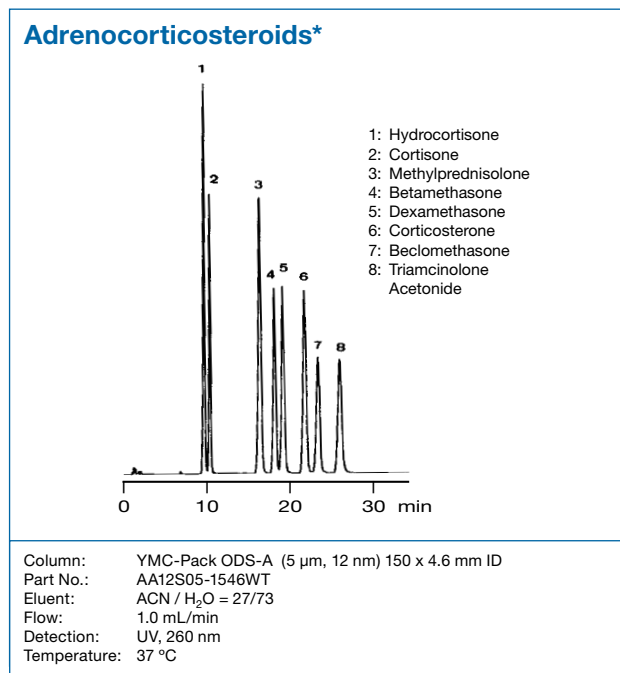
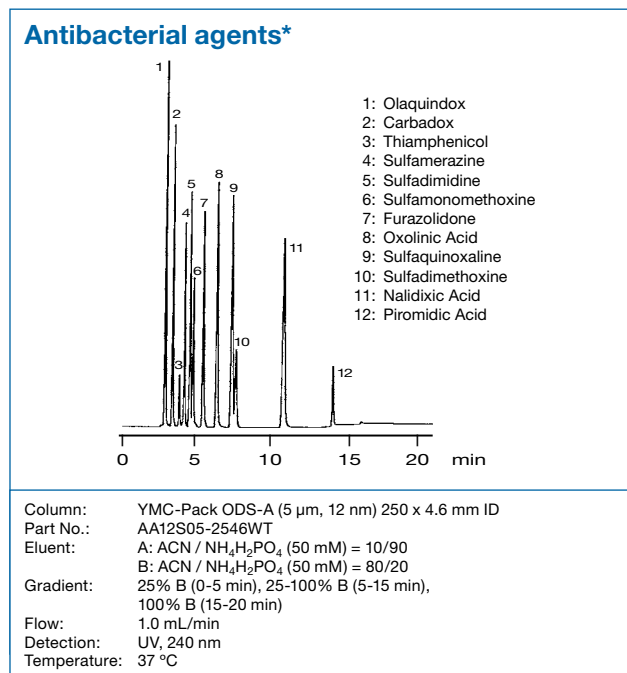

Column Care

The recommended pH range for using YMC-Pack ODS-A columns is 2.0-7.5. Remove acid and buffer salts before storage. Store the column in methanol/water = 50/50. If columns are affected by undesired contaminants or clogged inlet frits which cause back pressure increases, flush the column with THF in the opposite flow direction.

For detailed information please refer to the "Column Care and Use Instructions" which can be downloaded from www.ymc.de.

YMC-Pack ODS-AM

- high quality analytical C18
- tightly specified
- long term reproducibility
- for method validation
- for method registration



YMC-Pack ODS-AM	Specification
Particle Size / μm	3; 5
Pore Size / nm	12
Surface area / m^2g^{-1}	330
Carbon content / %	17
Recommended pH range	2.0 - 7.5

General

Validation and registration of analytical HPLC methods require the long term reproducibility of the entire analytical process. The high consistency in the quality of HPLC packings and columns plays a key role for validated HPLC analysis. Therefore, YMC created ODS-AM, a high quality reversed phase C18 HPLC packing material to meet the most stringent demands for validated analytical HPLC processes.

Properties

YMC-Pack ODS-AM is produced in large lots using high purity YMC silica as a base material and a multi stage synthesis process. For the derivatisation, monomeric bonding chemistry is applied followed by an extensive endcapping process to reduce the silanol activity.

The resulting YMC-Pack ODS-AM packing is extensively tested to ensure compliance with specifications set for very low variations in physicochemical properties.

In addition, YMC-Pack ODS-AM packings and columns have to pass numerous proprietary chromatographic tests to meet the narrow quality specification range with regard to:

- selectivity pattern
- column resolution
- absolute retention
- peak symmetry

YMC applies various tests to perform statistical quality control for reversed phase HPLC packings. The α -value test of methylparaben and 2,6-dimethylpyridine for instance, is very sensitive and is routinely used to monitor the retention and the selectivity properties of YMC-Pack ODS-AM.

Methylparaben is a moderately polar, inert compound. It is retained solely by a RP mechanism, with minimal secondary interactions with residual silanol groups. 2,6-dimethylpyridine, however, represents a lipophilic amine compound which has a high potential of unspecific interaction with unreacted acidic silanols. An increase in retention of 2,6-dimethylpyridine and hence lower α -values would indicate incomplete C18 bonding and/or ineffective endcapping. YMC specifies for ODS-AM that the statistical α -value of methylparaben and 2,6-dimethylpyridine be 2.77 +/- 0.20.

The rigorous quality control and the quality assurance system applied by YMC minimises the variation in retention and selectivity of YMC-Pack ODS-AM columns.

Due to the guaranteed long term reproducibility, YMC-Pack ODS-AM columns often are the final choice for establishing validated HPLC analysis.

Statistical Quality Control (α -value monitoring)

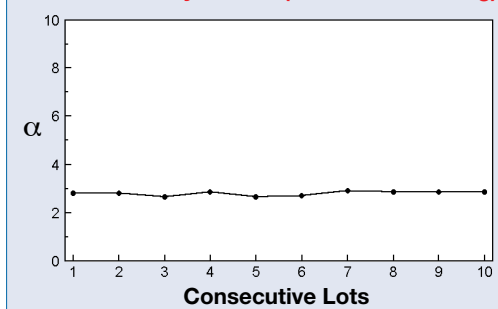

α : Methylparaben/2,6-Dimethylpyridine as reference

YMC-Pack ODS-AM

Applications

ODS-AM has an appropriate selectivity for polar to moderately nonpolar pharmaceuticals, organic intermediates, biological and natural products found in the chemical and pharmaceutical industry.

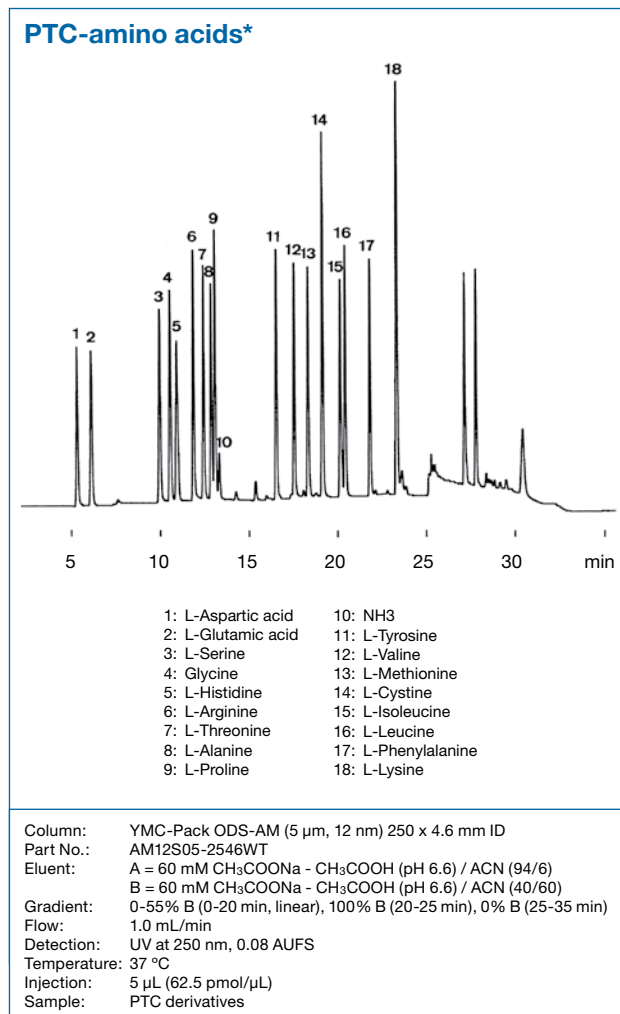
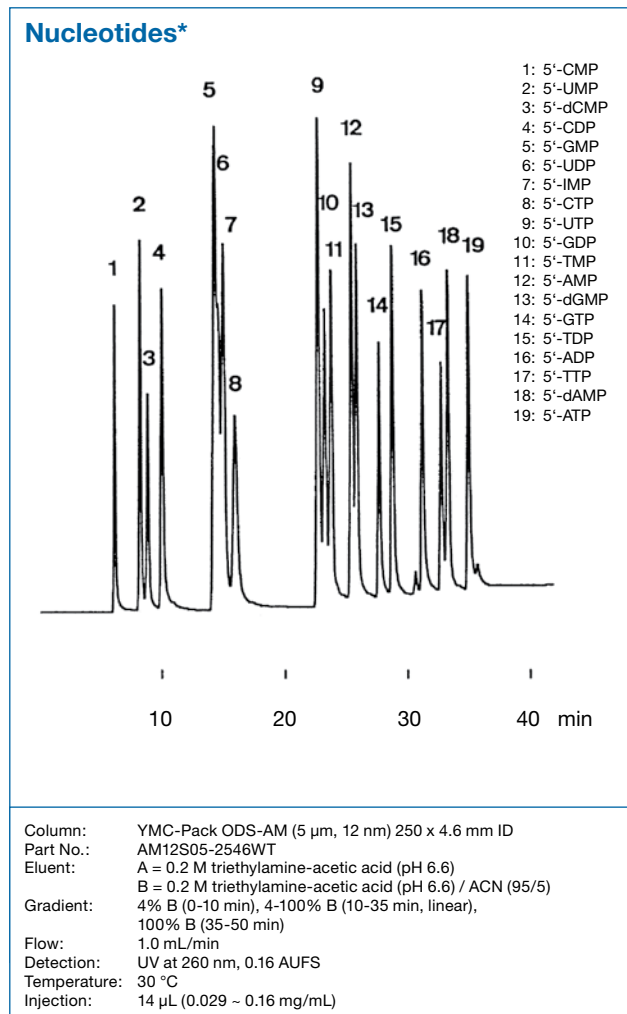

Column Care

The recommended pH range for using YMC-Pack ODS-AM columns is 2.0-7.5. Remove acid and buffer salts before storage. Store the column in methanol/water = 50/50. If columns are affected by undesired contaminants or clogged inlet frits which cause back pressure increases, flush the column with THF in the opposite flow direction.

For detailed information please refer to the "Column Care and Use Instructions" which can be downloaded from www.ymc.de.

YMC-Pack ODS-AL

- residual silanols for mixed-mode separations
- same high ligand density as other YMC ODS phases
- unique selectivity for polar compounds
- not endcapped



YMC-Pack ODS-AL	Specification
Particle Size / μm	3; 5
Pore Size / nm	12
Surface area / m^2g^{-1}	330
Carbon content / %	17
Recommended pH range	2.0 - 7.5

General

YMC-Pack ODS-AL uses not only hydrophobic interaction but also secondary interactions with reactive residual silanol groups to affect separation. This results in a different selectivity from conventional ODS columns. When ionic interactions are involved, it is preferable to use a buffer in the mobile phase to achieve reproducible separations.

Effects of silanol groups*

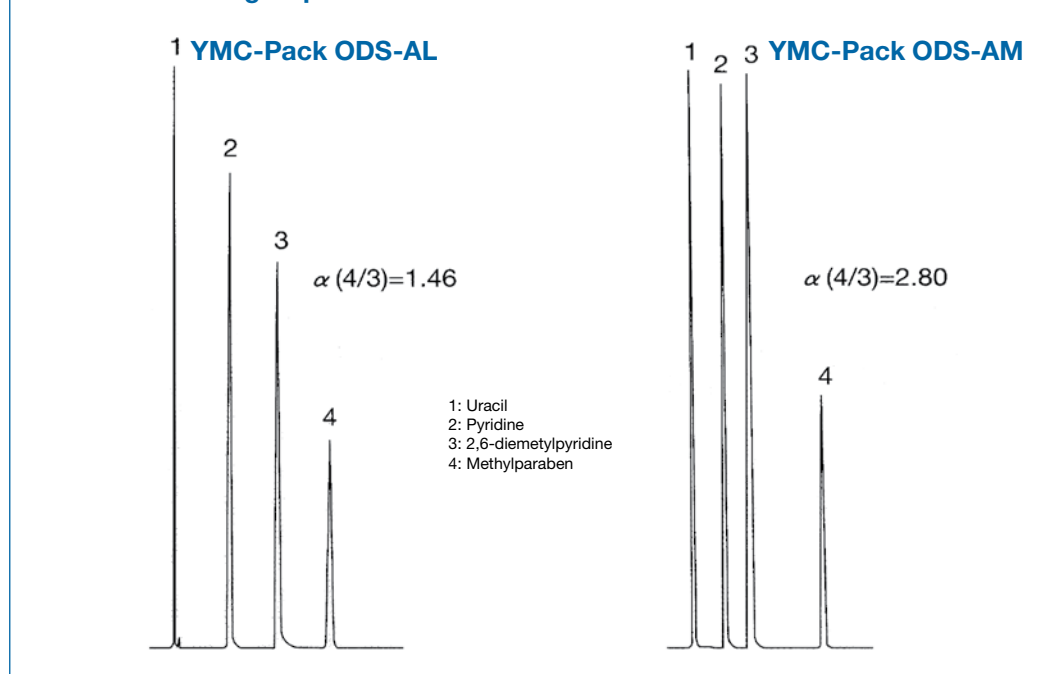

The separation factor (α) of internal standards methylparaben / 2,6-dimethylpyridine for YMC-Pack ODS-AL, which is not endcapped is different to that of YMC-Pack ODS-AM. Due to the residual silanol groups, YMC-Pack ODS-AL shows higher retention of pyridines.

YMC-Pack PolymerC18

- hydrophilic polymethacrylate support
- excellent reproducibility of C18 chemistry integral to polymer matrix
- no silanol or metal contaminants
- pH stable from pH 2 - 13
- compatible with all standard reversed phase solvents



YMC-Pack PolymerC18	Specification
Particle Size / μm	6
Pore Size / nm	proprietary
Surface area / m^2g^{-1}	n/a
Carbon content / %	10
Recommended pH range	2.0 - 13.0

General

YMC-Pack PolymerC18 is a reversed phase liquid chromatography packing which provides a broad range of solvent choices and a pH range from 2.0 - 13. YMC-Pack PolymerC18 is manufactured from a hydrophilic methacrylate polymer which is cross-linked with C18 ligand-containing reagents. YMC-Pack PolymerC18 offers a maximum application range: a wide variety of compounds such as organic acids, organic amines, peptides, pharmaceuticals and proteins can be separated using YMC-Pack PolymerC18.

Properties

YMC-Pack PolymerC18 is prepared from a hydrophilic methacrylate polymer bonded with a hydrophobic octadecylsilane reagent to make the C18 functionality an integral part of the polymeric structure. This gives a three-dimensional polymer matrix which is not based on a silica gel support.

As such, it has no residual silanols or metal impurities to interfere with the separation of basic organic compounds.

YMC-Pack PolymerC18 is compatible with all common reversed phase eluents such as water, methanol, acetonitrile and THF. Virtually all aqueous buffers and acid modifiers, such as TFA and phosphoric acid, as well as base modifiers such as sodium hydroxide and ammonium hydroxide can be used. Since it resists shrinking and swelling, YMC-Pack PolymerC18 can be used with eluents ranging in composition from 100% aqueous to 100% organic component.

In addition, YMC-Pack PolymerC18 can easily be sterilised by flushing with 0.1M NaOH in 20% acetonitrile/water.

The selectivity and retention of YMC-Pack PolymerC18 is similar to standard ODS phases, due to its hydrophobic bonding on a hydrophilic support. Consequently, its selectivity is closer to that of silica-based C18 supports than to styrene/DVB-based supports.

It should be noted that interactions between aromatic or conjugated systems and the methacrylate backbone provides slightly greater retention when compared to silica-based ODS columns, whereas highly aliphatic compounds show greater retention on silica-based ODS supports.

YMC-Pack PolymerC18 is also available in preparative particle sizes.

YMC-Pack PolymerC18

Applications

Peptides and proteins*

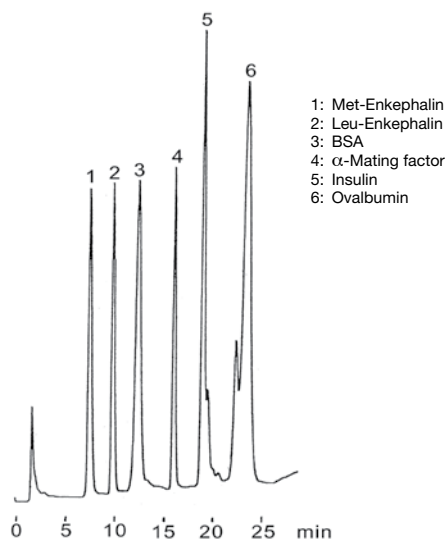

Column: YMC-Pack PolymerC18 150 x 4.6 mm ID
 Part No.: PC99S06-1546WT
 Eluent: A = acetonitrile / water / TFA (20/80/0.05)
 B = acetonitrile / water / TFA (45/55/0.05)
 0-100% B (0-30 min, linear)
 Flow: 1.0 mL/min
 Detection: UV at 220 nm, 0.32 AUFS
 Temperature: 30 °C
 Injection: 30 µL

Aminoalcohols*

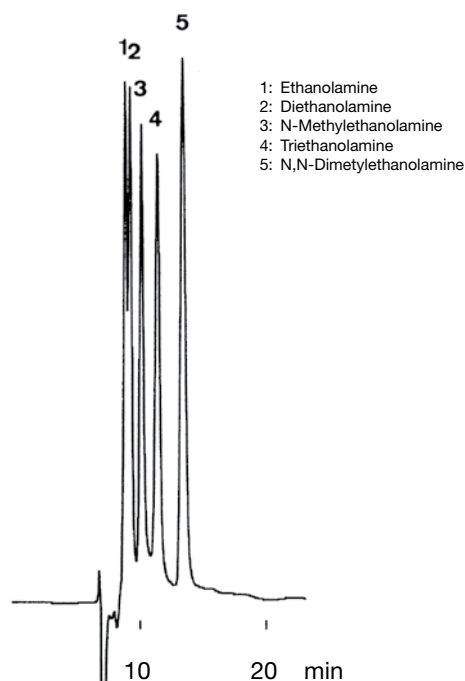

Column: YMC-Pack PolymerC18 250 x 6.0 mm ID
 Part No.: PC99S06-2506WT
 Eluent: 100 mM Na₂HPO₄ / 100 mM NaOH (60/40, pH 12.0)
 Flow: 0.6 mL/min
 Detection: UV at 215 nm, 0.32 AUFS
 Temperature: 20 °C
 Injection: 50 µL (0.2 ~ 3.0 mg/mL)

Organic acids*

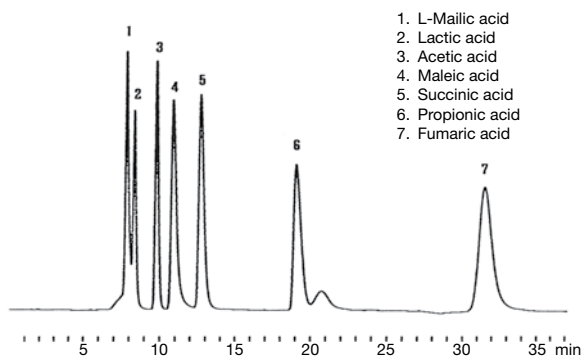

Column: YMC-Pack PolymerC18 250 x 4.6 mm ID
 Part No.: PC99S06-2546WT
 Eluent: 0.1% TFA
 Flow: 0.5 mL/min
 Detection: UV at 220 nm, 0.08 AUFS
 Temperature: 30 °C
 Injection: 10 µL (0.016 ~ 2.2 mg/mL)

Column care

YMC-Pack PolymerC18 is stable towards hydrolysis between pH 2.0-13.0. Remove acid and buffer salts before storage. Store the column in methanol / water = 70/30. If columns are affected by undesired contaminants or clogged inlet frits which cause back pressure increases, flush the column with THF in the opposite flow direction.

For detailed information please refer to the "Column Care and Use Instructions" which can be downloaded from www.ymc.de.

YMCbasic

- alternative bonding approach to reduce peak tailing of basic pharmaceuticals
- no need for ion pair reagents or amine modifiers
- complementing selectivity to C8 and C18 materials

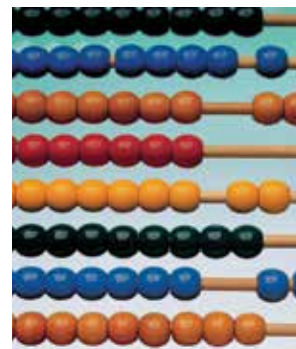

YMCbasic	Specification
Particle size / μm	3; 5
Pore size / nm	20
Surface area / m^2g^{-1}	175
Carbon content / %	7.0
Recommended pH range	2.0 - 7.5

General

The proprietary derivatisation procedure for YMCbasic allows YMC to produce a material with controlled surface coverage, which shows excellent lot-to-lot reproducibility as a result of closely monitoring both the production of the silica support and the bonding process.

The resulting YMCbasic material shows a different hydrophobicity to C8 or C18 phases as shown in the diagram on this page. Finally, it represents an interesting alternative to short chain selectivities.

Applications

The result is a phase with true reversed phase characteristics, high resolution and excellent peak symmetry for basic compounds without the need for ion pair reagents or amine modifiers (see separation of anilines using acetonitrile / water eluent). Unlike many base-deactivated phases,

YMCbasic is also suitable for separation of acidic compounds, showing slight retention of highly polar acid compounds such as maleate. YMCbasic provides a complementing selectivity seen with conventional C8 and C18 materials, but without peak tailing for basic compounds.

YMCbasic is also available in preparative particle sizes.

Hydrophobicity of YMCbasic versus YMC-Pack Octyl and YMC-Pack ODS-AM*

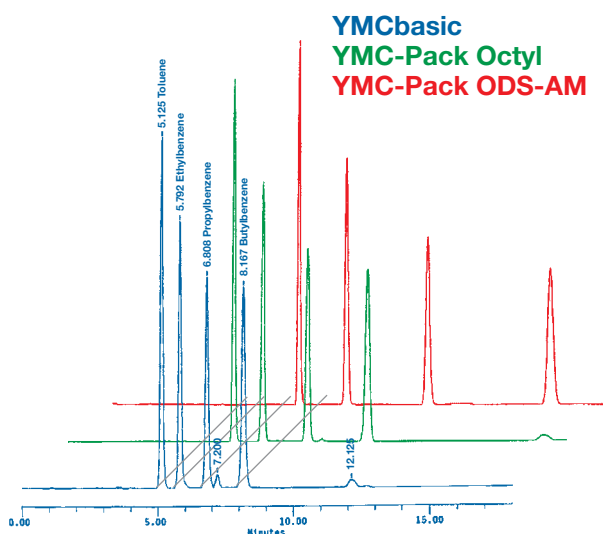

Column: 250 x 4.6 mm ID
 Eluent: acetonitrile / water (75/25)
 Flow: 1.0 mL/min
 Detection: UV at 254 nm

YMCbasic

Anilines and aromatic compounds*

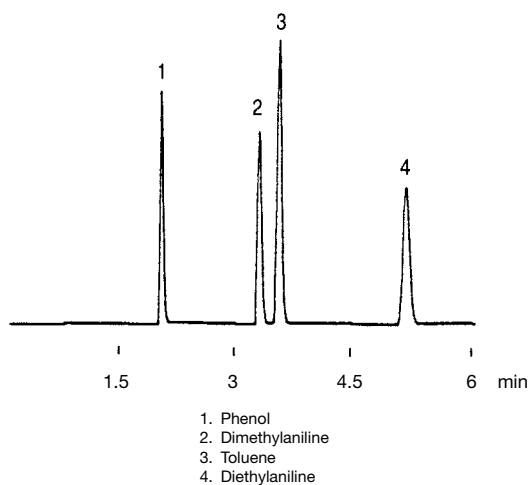

Column: YMCbasic (5 μ m) 250 x 4.6 mm ID
Part No.: BA99S05-2546WT
Eluent: acetonitrile / water (60/40)
Flow: 2.0 mL/min
Detection: UV at 254 nm

Cough/cold medicine*

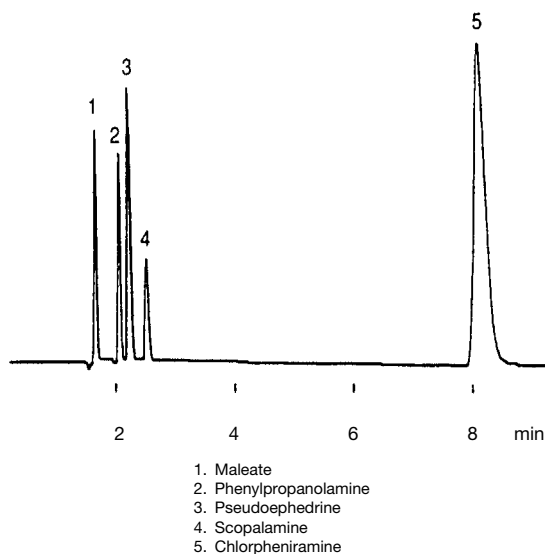

Column: YMCbasic (5 μ m) 250 x 4.6 mm ID
Part No.: BA99S05-2546WT
Eluent: acetonitrile / 0.05 mM KH_2PO_4 (pH 3.2) (15/85)
Flow: 2.0 mL/min
Detection: UV at 254 nm

Basic compounds*

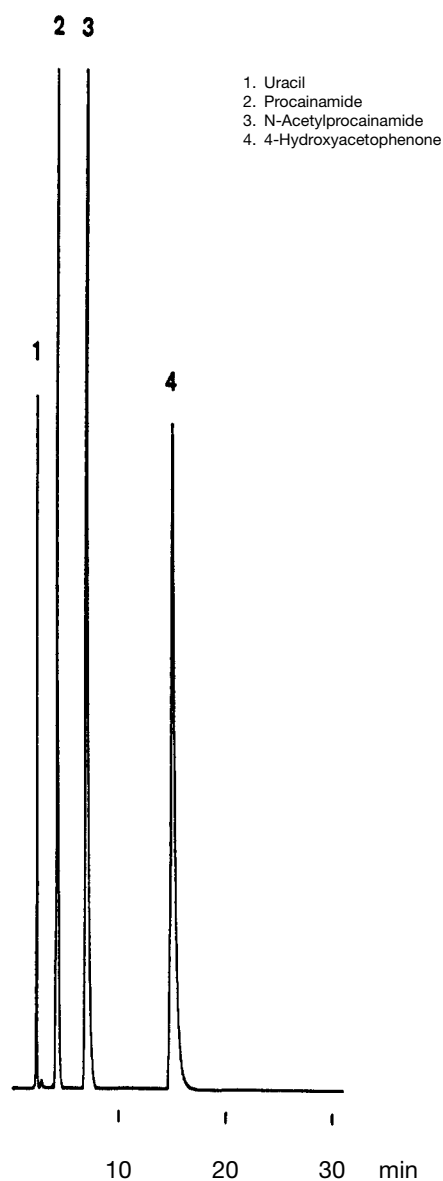

Column: YMCbasic (5 μ m) 150 x 4.6 mm ID
Part No.: BA99S05-1546WT
Eluent: 20 mM K_2HPO_4 - KH_2PO_4 (pH 6.9) / acetonitrile (92/8)
Flow: 1.0 mL/min
Detection: UV at 254 nm, 0.32 AUFS
Temperature: 37 $^\circ\text{C}$
Injection: 10 μL (30 - 300 $\mu\text{g/mL}$)

For more applications please refer to our "Application Data Collections" or contact us directly.

Column care

The recommend pH range for YMCbasic is 2.0 - 7.5. Remove acid and buffer salts before storage. Store the column in methanol/ water = 70/30. Clogged inlet frits often can be cleaned by changing the flow direction or replacement.

For detailed information please refer to the "Column Care and Use Instructions" which can be downloaded from www.ymc.de.

YMC-Pack C₈ (Octyl)

- alternative phase to C18 with moderate hydrophobicity
- fully endcapped, high coverage monomeric bonded chemistry
- ideal for method development and routine separations
- excellent retention for all types of organic molecules, especially peptides, proteins and pharmaceuticals

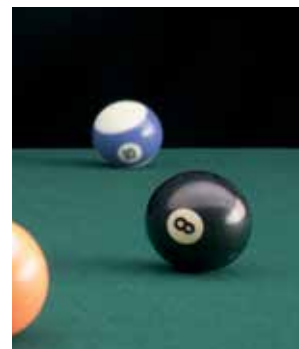

YMC-Pack C ₈	Specification		
Particle Size / μm	3; 5	3; 5	5
Pore Size / nm	12	20	30
Surface area / m^2g^{-1}	330	175	100
Carbon content / %	10	7	4
Recommended pH range	2.0 - 7.5	2.0 - 7.5	2.0 - 7.5

General

YMC-Pack C₈ is one of YMC's most commonly used bonded phases and an excellent alternative to C18 selectivities. Due to its moderate hydrophobicity, retention times tend to be shorter than those for ODS phases. YMC-Pack C₈ is suitable for a wide range of sample types including pharmaceuticals and biologicals with a relatively high hydrophobicity.

Properties

YMC-Pack C₈ is prepared by exhaustive bonding of a monomeric octylsilane to totally spherical and porous silica gel. The bonded phase is then treated with an exhaustive endcapping process to ensure a high surface coverage leading to a moderate 10% carbon loading on the standard 12 nm pore material. Compared to C18 phases, retention times for hydrophobic molecules will be shorter on C8 material due to the reduced carbon load.

YMC-Pack C₈ is ideally suited for the separation of many compounds that are too strongly retained on C18 phases or which require greater retention than provided by C4 materials. It is one of the most versatile reversed phase materials and should be considered for the development of new methods.

Available in three porosities, YMC-Pack C₈ material will separate many classes of compounds including pharmaceuticals, organic chemicals, peptides, protein and other biological molecules. For preparative applications, choose the smallest pore size which provides adequate retention and resolution. This is because sample loading is generally proportional to surface area. Smaller porosity media provide greater surface area and hence greater loadability.

YMC-Pack C₈ (Octyl) is also available in preparative particle sizes.

Column care

YMC-Pack C₈ (Octyl) is stable towards hydrolysis between pH 2.0-7.5. Remove acid and buffer salts before storage. Store the column in methanol / water = 70/30. If columns are affected by undesired contaminants or clogged inlet frits which cause back pressure increases, flush the column with THF in the opposite flow direction. For detailed information please refer to the "Column Care and Use Instructions" which can be downloaded from www.ymc.de.

YMC-Pack C₈ (Octyl)

Applications

Estrogens and progestins*

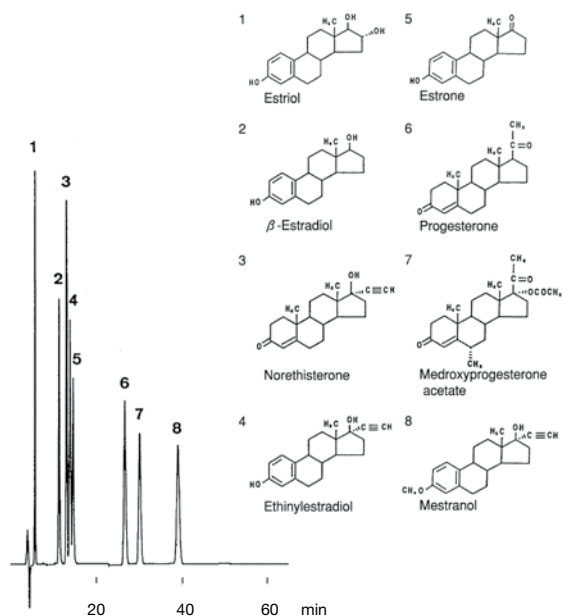

Column: YMC-Pack C₈ (Octyl) (5 μm, 12 nm) 250 x 4.6 mm ID
 Part No.: OC12S05-2546WT
 Eluent: acetonitrile / THF / water (46/4/50)
 Flow: 0.7 mL/min
 Detection: UV at 230 nm, 0.16 AUFS
 Temperature: 30 °C
 Injection: 7 μL (0.1 mg/mL)

Nicotinic acid analogues*

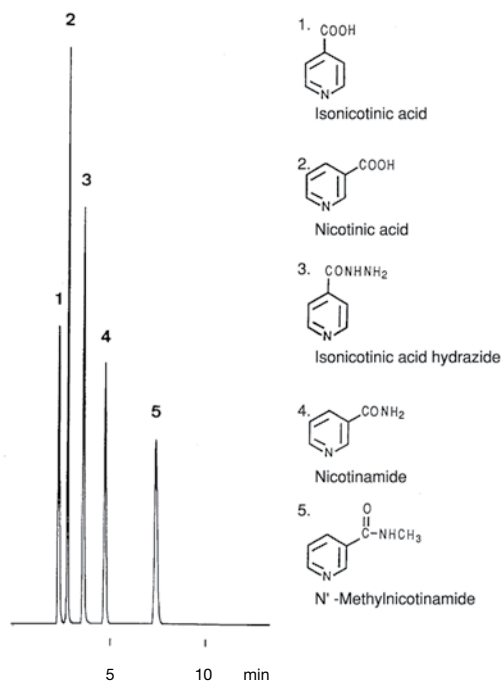

Column: YMC-Pack C₈ (Octyl) (5 μm, 12 nm) 150 x 4.6 mm ID
 Part No.: OC12S05-1546WT
 Eluent: acetonitrile / 20 mM KH₂PO₄ (5/95)
 Flow: 1.0 mL/min
 Detection: UV at 260 nm, 0.64 AUFS
 Temperature: 30 °C
 Injection: 13 μL (0.2 mg/mL)

Resorcylic acid isomers*

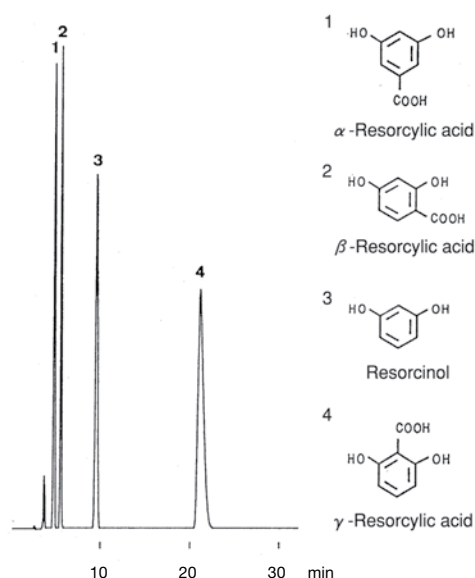

Column: YMC-Pack C₈ (Octyl) (5 μm, 12 nm) 150 x 4.6 mm ID
 Part No.: OC12S05-1546WT
 Eluent: methanol / 100 mM KH₂PO₄ (10/90)
 Flow: 0.8 mL/min
 Detection: UV at 285 nm, 0.16 AUFS
 Temperature: 37 °C
 Injection: 10 μL (0.05 - 0.4 mg/mL)

YMC-Pack Ph (Phenyl)

- fully endcapped, monomeric phenyl phase directly bonded
- unique selectivity due to π - π interactions
- preferential retention of aromatic compounds
- alternative selectivity to C18, C8 or C4 bonded phases for the analysis of peptides and other biomolecules



YMC-Pack Ph	Specification	
Particle Size / μm	3; 5	5
Pore Size / nm	12	30
Surface area / m^2g^{-1}	330	100
Carbon content / %	9	3
Recommended pH range	2.0 - 7.5	2.0 - 7.5

General

YMC-Pack Ph (Phenyl) is a high density bonded phase (9% carbon load on 12 nm silica) which is fully endcapped. This results in a superior bonded phase with proven performance and exceptional lifetime for a phenyl reversed phase column.

Properties

YMC-Pack Ph (Phenyl) provides a unique selectivity when compared to aliphatic straight chain reversed phases such as C18, C8 or C4. The π -electrons of the phenyl groups can interact with aromatic residues of an analyte molecule in addition to hydrophobic interactions to increase retention relative to non-aromatic species.

Phenyl phases are convenient for the separation of aromatic compounds and also provide a useful alternative to C18 or C4 phases for the separation of peptides and proteins on both small pore (12 nm) and wide pore (30 nm) materials. Retention is decreased on wide pore phenyl phases relative to 12 nm phenyl material due to the lower surface area of the wide pore material.

YMC-Pack Ph (Phenyl) is also available in preparative particle sizes.

YMC-Pack Ph (Phenyl)

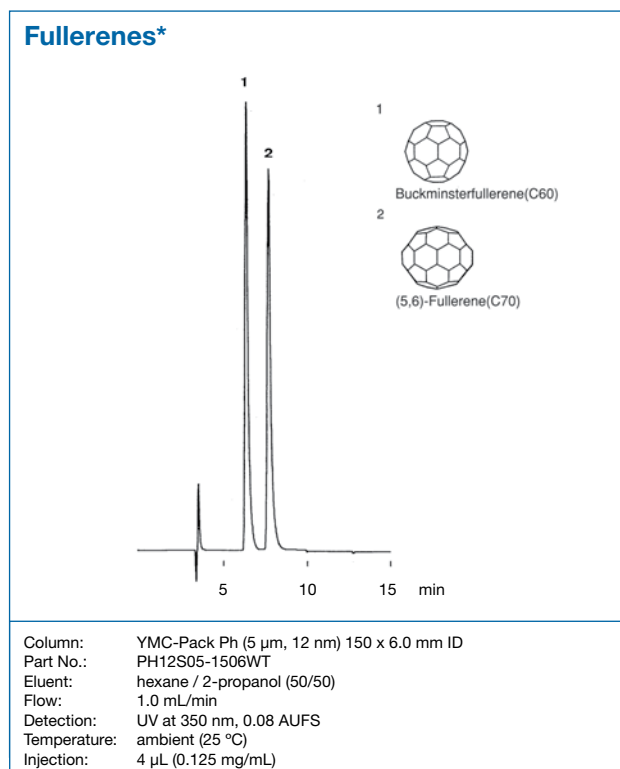
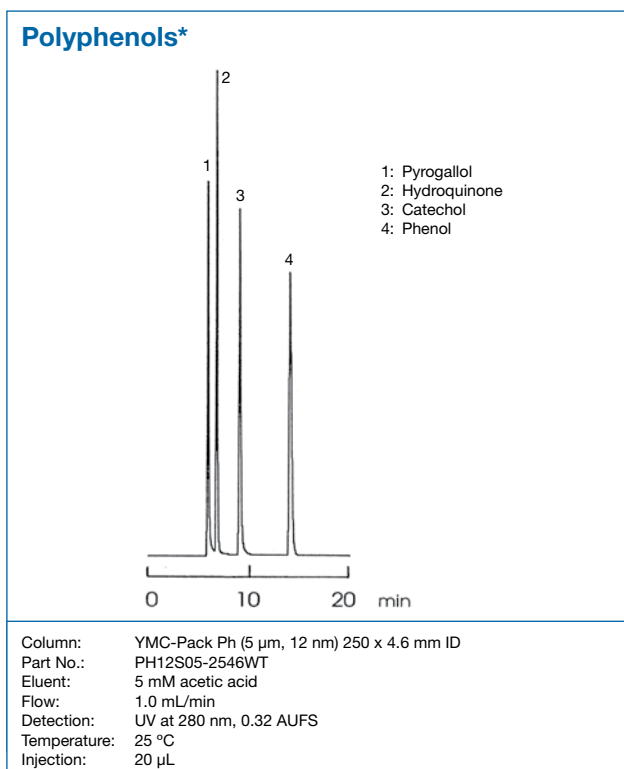
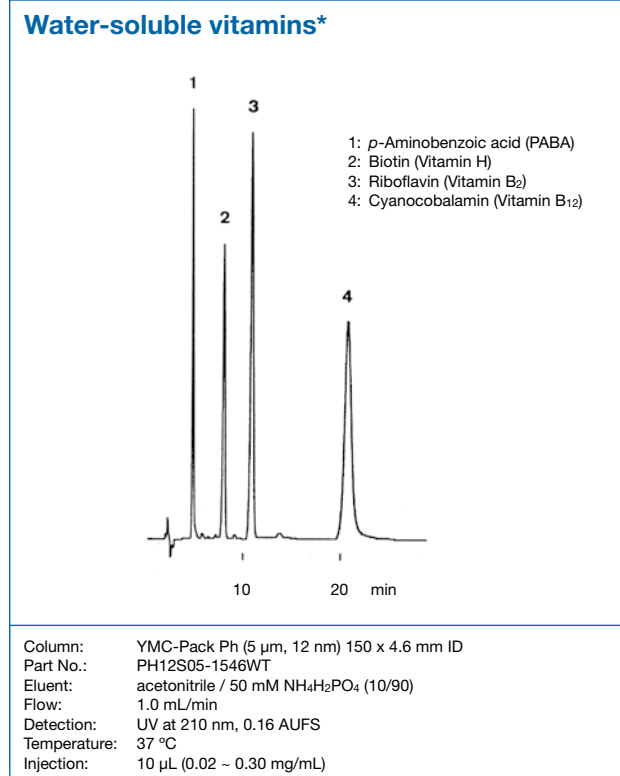
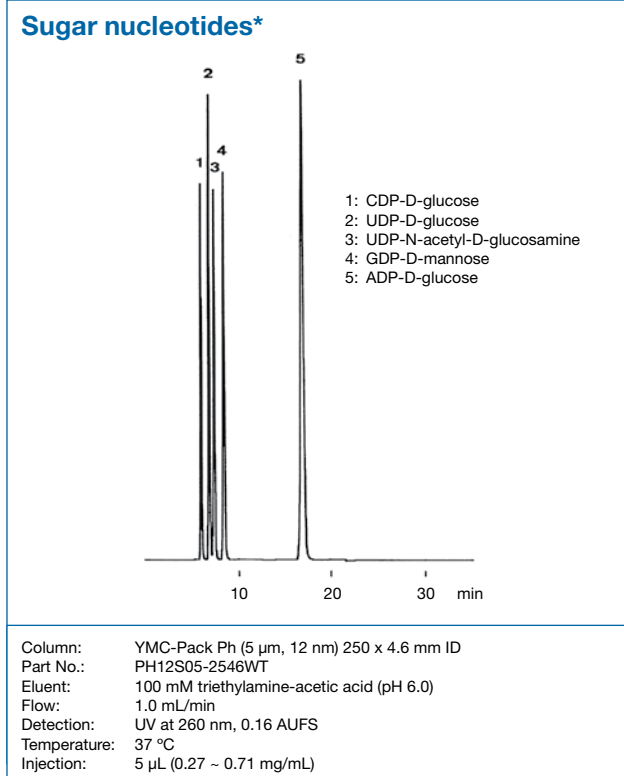

Column care

YMC-Pack Ph (Phenyl) is stable towards hydrolysis between pH 2.0-7.5. Remove acid and buffer salts before storage. Store the column in methanol / water = 70/30. If columns are affected by undesired contaminants or clogged inlet frits which cause back pressure increases, flush the column with THF in the opposite flow direction.

For detailed information please refer to the "Column Care and Use Instructions" which can be downloaded from www.ymc.de.

YMC-Pack C₄ (Butyl)

- low hydrophobicity material
- high coverage monomeric bonded chemistry
- ideally suited for separation of biological materials



YMC-Pack C ₄	Specification		
Particle Size / μm	3; 5	3; 5	3; 5
Pore Size / nm	12	20	30
Surface area / m^2g^{-1}	330	175	100
Carbon content / %	7	5	3
Recommended pH range	2.0 - 7.5	2.0 - 7.5	2.0 - 7.5

General

Due to shorter alkyl chains YMC-Pack C₄ has a lower hydrophobicity than both C18 and C8 phases. Therefore retention times of non-polar samples tend to be shorter on YMC-Pack C₄, making it an ideal choice for faster separations.

Properties

YMC-Pack C₄ phases are less hydrophobic and generally require more aqueous buffer than C8 or C18 phases. When compared to C8 or C18 packings using the same eluent, YMC-Pack C₄ shows significantly shorter retention times for nonpolar compounds. Retention of polar compounds, however, is not significantly affected. Therefore, mixtures with a wide range of component polarity are best separated by YMC-Pack C₄. This is because the butyl bonded phase gives shorter retention times while still maintaining high resolution when compared to longer chain bonded chemistries.

Proteins (MW 66,000 – 96,000)*

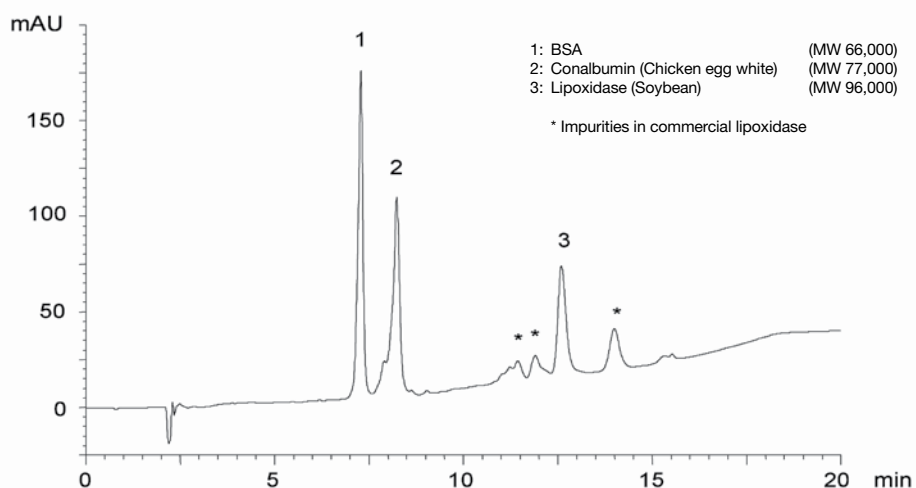

Column: YMC-Pack C₄ (5 μm , 30 nm) 150 x 4.6 mm ID
 Eluent: A = water / TFA (100/0.1)
 B = acetonitrile / 2-propanol / TFA (50/50/0.1); 30-75% B (0-15 min), 75% B (15-20 min)
 Flow: 1.0 mL/min
 Detection: UV at 220 nm
 Temperature: 37 °C
 Injection: 10 μL (0.25 ~ 1.0 mg/mL)

YMC-Pack C₄ (Butyl)

2,4-Dinitrophenylhydrazones of aldehydes and ketones*

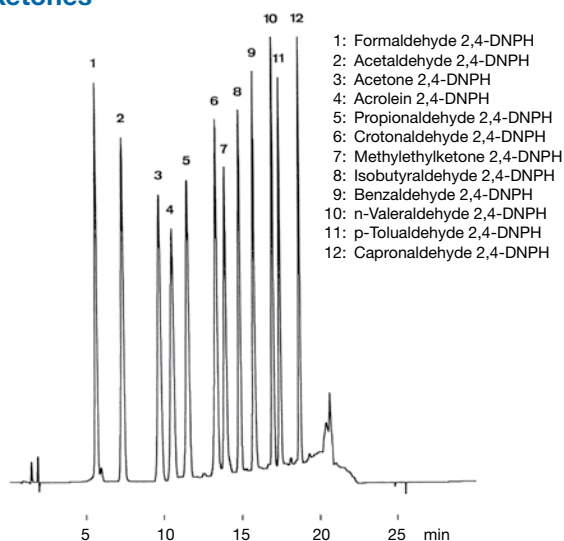

Column: YMC-Pack C₄ (5 μm, 12 nm) 150 x 4.6 mm ID
Part No.: BU12S05-1546WT
Eluent: A = tetrahydrofuran / water (10/90)
B = acetonitrile; 35% B (0-7 min), 35-65% B (7-18 min, linear),
100% B (18-19 min), 35% B (19-35 min)
Flow: 1.5 mL/min
Detection: UV at 360 nm, 0.01 AUFS
Temperature: 30 °C
Injection: 11 μL (0.0025 mg/mL)

Anti-human immunodeficiency virus (HIV) agents*

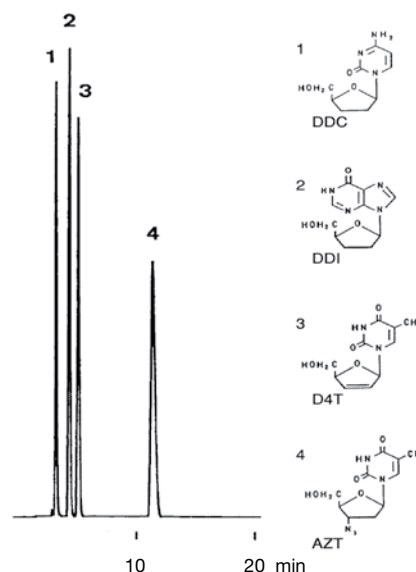

Column: YMC-Pack C₄ (5 μm, 12 nm) 150 x 4.6 mm ID
Part No.: BU12S05-1546WT
Eluent: methanol / 10 mM KH₂PO₄ (10/60)
Flow: 1.0 mL/min
Detection: UV at 254 nm, 0.16 AUFS
Temperature: 37 °C
Injection: 7 μL (0.125 mg/mL)

Proteins*

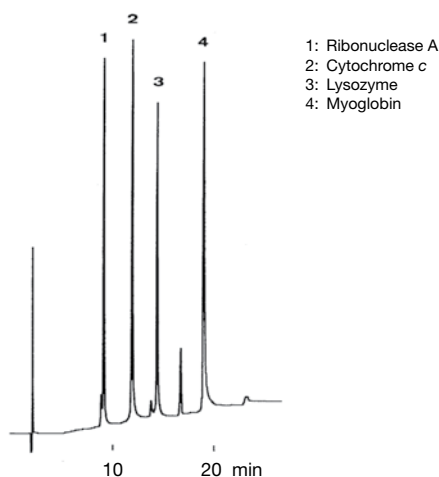

Column: YMC-Pack C₄ (5 μm, 30 nm) 150 x 4.6 mm ID
Part No.: BU30S05-1546WT
Eluent: A) acetonitrile / water / TFA (5/95/0.1)
B) acetonitrile / water / TFA (60/40/0.1)
Flow: 1.0 mL/min
Detection: UV at 220 nm, 0.32 AUFS
Temperature: 37 °C
Injection: 16 μL (0.16 ~ 0.33 mg/mL)

Water-soluble vitamins*

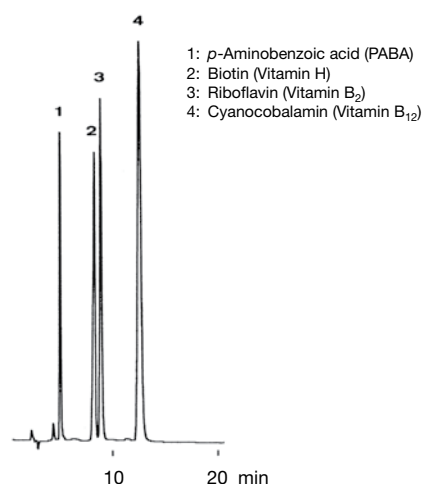

Column: YMC-Pack C₄ (5 μm, 12 nm) 150 x 4.6 mm ID
Part No.: BU12S05-1546WT
Eluent: acetonitrile / 50 mM NH₄H₂PO₄ (10/90)
Flow: 1.0 mL/min
Detection: UV at 210 nm, 0.16 AUFS
Temperature: 37 °C
Injection: 10 μL (0.02 ~ 0.30 mg/mL)

Column care

YMC-Pack C₄ is stable towards hydrolysis between pH 2.0-7.5. Remove acid and buffer salts before storage. Store the column in methanol / water = 70/30. If columns are affected by undesired contaminants or clogged inlet frits which cause back pressure increases, flush the column with THF in the opposite flow direction.

For detailed information please refer to the "Column Care and Use Instructions" which can be downloaded from www.ymc.de.

YMC-Pack TMS (C1)

- stationary phase with the lowest hydrophobicity among reversed phase packing materials
- intermediate polarity between normal phase silica and other alkyl bonded reversed phases
- for fast separations of highly hydrophobic compounds
- alternative to C18 for the separation of hydrophilic compounds



YMC-Pack TMS	Specification
Particle Size / μm	3; 5
Pore Size / nm	12
Surface area / m^2g^{-1}	330
Carbon content / %	4
Recommended pH range	2.0 - 7.5

General

YMC-Pack C1 (TMS) is a bonded phase suitable for samples that exhibit strong retention characteristics and are difficult or impossible to separate on conventional reversed phase or normal phase columns.

Properties

YMC-Pack TMS (C1) is bonded with trimethylmonochlorosilane to create a phase with intermediate polarity for separation of extremely hydrophobic compounds using conventional reversed phase solvents and of highly polar compounds using normal phase solvents.

The chemistry of YMC-Pack TMS (C1) is also well-suited for the analysis of multifunctional compounds. Selectivity characteristics of a C1 bonded phase can be unique, and samples must be tested to determine the suitability of the phase.

YMC-Pack TMS (C1) is also available in preparative particle sizes.

YMC-Pack TMS (C1)

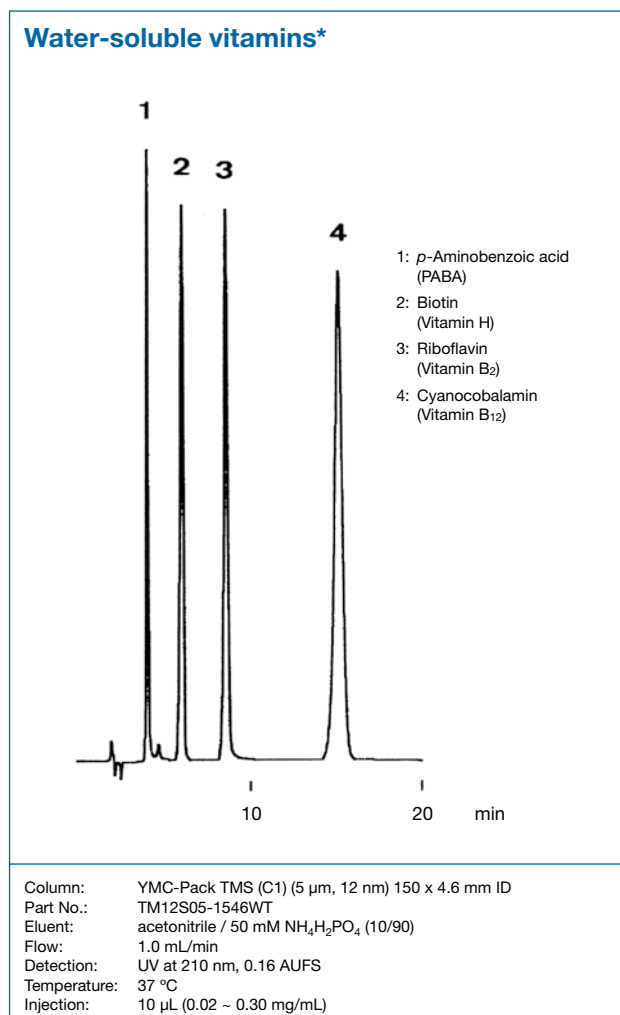
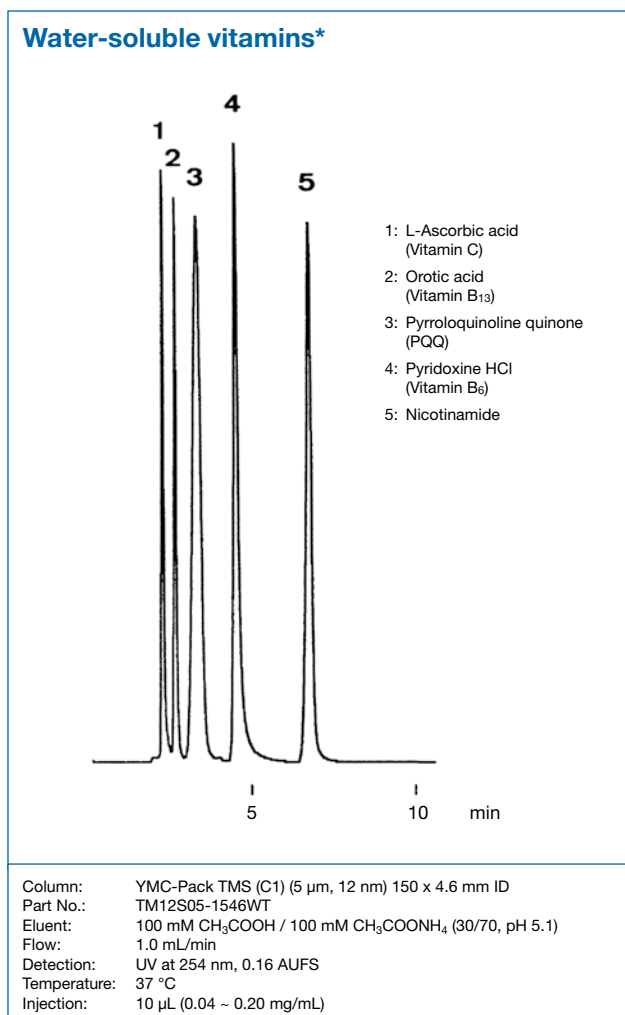

Column care

YMC-Pack TMS (C1) is stable towards hydrolysis between pH 2.0-7.5. Remove acid and buffer salts before storage. Store the column in methanol / water = 70/30. If columns are affected by undesired contaminants or clogged inlet frits which cause back pressure increases, flush the column with THF in the opposite flow direction.

For detailed information please refer to the "Column Care and Use Instructions" which can be downloaded from www.ymc.de.

YMC-Pack CN (Cyano)

- for normal, reversed phase and HILIC applications
- silica gel with cyanopropyl groups
- faster column equilibration than normal silica gel
- most polar reversed phase column



YMC-Pack CN	Specification	
Particle Size / μm	3; 5	5
Pore Size / nm	12	30
Surface area / m^2g^{-1}	330	100
Carbon content / %	7	3
Recommended pH range	2.0 - 7.5	2.0 - 7.5

General

In reversed phase mode, cyano (nitrile) phases are the most polar and least retentive of all reversed phase supports. Extremely hydrophobic compounds, which do not elute on standard C18 and C8 columns with typical reversed phase eluents, can be separated using cyano phases. Separations using reversed and normal phase and HILIC mechanisms can be carried out using this material.

Properties

The cyano chemistry of YMC-Pack CN (Cyano) provides a different selectivity from both phenyl and standard aliphatic (C18, C8 or C4) reversed phases. It is useful for quick and simple analysis of compounds that differ greatly in hydrophobicity, without the need to use gradient elution chromatography.

Cyano packings also provide an alternative to silica material in normal phase chromatography, where bonded normal phase packings have the advantage of faster equilibration, more uniform surface activity and increased resistance to dissolution.

To extend column lifetime continued switching between normal and reversed phase solvents should be avoided.

YMC-Pack CN (Cyano) is also available in preparative particle sizes.

YMC-Pack CN (Cyano)

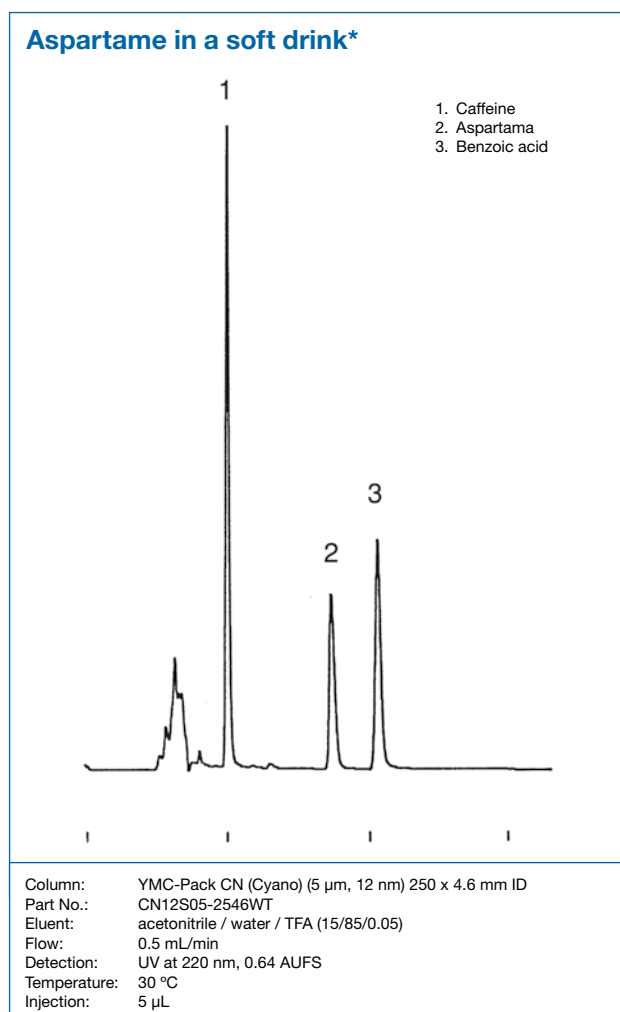
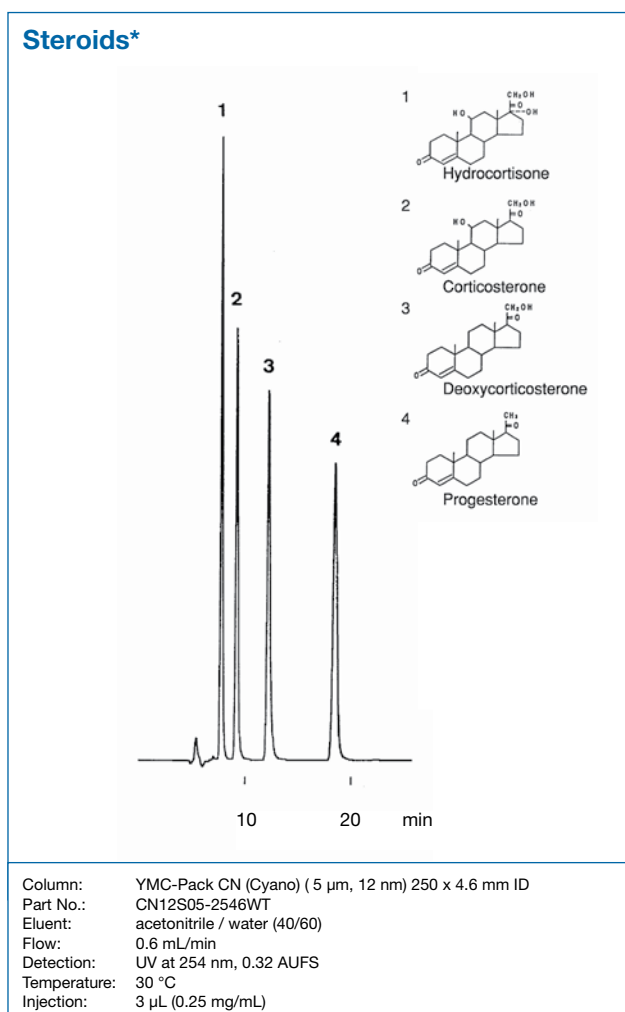

Column care

YMC-Pack CN (Cyano) is stable towards hydrolysis between pH 2.0-7.5. Remove acid and buffer salts before storage. For detailed information please refer to the "Column Care and Use Instructions" which can be downloaded from www.ymc.de.

Ordering Information

YMC-Pack ODS-AQ

Phase dimension	Column ID [mm]	Column length [mm]					Guard cartridges* with 10 mm length [pack of 5]
		30 (WT) / 33 (QT)	50	100	150	250	
12 nm 3 µm	2.1	AQ12S03-H3Q1QT	AQ12S03-05Q1QT	AQ12S03-10Q1QT	AQ12S03-15Q1QT	AQ12S03-25Q1QT	AQ12S03-01Q1GC
	3.0	AQ12S03-H303QT	AQ12S03-0503QT	AQ12S03-1003QT	AQ12S03-1503QT	AQ12S03-2503QT	AQ12S03-0103GC
	4.0	AQ12S03-H304QT	AQ12S03-0504QT	AQ12S03-1004QT	AQ12S03-1504QT	AQ12S03-2504QT	AQ12S03-0104GC
	4.6	AQ12S03-0346WT	AQ12S03-0546WT	AQ12S03-1046WT	AQ12S03-1546WT	AQ12S03-2546WT	AQ12S03-0104GC
20 nm 3 µm	2.1	AQ20S03-H3Q1QT	AQ20S03-05Q1QT	AQ20S03-10Q1QT	AQ20S03-15Q1QT	AQ20S03-25Q1QT	AQ20S03-01Q1GC
	3.0	AQ20S03-H303QT	AQ20S03-0503QT	AQ20S03-1003QT	AQ20S03-1503QT	AQ20S03-2503QT	AQ20S03-0103GC
	4.0	AQ20S03-H304QT	AQ20S03-0504QT	AQ20S03-1004QT	AQ20S03-1504QT	AQ20S03-2504QT	AQ20S03-0104GC
	4.6	AQ20S03-0346WT	AQ20S03-0546WT	AQ20S03-1046WT	AQ20S03-1546WT	AQ20S03-2546WT	AQ20S03-0104GC
12 nm 5 µm	2.1	AQ12S05-H3Q1QT	AQ12S05-05Q1QT	AQ12S05-10Q1QT	AQ12S05-15Q1QT	AQ12S05-25Q1QT	AQ12S05-01Q1GC
	3.0	AQ12S05-H303QT	AQ12S05-0503QT	AQ12S05-1003QT	AQ12S05-1503QT	AQ12S05-2503QT	AQ12S05-0103GC
	4.0	AQ12S05-H304QT	AQ12S05-0504QT	AQ12S05-1004QT	AQ12S05-1504QT	AQ12S05-2504QT	AQ12S05-0104GC
	4.6	AQ12S05-0346WT	AQ12S05-0546WT	AQ12S05-1046WT	AQ12S05-1546WT	AQ12S05-2546WT	AQ12S05-0104GC
20 nm 5 µm	2.1	AQ20S05-H3Q1QT	AQ20S05-05Q1QT	AQ20S05-10Q1QT	AQ20S05-15Q1QT	AQ20S05-25Q1QT	AQ20S05-01Q1GC
	3.0	AQ20S05-H303QT	AQ20S05-0503QT	AQ20S05-1003QT	AQ20S05-1503QT	AQ20S05-2503QT	AQ20S05-0103GC
	4.0	AQ20S05-H304QT	AQ20S05-0504QT	AQ20S05-1004QT	AQ20S05-1504QT	AQ20S05-2504QT	AQ20S05-0104GC
	4.6	AQ20S05-0346WT	AQ20S05-0546WT	AQ20S05-1046WT	AQ20S05-1546WT	AQ20S05-2546WT	AQ20S05-0104GC

*Guard cartridge holder required, part no. XPGCH-Q1

YMC-Pack ODS-A

Phase dimension	Column ID [mm]	Column length [mm]					Guard cartridges* with 10 mm length [pack of 5]
		30 (WT) / 33 (QT)	50	100	150	250	
12 nm 3 µm	2.1	AA12S03-H3Q1QT	AA12S03-05Q1QT	AA12S03-10Q1QT	AA12S03-15Q1QT	AA12S03-25Q1QT	AA12S03-01Q1GC
	3.0	AA12S03-H303QT	AA12S03-0503QT	AA12S03-1003QT	AA12S03-1503QT	AA12S03-2503QT	AA12S03-0103GC
	4.0	AA12S03-H304QT	AA12S03-0504QT	AA12S03-1004QT	AA12S03-1504QT	AA12S03-2504QT	AA12S03-0104GC
	4.6	AA12S03-0346WT	AA12S03-0546WT	AA12S03-1046WT	AA12S03-1546WT	AA12S03-2546WT	AA12S03-0104GC
20 nm 3 µm	2.1	AA20S03-H3Q1QT	AA20S03-05Q1QT	AA20S03-10Q1QT	AA20S03-15Q1QT	AA20S03-25Q1QT	AA20S03-01Q1GC
	3.0	AA20S03-H303QT	AA20S03-0503QT	AA20S03-1003QT	AA20S03-1503QT	AA20S03-2503QT	AA20S03-0103GC
	4.0	AA20S03-H304QT	AA20S03-0504QT	AA20S03-1004QT	AA20S03-1504QT	AA20S03-2504QT	AA20S03-0104GC
	4.6	AA20S03-0346WT	AA20S03-0546WT	AA20S03-1046WT	AA20S03-1546WT	AA20S03-2546WT	AA20S03-0104GC
12 nm 5 µm	2.1	AA12S05-H3Q1QT	AA12S05-05Q1QT	AA12S05-10Q1QT	AA12S05-15Q1QT	AA12S05-25Q1QT	AA12S05-01Q1GC
	3.0	AA12S05-H303QT	AA12S05-0503QT	AA12S05-1003QT	AA12S05-1503QT	AA12S05-2503QT	AA12S05-0103GC
	4.0	AA12S05-H304QT	AA12S05-0504QT	AA12S05-1004QT	AA12S05-1504QT	AA12S05-2504QT	AA12S05-0104GC
	4.6	AA12S05-0346WT	AA12S05-0546WT	AA12S05-1046WT	AA12S05-1546WT	AA12S05-2546WT	AA12S05-0104GC
20 nm 5 µm	2.1	AA20S05-H3Q1QT	AA20S05-05Q1QT	AA20S05-10Q1QT	AA20S05-15Q1QT	AA20S05-25Q1QT	AA20S05-01Q1GC
	3.0	AA20S05-H303QT	AA20S05-0503QT	AA20S05-1003QT	AA20S05-1503QT	AA20S05-2503QT	AA20S05-0103GC
	4.0	AA20S05-H304QT	AA20S05-0504QT	AA20S05-1004QT	AA20S05-1504QT	AA20S05-2504QT	AA20S05-0104GC
	4.6	AA20S05-0346WT	AA20S05-0546WT	AA20S05-1046WT	AA20S05-1546WT	AA20S05-2546WT	AA20S05-0104GC
30 nm 5 µm	2.1	AA30S05-H3Q1QT	AA30S05-05Q1QT	AA30S05-10Q1QT	AA30S05-15Q1QT	AA30S05-25Q1QT	AA30S05-01Q1GC
	3.0	AA30S05-H303QT	AA30S05-0503QT	AA30S05-1003QT	AA30S05-1503QT	AA30S05-2503QT	AA30S05-0103GC
	4.0	AA30S05-H304QT	AA30S05-0504QT	AA30S05-1004QT	AA30S05-1504QT	AA30S05-2504QT	AA30S05-0104GC
	4.6	AA30S05-0346WT	AA30S05-0546WT	AA30S05-1046WT	AA30S05-1546WT	AA30S05-2546WT	AA30S05-0104GC

*Guard cartridge holder required, part no. XPGCH-Q1

YMC-Pack ODS-AM

Phase dimension	Column ID [mm]	Column length [mm]					Guard cartridges* with 10 mm length [pack of 5]
		30 (WT) / 33 (QT)	50	100	150	250	
12 nm 3 µm	2.1	AM12S03-H3Q1QT	AM12S03-05Q1QT	AM12S03-10Q1QT	AM12S03-15Q1QT	AM12S03-25Q1QT	AM12S03-01Q1GC
	3.0	AM12S03-H303QT	AM12S03-0503QT	AM12S03-1003QT	AM12S03-1503QT	AM12S03-2503QT	AM12S03-0103GC
	4.0	AM12S03-H304QT	AM12S03-0504QT	AM12S03-1004QT	AM12S03-1504QT	AM12S03-2504QT	AM12S03-0104GC
	4.6	AM12S03-0346WT	AM12S03-0546WT	AM12S03-1046WT	AM12S03-1546WT	AM12S03-2546WT	AM12S03-0104GC
12 nm 5 µm	2.1	AM12S05-H3Q1QT	AM12S05-05Q1QT	AM12S05-10Q1QT	AM12S05-15Q1QT	AM12S05-25Q1QT	AM12S05-01Q1GC
	3.0	AM12S05-H303QT	AM12S05-0503QT	AM12S05-1003QT	AM12S05-1503QT	AM12S05-2503QT	AM12S05-0103GC
	4.0	AM12S05-H304QT	AM12S05-0504QT	AM12S05-1004QT	AM12S05-1504QT	AM12S05-2504QT	AM12S05-0104GC
	4.6	AM12S05-0346WT	AM12S05-0546WT	AM12S05-1046WT	AM12S05-1546WT	AM12S05-2546WT	AM12S05-0104GC

*Guard cartridge holder required, part no. XPGCH-Q1

Ordering Information

YMC-Pack ODS-AL

Phase dimension	Column ID [mm]	Column length [mm]					Guard cartridges* with 10 mm length [pack of 5]
		30 (WT) / 33 (QT)	50	100	150	250	
12 nm 3 µm	2.1	AL12S03-H3Q1QT	AL12S03-05Q1QT	AL12S03-10Q1QT	AL12S03-15Q1QT	AL12S03-25Q1QT	AL12S03-01Q1GC
	3.0	AL12S03-H303QT	AL12S03-0503QT	AL12S03-1003QT	AL12S03-1503QT	AL12S03-2503QT	AL12S03-0103GC
	4.0	AL12S03-H304QT	AL12S03-0504QT	AL12S03-1004QT	AL12S03-1504QT	AL12S03-2504QT	AL12S03-0104GC
	4.6	AL12S03-0346WT	AL12S03-0546WT	AL12S03-1046WT	AL12S03-1546WT	AL12S03-2546WT	AL12S03-0104GC
12 nm 5 µm	2.1	AL12S05-H3Q1QT	AL12S05-05Q1QT	AL12S05-10Q1QT	AL12S05-15Q1QT	AL12S05-25Q1QT	AL12S05-01Q1GC
	3.0	AL12S05-H303QT	AL12S05-0503QT	AL12S05-1003QT	AL12S05-1503QT	AL12S05-2503QT	AL12S05-0103GC
	4.0	AL12S05-H304QT	AL12S05-0504QT	AL12S05-1004QT	AL12S05-1504QT	AL12S05-2504QT	AL12S05-0104GC
	4.6	AL12S05-0346WT	AL12S05-0546WT	AL12S05-1046WT	AL12S05-1546WT	AL12S05-2546WT	AL12S05-0104GC

*Guard cartridge holder required, part no. XPGCH-Q1

YMC-Pack PolymerC18

Phase dimension	Column ID [mm]	Column length [mm]					Guard cartridges* with 10 mm length [pack of 5]
		30 (WT) / 33 (QT)	50	100	150	250	
6 µm	2.1	PC99S06-H3Q1QT	PC99S06-05Q1QT	PC99S06-10Q1QT	PC99S06-15Q1QT	PC99S06-25Q1QT	PC99S06-01Q1GC
	3.0	PC99S06-H303QT	PC99S06-0503QT	PC99S06-1003QT	PC99S06-1503QT	PC99S06-2503QT	PC99S06-0103GC
	4.0	PC99S06-H304QT	PC99S06-0504QT	PC99S06-1004QT	PC99S06-1504QT	PC99S06-2504QT	PC99S06-0104GC
	4.6	PC99S06-0346WT	PC99S06-0546WT	PC99S06-1046WT	PC99S06-1546WT	PC99S06-2546WT	PC99S06-0104GC

*Guard cartridge holder required, part no. XPGCH-Q1

YMC-Pack C₈

Phase dimension	Column ID [mm]	Column length [mm]					Guard cartridges* with 10 mm length [pack of 5]
		30 (WT) / 33 (QT)	50	100	150	250	
12 nm 3 µm	2.1	OC12S03-H3Q1QT	OC12S03-05Q1QT	OC12S03-10Q1QT	OC12S03-15Q1QT	OC12S03-25Q1QT	OC12S03-01Q1GC
	3.0	OC12S03-H303QT	OC12S03-0503QT	OC12S03-1003QT	OC12S03-1503QT	OC12S03-2503QT	OC12S03-0103GC
	4.0	OC12S03-H304QT	OC12S03-0504QT	OC12S03-1004QT	OC12S03-1504QT	OC12S03-2504QT	OC12S03-0104GC
	4.6	OC12S03-0346WT	OC12S03-0546WT	OC12S03-1046WT	OC12S03-1546WT	OC12S03-2546WT	OC12S03-0104GC
20 nm 3 µm	2.1	OC20S03-H3Q1QT	OC20S03-05Q1QT	OC20S03-10Q1QT	OC20S03-15Q1QT	OC20S03-25Q1QT	OC20S03-01Q1GC
	3.0	OC20S03-H303QT	OC20S03-0503QT	OC20S03-1003QT	OC20S03-1503QT	OC20S03-2503QT	OC20S03-0103GC
	4.0	OC20S03-H304QT	OC20S03-0504QT	OC20S03-1004QT	OC20S03-1504QT	OC20S03-2504QT	OC20S03-0104GC
	4.6	OC20S03-0346WT	OC20S03-0546WT	OC20S03-1046WT	OC20S03-1546WT	OC20S03-2546WT	OC20S03-0104GC
12 nm 5 µm	2.1	OC12S05-H3Q1QT	OC12S05-05Q1QT	OC12S05-10Q1QT	OC12S05-15Q1QT	OC12S05-25Q1QT	OC12S05-01Q1GC
	3.0	OC12S05-H303QT	OC12S05-0503QT	OC12S05-1003QT	OC12S05-1503QT	OC12S05-2503QT	OC12S05-0103GC
	4.0	OC12S05-H304QT	OC12S05-0504QT	OC12S05-1004QT	OC12S05-1504QT	OC12S05-2504QT	OC12S05-0104GC
	4.6	OC12S05-0346WT	OC12S05-0546WT	OC12S05-1046WT	OC12S05-1546WT	OC12S05-2546WT	OC12S05-0104GC
20 nm 5 µm	2.1	OC20S05-H3Q1QT	OC20S05-05Q1QT	OC20S05-10Q1QT	OC20S05-15Q1QT	OC20S05-25Q1QT	OC20S05-01Q1GC
	3.0	OC20S05-H303QT	OC20S05-0503QT	OC20S05-1003QT	OC20S05-1503QT	OC20S05-2503QT	OC20S05-0103GC
	4.0	OC20S05-H304QT	OC20S05-0504QT	OC20S05-1004QT	OC20S05-1504QT	OC20S05-2504QT	OC20S05-0104GC
	4.6	OC20S05-0346WT	OC20S05-0546WT	OC20S05-1046WT	OC20S05-1546WT	OC20S05-2546WT	OC20S05-0104GC
30 nm 5 µm	2.1	OC30S05-H3Q1QT	OC30S05-05Q1QT	OC30S05-10Q1QT	OC30S05-15Q1QT	OC30S05-25Q1QT	OC30S05-01Q1GC
	3.0	OC30S05-H303QT	OC30S05-0503QT	OC30S05-1003QT	OC30S05-1503QT	OC30S05-2503QT	OC30S05-0103GC
	4.0	OC30S05-H304QT	OC30S05-0504QT	OC30S05-1004QT	OC30S05-1504QT	OC30S05-2504QT	OC30S05-0104GC
	4.6	OC30S05-0346WT	OC30S05-0546WT	OC30S05-1046WT	OC30S05-1546WT	OC30S05-2546WT	OC30S05-0104GC

*Guard cartridge holder required, part no. XPGCH-Q1

Ordering Information

YMC-Pack C₄

Phase dimension	Column ID [mm]	Column length [mm]					Guard cartridges* with 10 mm length [pack of 5]
		30 (WT) / 33 (QT)	50	100	150	250	
12 nm 3 µm	2.1	BU12S03-H3Q1QT	BU12S03-05Q1QT	BU12S03-10Q1QT	BU12S03-15Q1QT	BU12S03-25Q1QT	BU12S03-01Q1GC
	3.0	BU12S03-H303QT	BU12S03-0503QT	BU12S03-1003QT	BU12S03-1503QT	BU12S03-2503QT	BU12S03-0103GC
	4.0	BU12S03-H304QT	BU12S03-0504QT	BU12S03-1004QT	BU12S03-1504QT	BU12S03-2504QT	BU12S03-0104GC
	4.6	BU12S03-0346WT	BU12S03-0546WT	BU12S03-1046WT	BU12S03-1546WT	BU12S03-2546WT	BU12S03-0104GC
20 nm 3 µm	2.1	BU20S03-H3Q1QT	BU20S03-05Q1QT	BU20S03-10Q1QT	BU20S03-15Q1QT	BU20S03-25Q1QT	BU20S03-01Q1GC
	3.0	BU20S03-H303QT	BU20S03-0503QT	BU20S03-1003QT	BU20S03-1503QT	BU20S03-2503QT	BU20S03-0103GC
	4.0	BU20S03-H304QT	BU20S03-0504QT	BU20S03-1004QT	BU20S03-1504QT	BU20S03-2504QT	BU20S03-0104GC
	4.6	BU20S03-0346WT	BU20S03-0546WT	BU20S03-1046WT	BU20S03-1546WT	BU20S03-2546WT	BU20S03-0104GC
12 nm 5 µm	2.1	BU12S05-H3Q1QT	BU12S05-05Q1QT	BU12S05-10Q1QT	BU12S05-15Q1QT	BU12S05-25Q1QT	BU12S05-01Q1GC
	3.0	BU12S05-H303QT	BU12S05-0503QT	BU12S05-1003QT	BU12S05-1503QT	BU12S05-2503QT	BU12S05-0103GC
	4.0	BU12S05-H304QT	BU12S05-0504QT	BU12S05-1004QT	BU12S05-1504QT	BU12S05-2504QT	BU12S05-0104GC
	4.6	BU12S05-0346WT	BU12S05-0546WT	BU12S05-1046WT	BU12S05-1546WT	BU12S05-2546WT	BU12S05-0104GC
20 nm 5 µm	2.1	BU20S05-H3Q1QT	BU20S05-05Q1QT	BU20S05-10Q1QT	BU20S05-15Q1QT	BU20S05-25Q1QT	BU20S05-01Q1GC
	3.0	BU20S05-H303QT	BU20S05-0503QT	BU20S05-1003QT	BU20S05-1503QT	BU20S05-2503QT	BU20S05-0103GC
	4.0	BU20S05-H304QT	BU20S05-0504QT	BU20S05-1004QT	BU20S05-1504QT	BU20S05-2504QT	BU20S05-0104GC
	4.6	BU20S05-0346WT	BU20S05-0546WT	BU20S05-1046WT	BU20S05-1546WT	BU20S05-2546WT	BU20S05-0104GC
30 nm 5 µm	2.1	BU30S05-H3Q1QT	BU30S05-05Q1QT	BU30S05-10Q1QT	BU30S05-15Q1QT	BU30S05-25Q1QT	BU30S05-01Q1GC
	3.0	BU30S05-H303QT	BU30S05-0503QT	BU30S05-1003QT	BU30S05-1503QT	BU30S05-2503QT	BU30S05-0103GC
	4.0	BU30S05-H304QT	BU30S05-0504QT	BU30S05-1004QT	BU30S05-1504QT	BU30S05-2504QT	BU30S05-0104GC
	4.6	BU30S05-0346WT	BU30S05-0546WT	BU30S05-1046WT	BU30S05-1546WT	BU30S05-2546WT	BU30S05-0104GC

*Guard cartridge holder required, part no. XPGCH-Q1

YMC-Pack Ph (Phenyl)

Phase dimension	Column ID [mm]	Column length [mm]					Guard cartridges* with 10 mm length [pack of 5]
		30 (WT) / 33 (QT)	50	100	150	250	
12 nm 3 µm	2.1	PH12S03-H3Q1QT	PH12S03-05Q1QT	PH12S03-10Q1QT	PH12S03-15Q1QT	PH12S03-25Q1QT	PH12S03-01Q1GC
	3.0	PH12S03-H303QT	PH12S03-0503QT	PH12S03-1003QT	PH12S03-1503QT	PH12S03-2503QT	PH12S03-0103GC
	4.0	PH12S03-H304QT	PH12S03-0504QT	PH12S03-1004QT	PH12S03-1504QT	PH12S03-2504QT	PH12S03-0104GC
	4.6	PH12S03-0346WT	PH12S03-0546WT	PH12S03-1046WT	PH12S03-1546WT	PH12S03-2546WT	PH12S03-0104GC
12 nm 5 µm	2.1	PH12S05-H3Q1QT	PH12S05-05Q1QT	PH12S05-10Q1QT	PH12S05-15Q1QT	PH12S05-25Q1QT	PH12S05-01Q1GC
	3.0	PH12S05-H303QT	PH12S05-0503QT	PH12S05-1003QT	PH12S05-1503QT	PH12S05-2503QT	PH12S05-0103GC
	4.0	PH12S05-H304QT	PH12S05-0504QT	PH12S05-1004QT	PH12S05-1504QT	PH12S05-2504QT	PH12S05-0104GC
	4.6	PH12S05-0346WT	PH12S05-0546WT	PH12S05-1046WT	PH12S05-1546WT	PH12S05-2546WT	PH12S05-0104GC
30 nm 5 µm	2.1	PH30S05-H3Q1QT	PH30S05-05Q1QT	PH30S05-10Q1QT	PH30S05-15Q1QT	PH30S05-25Q1QT	PH30S05-01Q1GC
	3.0	PH30S05-H303QT	PH30S05-0503QT	PH30S05-1003QT	PH30S05-1503QT	PH30S05-2503QT	PH30S05-0103GC
	4.0	PH30S05-H304QT	PH30S05-0504QT	PH30S05-1004QT	PH30S05-1504QT	PH30S05-2504QT	PH30S05-0104GC
	4.6	PH30S05-0346WT	PH30S05-0546WT	PH30S05-1046WT	PH30S05-1546WT	PH30S05-2546WT	PH30S05-0104GC

*Guard cartridge holder required, part no. XPGCH-Q1

YMC-Pack TMS

Phase dimension	Column ID [mm]	Column length [mm]					Guard cartridges* with 10 mm length [pack of 5]
		30 (WT) / 33 (QT)	50	100	150	250	
12 nm 3 µm	2.1	TM12S03-H3Q1QT	TM12S03-05Q1QT	TM12S03-10Q1QT	TM12S03-15Q1QT	TM12S03-25Q1QT	TM12S03-01Q1GC
	3.0	TM12S03-H303QT	TM12S03-0503QT	TM12S03-1003QT	TM12S03-1503QT	TM12S03-2503QT	TM12S03-0103GC
	4.0	TM12S03-H304QT	TM12S03-0504QT	TM12S03-1004QT	TM12S03-1504QT	TM12S03-2504QT	TM12S03-0104GC
	4.6	TM12S03-0346WT	TM12S03-0546WT	TM12S03-1046WT	TM12S03-1546WT	TM12S03-2546WT	TM12S03-0104GC
12 nm 5 µm	2.1	TM12S05-H3Q1QT	TM12S05-05Q1QT	TM12S05-10Q1QT	TM12S05-15Q1QT	TM12S05-25Q1QT	TM12S05-01Q1GC
	3.0	TM12S05-H303QT	TM12S05-0503QT	TM12S05-1003QT	TM12S05-1503QT	TM12S05-2503QT	TM12S05-0103GC
	4.0	TM12S05-H304QT	TM12S05-0504QT	TM12S05-1004QT	TM12S05-1504QT	TM12S05-2504QT	TM12S05-0104GC
	4.6	TM12S05-0346WT	TM12S05-0546WT	TM12S05-1046WT	TM12S05-1546WT	TM12S05-2546WT	TM12S05-0104GC

*Guard cartridge holder required, part no. XPGCH-Q1

Ordering Information

YMC-Pack CN (Cyano)

Phase dimension	Column ID [mm]	Column length [mm]					Guard cartridges* with 10 mm length [pack of 5]
		30 (WT) / 33 (QT)	50	100	150	250	
12 nm 3 µm	2.1	CN12S03-H3Q1QT	CN12S03-05Q1QT	CN12S03-10Q1QT	CN12S03-15Q1QT	CN12S03-25Q1QT	CN12S03-01Q1GC
	3.0	CN12S03-H303QT	CN12S03-0503QT	CN12S03-1003QT	CN12S03-1503QT	CN12S03-2503QT	CN12S03-0103GC
	4.0	CN12S03-H304QT	CN12S03-0504QT	CN12S03-1004QT	CN12S03-1504QT	CN12S03-2504QT	CN12S03-0104GC
	4.6	CN12S03-0346WT	CN12S03-0546WT	CN12S03-1046WT	CN12S03-1546WT	CN12S03-2546WT	CN12S03-0104GC
12 nm 5 µm	2.1	CN12S05-H3Q1QT	CN12S05-05Q1QT	CN12S05-10Q1QT	CN12S05-15Q1QT	CN12S05-25Q1QT	CN12S05-01Q1GC
	3.0	CN12S05-H303QT	CN12S05-0503QT	CN12S05-1003QT	CN12S05-1503QT	CN12S05-2503QT	CN12S05-0103GC
	4.0	CN12S05-H304QT	CN12S05-0504QT	CN12S05-1004QT	CN12S05-1504QT	CN12S05-2504QT	CN12S05-0104GC
	4.6	CN12S05-0346WT	CN12S05-0546WT	CN12S05-1046WT	CN12S05-1546WT	CN12S05-2546WT	CN12S05-0104GC
30 nm 5 µm	2.1	CN30S05-H3Q1QT	CN30S05-05Q1QT	CN30S05-10Q1QT	CN30S05-15Q1QT	CN30S05-25Q1QT	CN30S05-01Q1GC
	3.0	CN30S05-H303QT	CN30S05-0503QT	CN30S05-1003QT	CN30S05-1503QT	CN30S05-2503QT	CN30S05-0103GC
	4.0	CN30S05-H304QT	CN30S05-0504QT	CN30S05-1004QT	CN30S05-1504QT	CN30S05-2504QT	CN30S05-0104GC
	4.6	CN30S05-0346WT	CN30S05-0546WT	CN30S05-1046WT	CN30S05-1546WT	CN30S05-2546WT	CN30S05-0104GC

*Guard cartridge holder required, part no. XPGCH-Q1

YMCbasic

Phase dimension	Column ID [mm]	Column length [mm]					Guard cartridges* with 10 mm length [pack of 5]
		30 (WT) / 33 (QT)	50	100	150	250	
3 µm	2.1	BA99S03-H3Q1QT	BA99S03-05Q1QT	BA99S03-10Q1QT	BA99S03-15Q1QT	BA99S03-25Q1QT	BA99S03-01Q1GC
	3.0	BA99S03-H303QT	BA99S03-0503QT	BA99S03-1003QT	BA99S03-1503QT	BA99S03-2503QT	BA99S03-0103GC
	4.0	BA99S03-H304QT	BA99S03-0504QT	BA99S03-1004QT	BA99S03-1504QT	BA99S03-2504QT	BA99S03-0104GC
	4.6	BA99S03-0346WT	BA99S03-0546WT	BA99S03-1046WT	BA99S03-1546WT	BA99S03-2546WT	BA99S03-0104GC
5 µm	2.1	BA99S05-H3Q1QT	BA99S05-05Q1QT	BA99S05-10Q1QT	BA99S05-15Q1QT	BA99S05-25Q1QT	BA99S05-01Q1GC
	3.0	BA99S05-H303QT	BA99S05-0503QT	BA99S05-1003QT	BA99S05-1503QT	BA99S05-2503QT	BA99S05-0103GC
	4.0	BA99S05-H304QT	BA99S05-0504QT	BA99S05-1004QT	BA99S05-1504QT	BA99S05-2504QT	BA99S05-0104GC
	4.6	BA99S05-0346WT	BA99S05-0546WT	BA99S05-1046WT	BA99S05-1546WT	BA99S05-2546WT	BA99S05-0104GC

*Guard cartridge holder required, part no. XPGCH-Q1

For other dimensions please refer to page 352-353





Normal Phase Chemistries

Contents

YMC-Pack SIL (Silica).....	168-169
YMC-Pack PVA-Sil	170-171
YMC-Pack CN (Cyano).....	172-173
YMC-Pack Diol-NP	174-175
YMC-Pack Polyamine II	176-177
YMC-Pack NH ₂ (Amino)	178
YMC-Pack TMS (C1)	179
Ordering Information.....	180-181

Introduction

HPLC Columns for Normal Phase Chromatography

Whilst historically it was the earliest form of HPLC, normal phase separations have recently less attention due to the belief that it is complicated and unpredictable. But normal-phase chromatography is a powerful tool for the separation of positional isomers that are difficult to separate in reversed-phase mode. Due to a rigid surface in comparison with the more flexible carbon chains of reversed phase stationary phases the analytes are effected by well defined steric interaction with polar groups.

This section gives a comprehensive overview of the stationary phases available from YMC for the use in normal phase separation mode. YMC offers columns packed with non-bonded silica or packed with silica gel modified with polar groups.

YMC-Pack SIL (Silica)

- ultra high purity silica
- high mechanical stability
- highly porous, totally spherical particles
- fully scalable for analytical, semi-prep, preparative and process scale applications
- convenient for separating small organic compounds with similar structures



YMC-Pack SIL	Specification			
Particle Size / μm	3; 5	3; 5	3; 5	5
Pore Size / nm	6	12	20	30
Surface area / m^2g^{-1}	450	330	175	100
Recommended pH range	2.0 - 7.5	2.0 - 7.5	2.0 - 7.5	2.0 - 7.5

General

Due to the highly sophisticated production process YMC's spherical silica material shows outstanding performance and great lot-to-lot reproducibility. The reason for this can be summarised in two main qualities: very narrow physical and chemical product specifications and outstanding purity.

Properties

The high purity YMC-Pack SIL (Silica) allows almost total sample recovery because the low content of impurities such as residual metals reduces non-specific sample adsorption. This also prevents unusual peak-shapes thereby encouraging higher sample loading. In addition, the porous structure of the spheres gives a high surface area which further improves sample loading.

Compared with irregular silica, YMC's spherical material is subject to a much lower degree of mechanical degradation during packing and usage. This results in lower backpressures and extended column life times due to the absence of 'fines'.

Since YMC spherical silica is the basis for most YMC bonded phases, this is a further reason for the premium quality of YMC stationary phases as far as backpressure and chromatographic stability is concerned.

YMC-Pack SIL (Silica) is also available in preparative particle sizes, e.g. 10 - 20 - 50 μm (YMC*Gel SIL-HG) and in multi-ton scale (refer to page 312).

Ultra High Purity Silica*

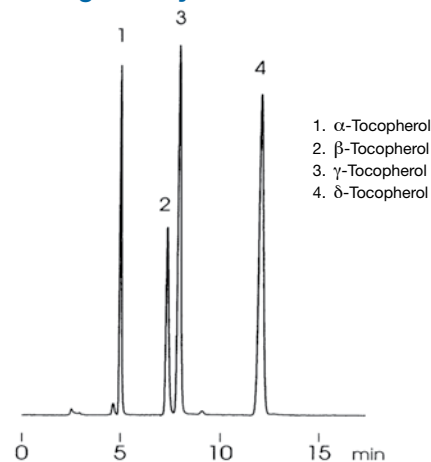

1. α -Tocopherol
2. β -Tocopherol
3. γ -Tocopherol
4. δ -Tocopherol

Column: YMC-Pack SIL (5 μm , 12 nm) 250 x 4.6 mm ID
 Part No.: SL12S05-2546WT
 Eluent: hexane / 2-propanol / acetic acid (1000/6/5)
 Flow: 1.4 mL/min
 Detection: FLS at Ex 298 nm, Em 325 nm
 Temperature: 35 $^{\circ}\text{C}$
 Injection: 20 μL (5 ~ 20 mg/mL)

YMC-Pack SIL (Silica)

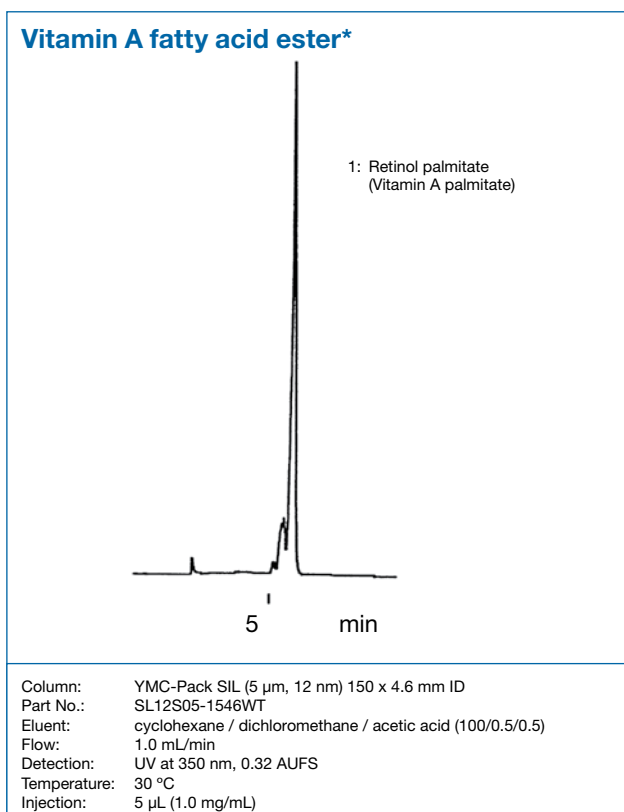
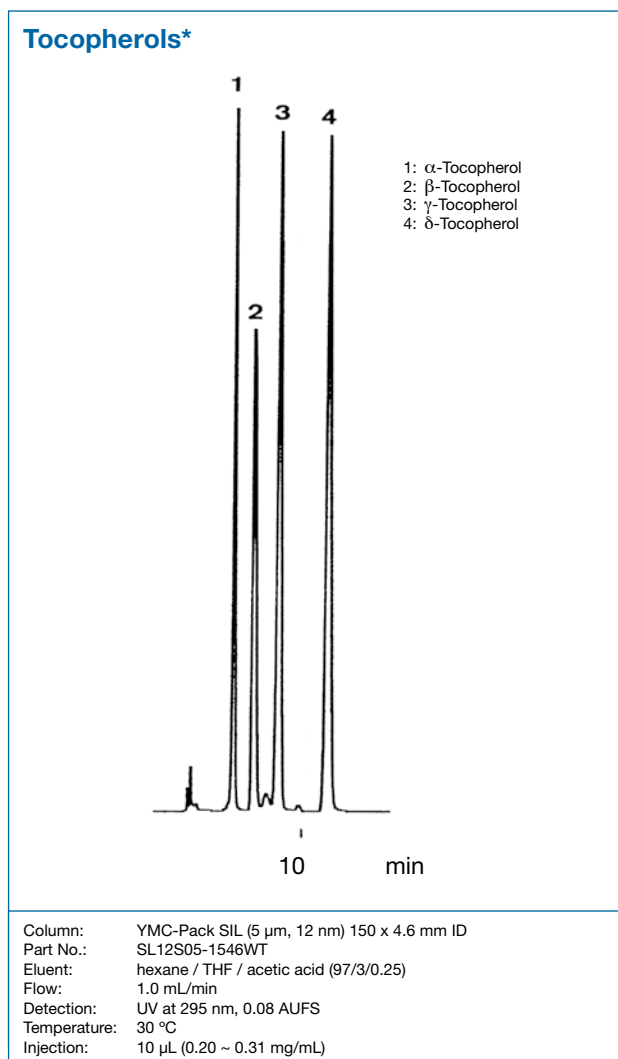
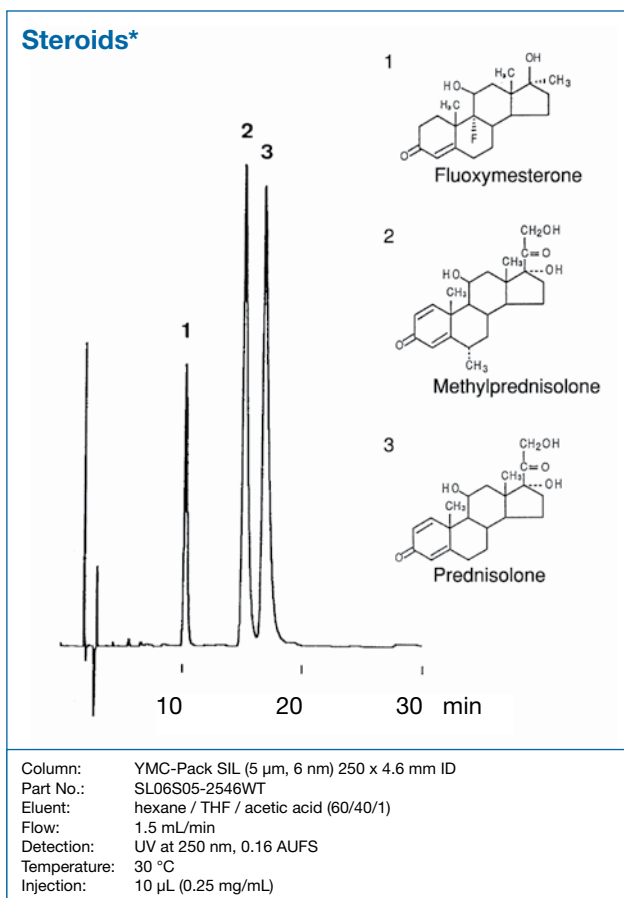

Column care

YMC-Pack SIL is stable towards hydrolysis between pH 2.0-7.5. Remove acid and buffer salts before storage. For detailed information please refer to the "Column Care and Use Instructions" which can be downloaded from www.ymc.de.

YMC-Pack PVA-Sil

- bonded phase alternative to silica for normal phase applications
- consistent surface activity, unaffected by water
- vinyl alcohol polymerised silica support
- suitable for supercritical fluid chromatography (SFC)



YMC-Pack PVA-Sil	Specification
Particle Size / μm	5
Pore Size / nm	12
Surface area / m^2g^{-1}	330
Recommended pH range	2.0 - 9.5

Polyvinyl Alcohol Functionalised Silica

PVA-Sil is prepared from a 5 micron 12nm silica support which is bonded with a monomolecular polymer coating of vinyl alcohol. The polymerised PVA completely covers both external and internal surfaces of the silica support, protecting it against aggressive, high pH buffers and solvents.

Normal phase alternative to Silica

PVA-Sil, which possesses a polyvinyl alcohol (PVA) surface chemistry, is an excellent alternative to silica gel or other polar bonded phases which are used in normal phase chromatography. In many situations it exhibits better performance characteristics and a unique selectivity and can often resolve compounds that behave poorly on silica. The alcohol functionality present on PVA-Sil is better suited for troublesome compounds, such organic bases, than acidic silanols present in unbonded silica.

Highly stable and reproducible

Since PVA-Sil is a bonded stationary phase, it can be washed with solvents of any polarity, from hexane through water, without altering the surface activity. Therefore selectivity, retention and resolution are reproducible regardless of the column's previous history. This is not true of bare silica, which easily becomes completely deactivated following the introduction of even small quantity of water.

Provides high sample recovery

The surface of PVA-Sil is very uniform without the highly active acidic silanol sites on bare silica which can cause decomposition of sensitive molecules. Because of consistent surface activity, PVA-Sil exhibits neither non-specific irreversible adsorption nor sample degradation. This is a problem often encountered with bare silica columns. The lack of non-specific adsorption and the uniformity of the polyvinyl alcohol bonded surface means that, unlike silica, PVA-Sil can be reused over and over without fear of contamination or carryover. Sample recoveries on PVA-Sil typically average 90% or higher.

Excellent choice for packed column SFC

The PVA polymer shell on PVA-Sil deactivates the silica support while providing a hydrophilic surface. YMC-Pack PVA-Sil columns are well suited for SFC separations.

Column Care

YMC-Pack PVA-Sil is stable towards hydrolysis between pH 2.0-9.5. Remove acid and buffer salts before storage. For detailed information please refer to the "Column Care and Use Instructions" which can be downloaded from www.ymc.de.

YMC-Pack PVA-Sil

Analysis of Potato Lipids*

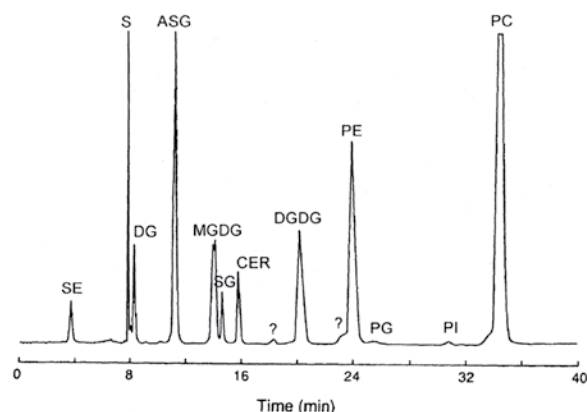

Column: YMC-Pack PVA-Sil (5 µm, 12 nm) 250 x 4.6 mm ID
 Part No.: PV12S05-2546WT
 Flow rate: 1 to 2 mL/min
 Mobile Phase: A: iso-hexane / methyl ter butyl ether (98:2)
 B: propan-2-ol / ACN / CHCl₃ / CH₃OOH (84:8:8:0.025)
 C: propan-2-ol / water / triethylamine (50:50:0.2)

Gradient:

Tmin:	0	5	15	40	40.1	45	50
B%:	0	20	52	52	70	0	0
C%:	0	0	4	14	0	0	0
Flow (mL/mn):	1	1	1	1.4	1.4	2	2

Nebuliser temperature: 25 °C, Evaporation temperature: 35 °C

S: Sterols SE: Sterol Esters SG: Steryl glycosides
 MGDG: Monogalactosyldiacylglycerols DGDG: Digalactosyldiacylglycerols
 PE: Phosphatidylethanolamine PG: Phosphatidyl glycerols
 PC: Phosphatidylcholine ASG: Acylsterylglycosides
 PI: Phosphatidylinositol DG: Diacylglycerol
 CER: Cerebrosides

Literature: W.W. Christie; R.A. Urwin, J. high Resol. Chromatogr., Vol. 18 (1995) p.97 - 100

Uracil (in HILIC-mode)*

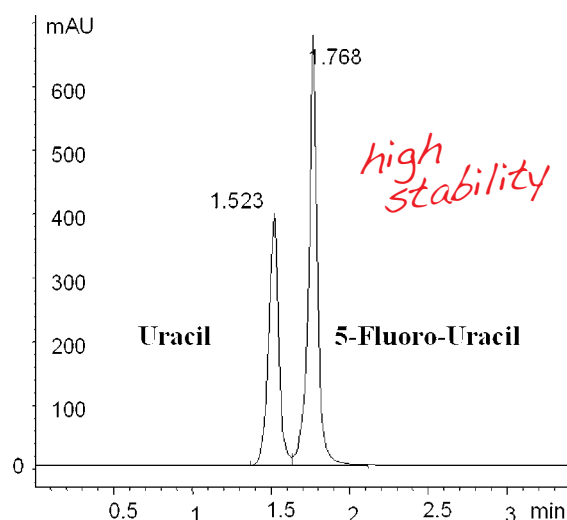

Column: YMC-Pack PVA-Sil (5 µm, 12 nm) 100 x 3.0 mm ID
 Part No.: PV12S05-1003WT
 Eluent: acetonitrile / CH₃COONH₄; 200 mM, pH 5.5
 isocratic (95/5)
 Flow rate: 0.9 mL/min
 Detection: UV at 275 nm

Analysis of Lipids

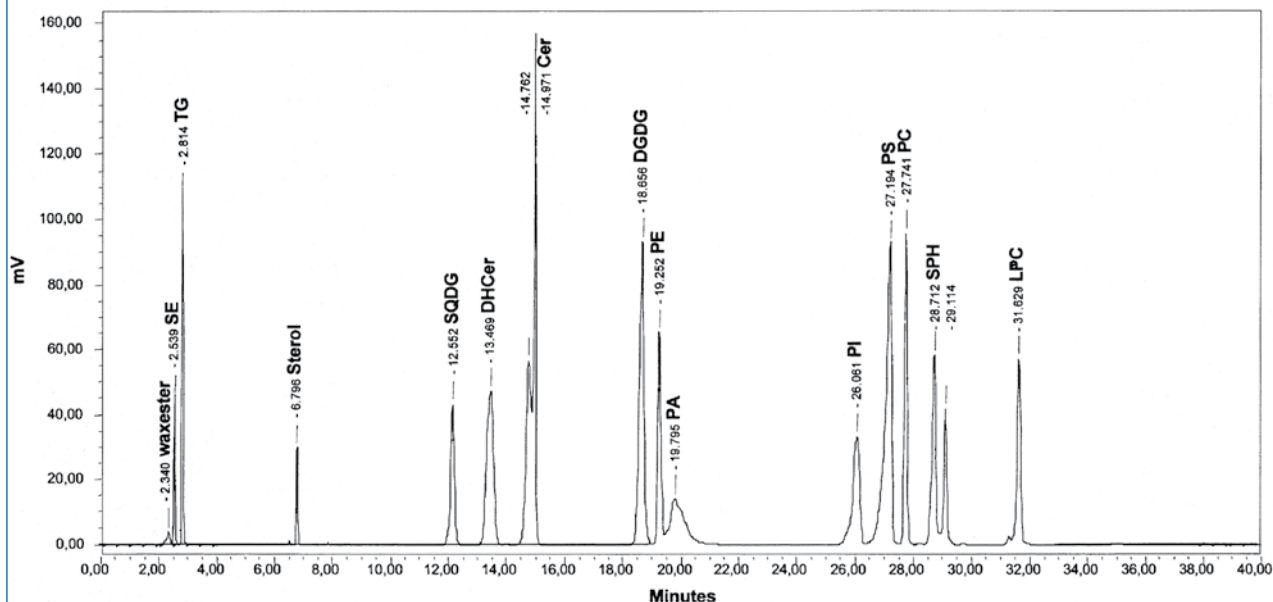

Column: YMC-Pack PVA-Sil (5 µm, 12 nm) 250 x 4.0 mm ID
 Part No.: PV12S05-2504QT
 Eluent: A: n-hexane / tert-methylbutyl ether (98:2)
 B: isopropanol / acetonitrile / chloroform / acetic acid (84:8:8:0.025)
 C: isopropanol / water / triethylamine (50:50:0.2)
 plus 5 mM ammonium sulfate
 Flow rate: 1 mL/min
 Detector: ELSD

SE: steryl oleate PE: PE-dipalmitoyl
 TG: TAG/tripentadecanoin PA: PA-diheptadecanoyl
 Sterol: stigmasterol/sitosterol PI: PI-diheptadecanoyl
 SQDG: sulfoquinovosyldiacylglycerol PS: PS-diheptadecanoyl
 SHC: dehydroxycerebroside PC: PC-diheptadecanoyl
 Cer: cerebroside SPH: sphingomyelin
 DGDG: digalactosyldiacylglycerol LPC: lysophosphatidylcholine

Literature: JAOCS, Vol. 80, no. 8 (2003) p. 747-753

YMC-Pack CN (Cyano)

- silica gel chemically bound with cyanopropyl groups
- faster column equilibration than normal silica gel



YMC-Pack CN	Specification	
Particle Size / μm	3; 5	5
Pore Size / nm	12	30
Surface area / m^2g^{-1}	330	100
Carbon content / %	7	3
Recommended pH range	2.0 - 7.5	2.0 - 7.5

General

Cyano packings also provide an alternative to silica material in normal phase chromatography, where bonded normal phase packings have the advantage of faster equilibration, more uniform surface activity and increased resistance to dissolution.

To extend column lifetime continued switching between normal and reversed phase solvents should be avoided. Both reversed and normal phase separations can be carried out on this material.

YMC-Pack CN (Cyano) is also available in preparative particle sizes.

YMC-Pack CN (Cyano)

YMC-Pack CN Separation Modes

YMC-Pack CN can be used either in reversed phase and normal phase modes since it provides cyanopropyl groups of medium polarity. It can be employed in reversed phase mode with an aqueous mobile phase of higher polarity and in normal phase mode with a lower polarity than the stationary phase. This results in an important phenomenon for large-scale work; the elution order will be inverted by use of the alternate separation mode.

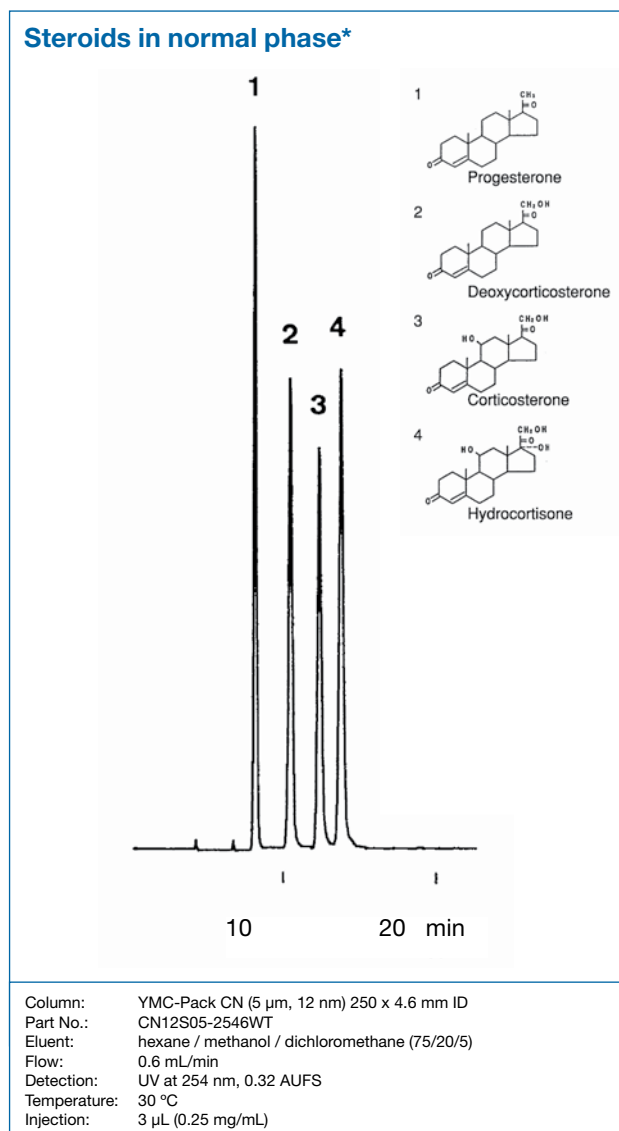
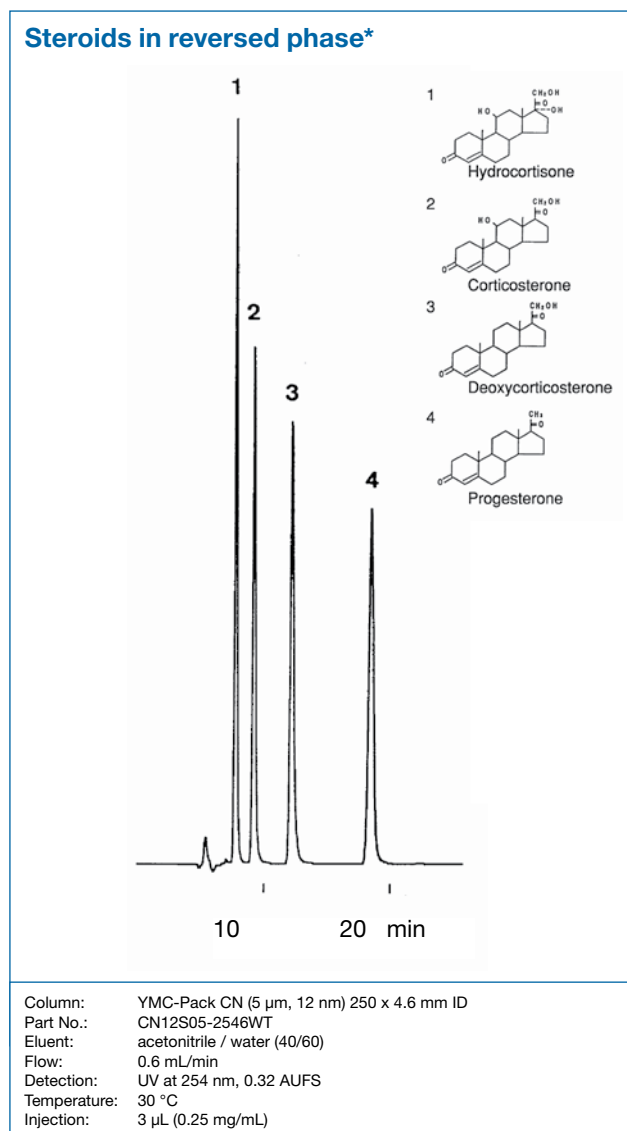

Column care

YMC-Pack CN is stable towards hydrolysis between pH 2.0-7.5. Remove acid and buffer salts before storage. For detailed information please refer to the "Column Care and Use Instructions" which can be downloaded from www.ymc.de.

YMC-Pack Diol-NP

- good selectivity without excessive retention
- high product recovery rate
- high preparative loading
- reproducibility
- improved peak shape versus bare silica
- gel filtration on a silica based material for aqueous size separations



YMC-Pack Diol-NP	Specification	
Particle Size / μm	5	5
Pore Size / nm	6	12
Surface area / m^2g^{-1}	450	330
Recommended pH range (NP)	2.0 - 7.5	2.0 - 7.5
(SEC)	5.0 - 7.5	5.0 - 7.5

General

In normal phase mode the YMC-Pack Diol stationary phase is a versatile alternative to silica. The bonded phase's hydroxyl groups provide good selectivity without excessive retention, since hydrogen bonding with the diol layer is not as strong as with the silanols on a bare silica surface. Diol columns also provide improved reproducibility when compared with bare silica.

Diol packings are suitable for separations using reversed phase techniques or molecular weight determination of proteins by gel filtration.

Properties

As with all YMC silica based bonded phases, YMC-Pack Diol starts with a base silica support of exceptional purity. YMC manufacturing and quality control procedures ensure that the silica has a very low residual metal content. The silica purity greatly reduces non-specific sample adsorption, thereby providing excellent sample recovery.

The high surface area, together with the large number of available sites for interaction of the 1,2-dihydroxypropane ligands, provides high preparative loading.

YMC-Pack Diol SEC columns for separation and MW determination of biomolecules may be found on page 199-212.

YMC-Pack Diol packings can be cleaned repeatedly with methanol, or even water. When combined with the high mechanical strength of the pure base silica, this washability means that YMC[®] Gel Diol packings provide longer column life than underivatized silica.

YMC-Pack Diol is also available in preparative particle sizes.

YMC-Pack Diol-NP

Separations of phenols*

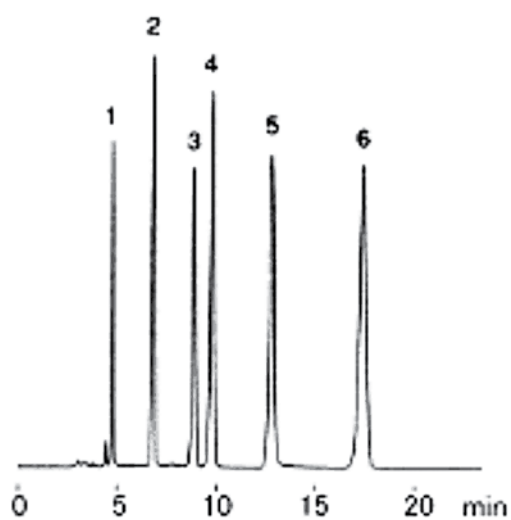

1. Phenol
2. Catechol
3. Resorcinol
4. Hydroquinone
5. Pyrogallol
6. Phloroglucinol

Column: YMC-Pack Diol-NP (DN) (5 μ m, 12 nm) 250 x 4.6 mm ID
Part No.: DN12S05-2546WT
Eluent: hexane / ethanol (80/20)
Flow rate: 1.0 mL/min
Temperature: 30 °C
Detection: UV at 254 nm

Column care

YMC-Pack Diol is stable towards hydrolysis between pH 5.0-7.5 in reversed phase mode (DL) and pH 2.0-7.5 in normal phase mode (DN). Remove acid and buffer salts before storage. For detailed information please refer to the "Column Care and Use Instructions" which can be downloaded from www.ymc.de.

YMC-Pack Polyamine II

- amino phase with polymeric surface
- exclusively 2° and 3° amino groups
- stable towards hydrolysis and oxidation
- high recovery
- excellent life-time

- saccharides and derivatives
- nucleotides
- tocopherols
- for RP- and NP-mode separations



YMC-Pack Polyamine II	Specification
Particle Size / μm	5
Pore Size / nm	12
Surface area / m^2g^{-1}	n/a
Carbon content / %	n/a
Recommended pH range	2.0 - 7.5

General

The chromatographic separation and the reliable quantitation of saccharides is increasingly important in many areas of food technology, life science and in pharmaceutical industry.

For these particular applications, YMC provides YMC-Pack Polyamine II, a polymer amino phase.

Properties

YMC-Pack Polyamine II is based on ultra-pure YMC silica as a support material. The functionality of the stationary phase is achieved by a covalently bonded polymer layer containing secondary (2°) and tertiary (3°) amino groups. The 2° and 3° amino groups of YMC-Pack Polyamine II are only weakly nucleophilic, exhibiting a significantly reduced reactivity against carbonyl compounds. Therefore, unlike conventional amino phases with primary n-propyl-amino ligands, YMC-Pack Polyamine II does not tend to the formation of Schiff's bases or other stable condensation products. In addition, the 2° and 3° amino groups of the polymer layer are to a large extent resistant to oxidation and hydrolysis (see figure next page).

The low reactivity of the 2° and 3° amino groups preserves the long-term retention characteristics and selectivity of YMC-Pack Polyamine II.

Compared to conventional amino phases, one of their most outstanding benefits is the significantly prolonged lifetime. As the silica matrix is completely polymer coated, even the short-term use of basic eluents up to pH 10.5 is possible.

Reducing sugars are often adsorbed irreversibly to conventional amino phases, which causes problems in their recovery and quantitation. In YMC-Pack Polyamine II columns however, the adsorption of reducing sugars plays only a minor role. As a result, a high recovery of these compounds can be obtained which is beneficial for accurate and reliable quantitation.

Column care

YMC-Pack Polyamine II is stable towards hydrolysis between pH 2.0-9.0. Remove acid and buffer salts before storage. For detailed information please refer to the "Column Care and Use Instructions" which can be downloaded from www.ymc.de.

YMC-Pack Polyamine II

Stability of amino type packings*

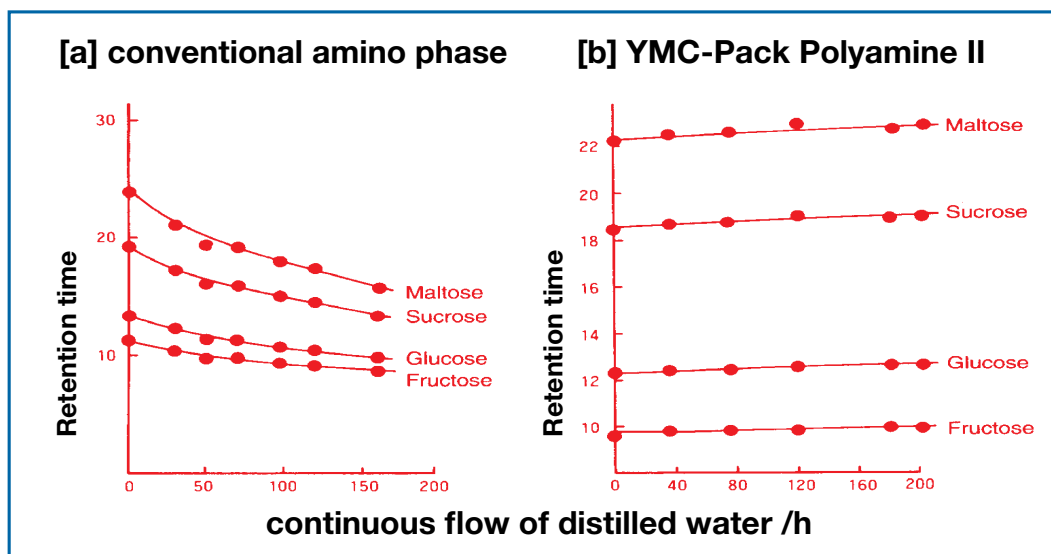

Tocopherols*

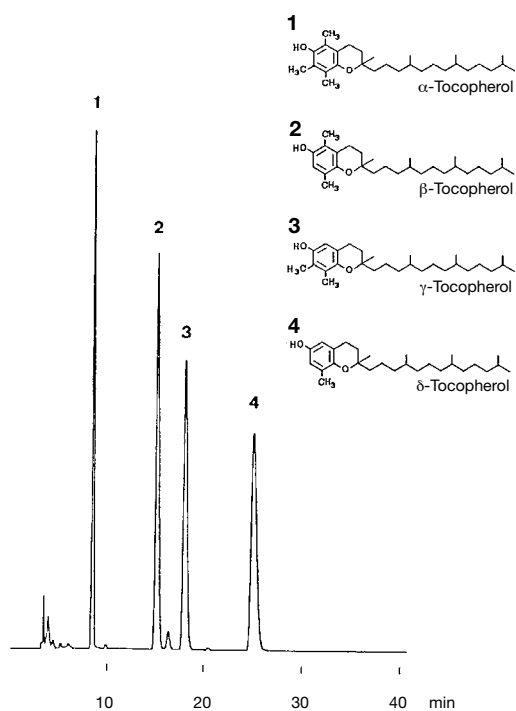

Column: YMC-Pack Polyamine II (5 μ m, 12 nm) 250 x 4.6 mm ID
 Part No.: PB12S05-2546WT
 Eluent: hexane / ethylacetate = 70/30
 Flow: 1.0 mL/min
 Detection: UV, 295 nm
 Temperature: 30 °C

YMC-Pack NH₂ (Amino)

- primary amine (-NH₂) functionality
- stable, high coverage monomeric bonded chemistry
- available in analytical, semi-prep and preparative column sizes



YMC-Pack NH ₂	Specification
Particle Size / μm	3; 5
Pore Size / nm	12
Surface area / m^2g^{-1}	330
Recommended pH range	2.0 - 7.5

General

YMC-Pack NH₂ (Amino) packings are specifically useful for the analysis of mono- and polysaccharides under aggressive normal phase elution conditions. They can also be used in place of silica for conventional normal phase chromatography using nonpolar solvents.

Properties

YMC-Pack NH₂ (Amino) is based on a monomeric bonding of a primary propylamine functionality to YMC's spherical, ultra pure, high surface area silica with a mean pore diameter of 12 nm. The amine functionality provides retention and allows the separation of polar compounds under aggressive normal phase elution conditions, e.g. the analysis of mono- and polysaccharides using acetonitrile/water eluents. (Since YMC-Pack NH₂ packings operate under normal phase / HILIC elution conditions, water, which is more polar than acetonitrile, is the stronger solvent.) YMC-Pack NH₂ (Amino) can also be used for the separation of isomers of tocopherols and other organic soluble compounds such as paraffins, olefins and aromatics under conventional normal phase conditions.

In aqueous, low pH buffers the amino phase becomes a weak anion exchanger capable of separating negatively charged molecules.

YMC-Pack NH₂ (Amino) is also available in preparative particle sizes.

Column care

YMC-Pack NH₂ (Amino) is stable towards hydrolysis between pH 2.0-7.5. Remove acid and buffer salts before storage.

For detailed information please refer to the "Column Care and Use Instructions" which can be downloaded from www.ymc.de.

YMC-Pack TMS (C1)



- intermediate polarity between normal phase silica and other alkyl bonded reversed phases
- operates in either normal phase or reversed phase mode

YMC-Pack TMS	Specification
Particle Size / μm	3; 5
Pore Size / nm	12
Surface area / m^2g^{-1}	330
Carbon content / %	4
Recommended pH range	2.0 - 7.5

General

YMC-Pack TMS (C1) is a bonded phase suitable for samples that exhibit strong retention characteristics and are difficult or impossible to separate on conventional reversed phase or normal phase packings.

Properties

YMC-Pack TMS (C1) is bonded with trimethylmonochlorosilane to create a phase with intermediate polarity for separation of extremely hydrophobic compounds using conventional reversed phase solvents and of highly polar compounds using normal phase solvents.

The chemistry of TMS is also well-suited for the analysis of multifunctional compounds. Selectivity characteristics of a C1 bonded phase can be unique, and samples must be tested to determine the applicability of the phase.

YMC-Pack TMS (C1) is also available in preparative particle sizes.

Column care

YMC-Pack TMS (C1) is stable towards hydrolysis between pH 2.0-7.5. Remove acid and buffer salts before storage. Store the column in methanol / water = 70/30. Clogged inlet frits often can be cleaned by changing the flow direction or replacement.

For detailed information please refer to the "Column Care and Use Instructions" which can be downloaded from www.ymc.de.

Ordering Information

YMC-Pack SIL

Phase dimension	Column ID [mm]	Column length [mm]					Guard cartridges* with 10 mm length [pack of 5]
		30 (WT) / 33 (QT)	50	100	150	250	
6 nm 3 µm	2.1	SL06S03-H3Q1QT	SL06S03-05Q1QT	SL06S03-10Q1QT	SL06S03-15Q1QT	SL06S03-25Q1QT	SL06S03-01Q1GC
	3.0	SL06S03-H303QT	SL06S03-0503QT	SL06S03-1003QT	SL06S03-1503QT	SL06S03-2503QT	SL06S03-0103GC
	4.0	SL06S03-H304QT	SL06S03-0504QT	SL06S03-1004QT	SL06S03-1504QT	SL06S03-2504QT	SL06S03-0104GC
	4.6	SL06S03-0346WT	SL06S03-0546WT	SL06S03-1046WT	SL06S03-1546WT	SL06S03-2546WT	SL06S03-0104GC
12 nm 3 µm	2.1	SL12S03-H3Q1QT	SL12S03-05Q1QT	SL12S03-10Q1QT	SL12S03-15Q1QT	SL12S03-25Q1QT	SL12S03-01Q1GC
	3.0	SL12S03-H303QT	SL12S03-0503QT	SL12S03-1003QT	SL12S03-1503QT	SL12S03-2503QT	SL12S03-0103GC
	4.0	SL12S03-H304QT	SL12S03-0504QT	SL12S03-1004QT	SL12S03-1504QT	SL12S03-2504QT	SL12S03-0104GC
	4.6	SL12S03-0346WT	SL12S03-0546WT	SL12S03-1046WT	SL12S03-1546WT	SL12S03-2546WT	SL12S03-0104GC
20 nm 3 µm	2.1	SL20S03-H3Q1QT	SL20S03-05Q1QT	SL20S03-10Q1QT	SL20S03-15Q1QT	SL20S03-25Q1QT	SL20S03-01Q1GC
	3.0	SL20S03-H303QT	SL20S03-0503QT	SL20S03-1003QT	SL20S03-1503QT	SL20S03-2503QT	SL20S03-0103GC
	4.0	SL20S03-H304QT	SL20S03-0504QT	SL20S03-1004QT	SL20S03-1504QT	SL20S03-2504QT	SL20S03-0104GC
	4.6	SL20S03-0346WT	SL20S03-0546WT	SL20S03-1046WT	SL20S03-1546WT	SL20S03-2546WT	SL20S03-0104GC
6 nm 5 µm	2.1	SL06S05-H3Q1QT	SL06S05-05Q1QT	SL06S05-10Q1QT	SL06S05-15Q1QT	SL06S05-25Q1QT	SL06S05-01Q1GC
	3.0	SL06S05-H303QT	SL06S05-0503QT	SL06S05-1003QT	SL06S05-1503QT	SL06S05-2503QT	SL06S05-0103GC
	4.0	SL06S05-H304QT	SL06S05-0504QT	SL06S05-1004QT	SL06S05-1504QT	SL06S05-2504QT	SL06S05-0104GC
	4.6	SL06S05-0346WT	SL06S05-0546WT	SL06S05-1046WT	SL06S05-1546WT	SL06S05-2546WT	SL06S05-0104GC
12 nm 5 µm	2.1	SL12S05-H3Q1QT	SL12S05-05Q1QT	SL12S05-10Q1QT	SL12S05-15Q1QT	SL12S05-25Q1QT	SL12S05-01Q1GC
	3.0	SL12S05-H303QT	SL12S05-0503QT	SL12S05-1003QT	SL12S05-1503QT	SL12S05-2503QT	SL12S05-0103GC
	4.0	SL12S05-H304QT	SL12S05-0504QT	SL12S05-1004QT	SL12S05-1504QT	SL12S05-2504QT	SL12S05-0104GC
	4.6	SL12S05-0346WT	SL12S05-0546WT	SL12S05-1046WT	SL12S05-1546WT	SL12S05-2546WT	SL12S05-0104GC
20 nm 5 µm	2.1	SL20S05-H3Q1QT	SL20S05-05Q1QT	SL20S05-10Q1QT	SL20S05-15Q1QT	SL20S05-25Q1QT	SL20S05-01Q1GC
	3.0	SL20S05-H303QT	SL20S05-0503QT	SL20S05-1003QT	SL20S05-1503QT	SL20S05-2503QT	SL20S05-0103GC
	4.0	SL20S05-H304QT	SL20S05-0504QT	SL20S05-1004QT	SL20S05-1504QT	SL20S05-2504QT	SL20S05-0104GC
	4.6	SL20S05-0346WT	SL20S05-0546WT	SL20S05-1046WT	SL20S05-1546WT	SL20S05-2546WT	SL20S05-0104GC
12 nm 5 µm	2.1	SL30S05-H3Q1QT	SL30S05-05Q1QT	SL30S05-10Q1QT	SL30S05-15Q1QT	SL30S05-25Q1QT	SL30S05-01Q1GC
	3.0	SL30S05-H303QT	SL30S05-0503QT	SL30S05-1003QT	SL30S05-1503QT	SL30S05-2503QT	SL30S05-0103GC
	4.0	SL30S05-H304QT	SL30S05-0504QT	SL30S05-1004QT	SL30S05-1504QT	SL30S05-2504QT	SL30S05-0104GC
	4.6	SL30S05-0346WT	SL30S05-0546WT	SL30S05-1046WT	SL30S05-1546WT	SL30S05-2546WT	SL30S05-0104GC

*Guard cartridge holder required, part no. XPGCH-Q1

YMC-Pack PVA-Sil

Phase dimension	Column ID [mm]	Column length [mm]					Guard cartridges* with 10 mm length [pack of 5]
		30 (WT) / 33 (QT)	50	100	150	250	
12 nm 5 µm	2.1	PV12S05-H3Q1QT	PV12S05-05Q1QT	PV12S05-10Q1QT	PV12S05-15Q1QT	PV12S05-25Q1QT	PV12S05-01Q1GC
	3.0	PV12S05-H303QT	PV12S05-0503QT	PV12S05-1003QT	PV12S05-1503QT	PV12S05-2503QT	PV12S05-0103GC
	4.0	PV12S05-H304QT	PV12S05-0504QT	PV12S05-1004QT	PV12S05-1504QT	PV12S05-2504QT	PV12S05-0104GC
	4.6	PV12S05-0346WT	PV12S05-0546WT	PV12S05-1046WT	PV12S05-1546WT	PV12S05-2546WT	PV12S05-0104GC

*Guard cartridge holder required, part no. XPGCH-Q1

YMC-Pack CN (Cyano)

Phase dimension	Column ID [mm]	Column length [mm]					Guard cartridges* with 10 mm length [pack of 5]
		30 (WT) / 33 (QT)	50	100	150	250	
12 nm 3 µm	2.1	CN12S03-H3Q1QT	CN12S03-05Q1QT	CN12S03-10Q1QT	CN12S03-15Q1QT	CN12S03-25Q1QT	CN12S03-01Q1GC
	3.0	CN12S03-H303QT	CN12S03-0503QT	CN12S03-1003QT	CN12S03-1503QT	CN12S03-2503QT	CN12S03-0103GC
	4.0	CN12S03-H304QT	CN12S03-0504QT	CN12S03-1004QT	CN12S03-1504QT	CN12S03-2504QT	CN12S03-0104GC
	4.6	CN12S03-0346WT	CN12S03-0546WT	CN12S03-1046WT	CN12S03-1546WT	CN12S03-2546WT	CN12S03-0104GC
12 nm 5 µm	2.1	CN12S05-H3Q1QT	CN12S05-05Q1QT	CN12S05-10Q1QT	CN12S05-15Q1QT	CN12S05-25Q1QT	CN12S05-01Q1GC
	3.0	CN12S05-H303QT	CN12S05-0503QT	CN12S05-1003QT	CN12S05-1503QT	CN12S05-2503QT	CN12S05-0103GC
	4.0	CN12S05-H304QT	CN12S05-0504QT	CN12S05-1004QT	CN12S05-1504QT	CN12S05-2504QT	CN12S05-0104GC
	4.6	CN12S05-0346WT	CN12S05-0546WT	CN12S05-1046WT	CN12S05-1546WT	CN12S05-2546WT	CN12S05-0104GC
30 nm 5 µm	2.1	CN30S05-H3Q1QT	CN30S05-05Q1QT	CN30S05-10Q1QT	CN30S05-15Q1QT	CN30S05-25Q1QT	CN30S05-01Q1GC
	3.0	CN30S05-H303QT	CN30S05-0503QT	CN30S05-1003QT	CN30S05-1503QT	CN30S05-2503QT	CN30S05-0103GC
	4.0	CN30S05-H304QT	CN30S05-0504QT	CN30S05-1004QT	CN30S05-1504QT	CN30S05-2504QT	CN30S05-0104GC
	4.6	CN30S05-0346WT	CN30S05-0546WT	CN30S05-1046WT	CN30S05-1546WT	CN30S05-2546WT	CN30S05-0104GC

*Guard cartridge holder required, part no. XPGCH-Q1

Ordering Information

YMC-Pack Diol-NP

Phase dimension	Column ID [mm]	Column length [mm]					Guard cartridges* with 10 mm length [pack of 5]
		30 (WT) / 33 (QT)	50	100	150	250	
6 nm 5 µm	2.1	DN06S05-H3Q1QT	DN06S05-05Q1QT	DN06S05-10Q1QT	DN06S05-15Q1QT	DN06S05-25Q1QT	DN06S05-01Q1GC
	3.0	DN06S05-H303QT	DN06S05-0503QT	DN06S05-1003QT	DN06S05-1503QT	DN06S05-2503QT	DN06S05-0103GC
	4.0	DN06S05-H304QT	DN06S05-0504QT	DN06S05-1004QT	DN06S05-1504QT	DN06S05-2504QT	DN06S05-0104GC
	4.6	DN06S05-0346WT	DN06S05-0546WT	DN06S05-1046WT	DN06S05-1546WT	DN06S05-2546WT	DN06S05-0104GC
12 nm 5 µm	2.1	DN12S05-H3Q1QT	DN12S05-05Q1QT	DN12S05-10Q1QT	DN12S05-15Q1QT	DN12S05-25Q1QT	DN12S05-01Q1GC
	3.0	DN12S05-H303QT	DN12S05-0503QT	DN12S05-1003QT	DN12S05-1503QT	DN12S05-2503QT	DN12S05-0103GC
	4.0	DN12S05-H304QT	DN12S05-0504QT	DN12S05-1004QT	DN12S05-1504QT	DN12S05-2504QT	DN12S05-0104GC
	4.6	DN12S05-0346WT	DN12S05-0546WT	DN12S05-1046WT	DN12S05-1546WT	DN12S05-2546WT	DN12S05-0104GC
20 nm 5 µm	2.1	DN20S05-H3Q1QT	DN20S05-05Q1QT	DN20S05-10Q1QT	DN20S05-15Q1QT	DN20S05-25Q1QT	DN20S05-01Q1GC
	3.0	DN20S05-H303QT	DN20S05-0503QT	DN20S05-1003QT	DN20S05-1503QT	DN20S05-2503QT	DN20S05-0103GC
	4.0	DN20S05-H304QT	DN20S05-0504QT	DN20S05-1004QT	DN20S05-1504QT	DN20S05-2504QT	DN20S05-0104GC
	4.6	DN20S05-0346WT	DN20S05-0546WT	DN20S05-1046WT	DN20S05-1546WT	DN20S05-2546WT	DN20S05-0104GC
30 nm 5 µm	2.1	DN30S05-H3Q1QT	DN30S05-05Q1QT	DN30S05-10Q1QT	DN30S05-15Q1QT	DN30S05-25Q1QT	DN30S05-01Q1GC
	3.0	DN30S05-H303QT	DN30S05-0503QT	DN30S05-1003QT	DN30S05-1503QT	DN30S05-2503QT	DN30S05-0103GC
	4.0	DN30S05-H304QT	DN30S05-0504QT	DN30S05-1004QT	DN30S05-1504QT	DN30S05-2504QT	DN30S05-0104GC
	4.6	DN30S05-0346WT	DN30S05-0546WT	DN30S05-1046WT	DN30S05-1546WT	DN30S05-2546WT	DN30S05-0104GC

*Guard cartridge holder required, part no. XPGCH-Q1

YMC-Pack Polyamine II

Phase dimension	Column ID [mm]	Column length [mm]					Guard cartridges* with 10 mm length [pack of 5]
		30 (WT) / 33 (QT)	50	100	150	250	
12 nm 5 µm	2.1	PB12S05-H3Q1QT	PB12S05-05Q1QT	PB12S05-10Q1QT	PB12S05-15Q1QT	PB12S05-25Q1QT	PB12S05-01Q1GC
	3.0	PB12S05-H303QT	PB12S05-0503QT	PB12S05-1003QT	PB12S05-1503QT	PB12S05-2503QT	PB12S05-0103GC
	4.0	PB12S05-H304QT	PB12S05-0504QT	PB12S05-1004QT	PB12S05-1504QT	PB12S05-2504QT	PB12S05-0104GC
	4.6	PB12S05-0346WT	PB12S05-0546WT	PB12S05-1046WT	PB12S05-1546WT	PB12S05-2546WT	PB12S05-0104GC

*Guard cartridge holder required, part no. XPGCH-Q1

YMC-Pack NH₂ (Amino)

Phase dimension	Column ID [mm]	Column length [mm]					Guard cartridges* with 10 mm length [pack of 5]
		30 (WT) / 33 (QT)	50	100	150	250	
12 nm 3 µm	2.1	NH12S03-H3Q1QT	NH12S03-05Q1QT	NH12S03-10Q1QT	NH12S03-15Q1QT	NH12S03-25Q1QT	NH12S03-01Q1GC
	3.0	NH12S03-H303QT	NH12S03-0503QT	NH12S03-1003QT	NH12S03-1503QT	NH12S03-2503QT	NH12S03-0103GC
	4.0	NH12S03-H304QT	NH12S03-0504QT	NH12S03-1004QT	NH12S03-1504QT	NH12S03-2504QT	NH12S03-0104GC
	4.6	NH12S03-0346WT	NH12S03-0546WT	NH12S03-1046WT	NH12S03-1546WT	NH12S03-2546WT	NH12S03-0104GC
12 nm 5 µm	2.1	NH12S05-H3Q1QT	NH12S05-05Q1QT	NH12S05-10Q1QT	NH12S05-15Q1QT	NH12S05-25Q1QT	NH12S05-01Q1GC
	3.0	NH12S05-H303QT	NH12S05-0503QT	NH12S05-1003QT	NH12S05-1503QT	NH12S05-2503QT	NH12S05-0103GC
	4.0	NH12S05-H304QT	NH12S05-0504QT	NH12S05-1004QT	NH12S05-1504QT	NH12S05-2504QT	NH12S05-0104GC
	4.6	NH12S05-0346WT	NH12S05-0546WT	NH12S05-1046WT	NH12S05-1546WT	NH12S05-2546WT	NH12S05-0104GC

*Guard cartridge holder required, part no. XPGCH-Q1

YMC-Pack TMS (C1)

Phase dimension	Column ID [mm]	Column length [mm]					Guard cartridges* with 10 mm length [pack of 5]
		30 (WT) / 33 (QT)	50	100	150	250	
12 nm 3 µm	2.1	TM12S03-H3Q1QT	TM12S03-05Q1QT	TM12S03-10Q1QT	TM12S03-15Q1QT	TM12S03-25Q1QT	TM12S03-01Q1GC
	3.0	TM12S03-H303QT	TM12S03-0503QT	TM12S03-1003QT	TM12S03-1503QT	TM12S03-2503QT	TM12S03-0103GC
	4.0	TM12S03-H304QT	TM12S03-0504QT	TM12S03-1004QT	TM12S03-1504QT	TM12S03-2504QT	TM12S03-0104GC
	4.6	TM12S03-0346WT	TM12S03-0546WT	TM12S03-1046WT	TM12S03-1546WT	TM12S03-2546WT	TM12S03-0104GC
12 nm 5 µm	2.1	TM12S05-H3Q1QT	TM12S05-05Q1QT	TM12S05-10Q1QT	TM12S05-15Q1QT	TM12S05-25Q1QT	TM12S05-01Q1GC
	3.0	TM12S05-H303QT	TM12S05-0503QT	TM12S05-1003QT	TM12S05-1503QT	TM12S05-2503QT	TM12S05-0103GC
	4.0	TM12S05-H304QT	TM12S05-0504QT	TM12S05-1004QT	TM12S05-1504QT	TM12S05-2504QT	TM12S05-0104GC
	4.6	TM12S05-0346WT	TM12S05-0546WT	TM12S05-1046WT	TM12S05-1546WT	TM12S05-2546WT	TM12S05-0104GC

*Guard cartridge holder required, part no. XPGCH-Q1

For other dimensions please refer to page 352-353





YMC Phases for Biochromatography

Contents

Selection Guide for Biochromatography	184-185
Ion Exchange (IEX)	187-198
YMC-BioPro QA/SP (porous)	190-191
YMC-BioPro QA-F/SP-F (non-porous)	192-194
YMC-BioPro Q75/S75 (prep. example)	195
Preparative Screening Kits	196
Ordering Information (columns and prep. bulk)	197-198
 Size Exclusion (SEC)	199-212
General	200
SEC Applications for YMC-Pack Diol	201-202
High flexibility / Scalability	203
Reproducibility	204
SEC Applications for YMC-Pack Diol	205-211
Ordering Information	212
Reversed Phase (RP)	213-223
General	214-215
Applications	216-221
Ordering Information	222-224
Normal Phase / HILIC (NP/HILIC)	225-228
General	226
YMC-Pack Polyamine II	227-228
Ordering Information	228
Glass Columns.....	229-240
YMC ECO Series	230-231
Ordering Guide	232-233
Ordering information for ECO packing adaptors	234
YMC ECO ^{PLUS} Series	235-238
Ordering information for ECO ^{PLUS} packing adaptors	239
Ordering guide	240
Pilot Glass and DAU Columns	241

Introduction

HPLC Columns for Biochromatography

Historically, small molecules have played the major role in diagnosis and therapy. However with the recent developments in the fields of genomics, proteomics and metabolomics, biological molecules have become an important tool for the treatment of diseases or for help in the understanding of biological processes.

YMC has always played an important role in the provision of materials for bioseparations. With the constant driving force of innovation, the focus has always been on column design and stationary phase manufacturing. As a consequence, YMC offers state-of-the-art reversed phase, ion-exchange, size exclusion and normal phase/HILIC columns and bulk materials.

Proteins, Peptides

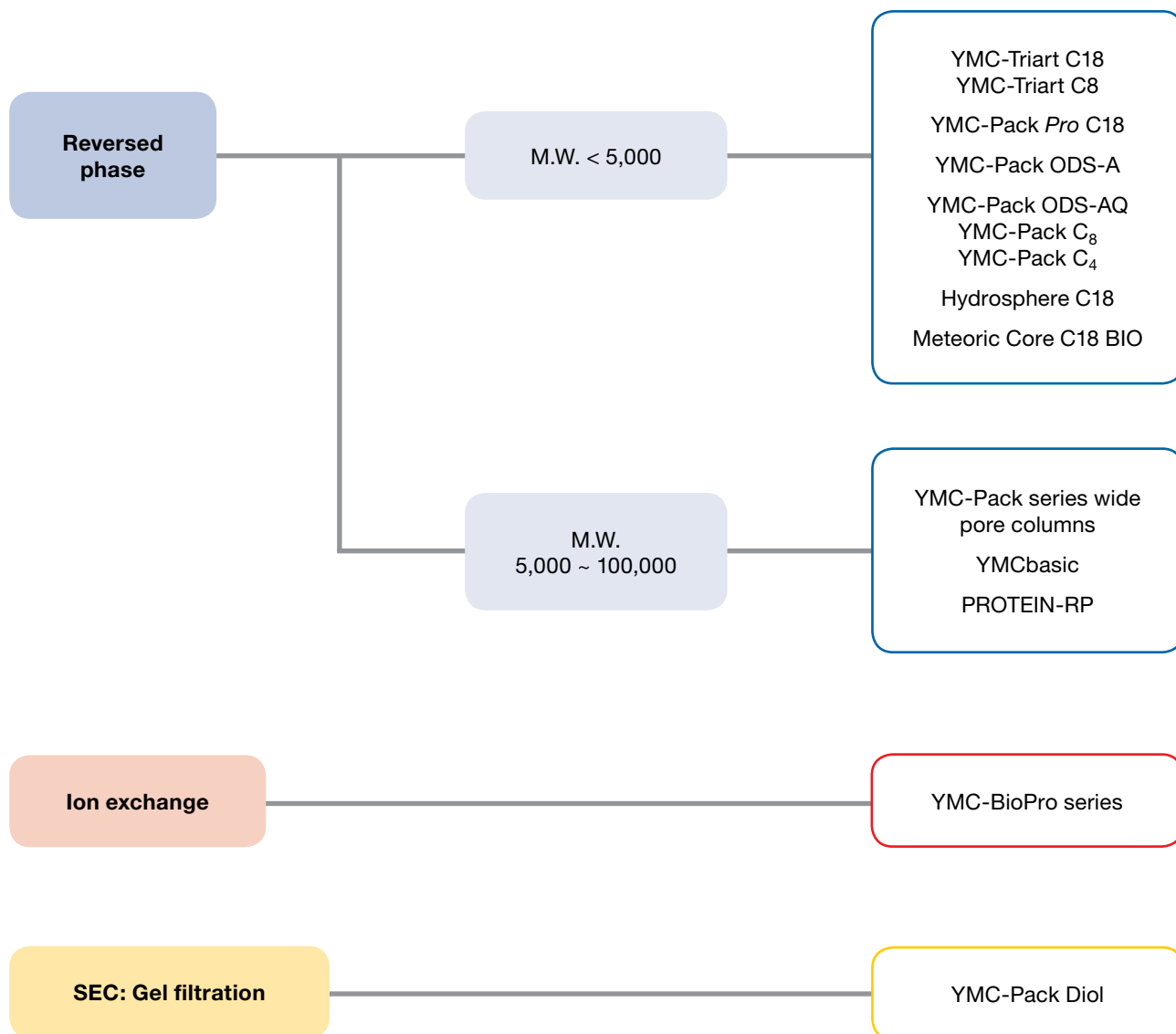

Nucleic acids

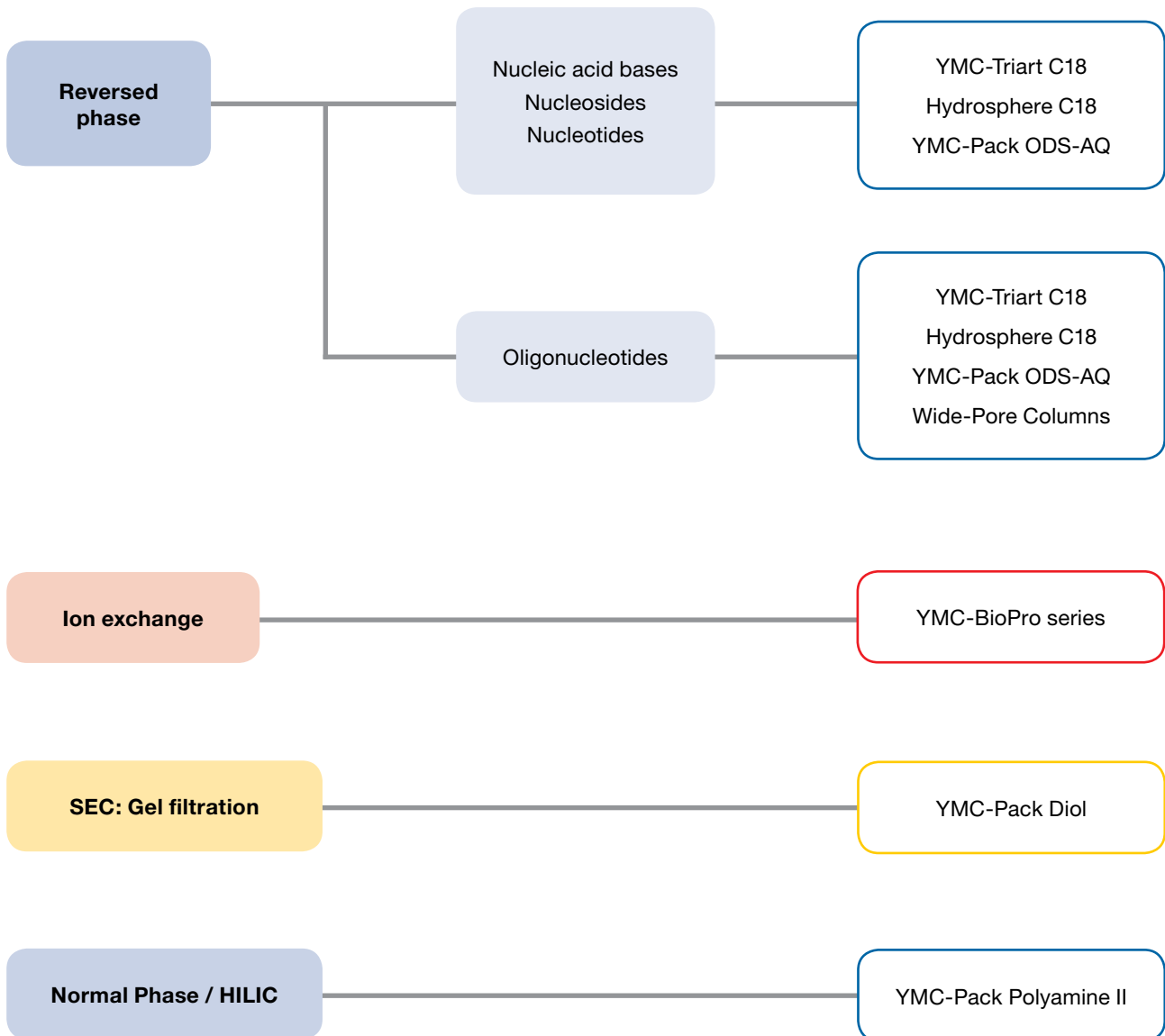

Polysaccharides



Determination of DBC*

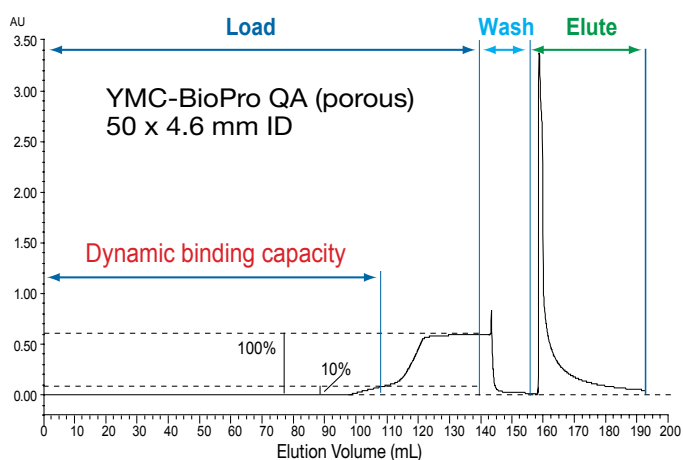

* Application data by courtesy YMC Co., Ltd.

Before determination, equilibrate the column with equilibration buffer.

Step 1: Load

A protein solution of known concentration is continuously loaded at the desired flow rate and the absorbance of the eluate is monitored until full saturation is achieved (100% UV absorbance of the pure sample solutions).

Step 2: Wash

Wash the column with equilibration buffer until no more protein elutes (0% UV absorbance).

Step 3: Elute

The DBC of the medium is a measure of the volume of protein solution that has been applied up to a specific breakthrough point (usually 5 or 10%).

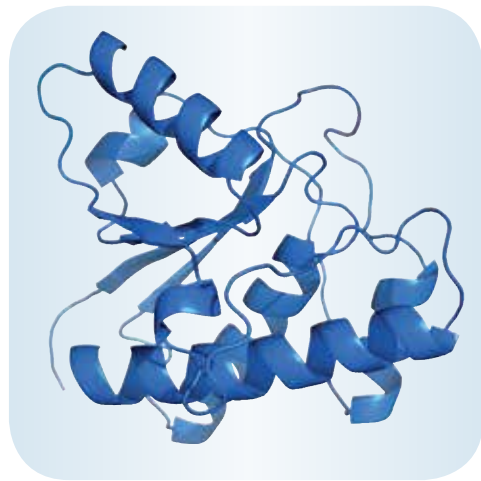
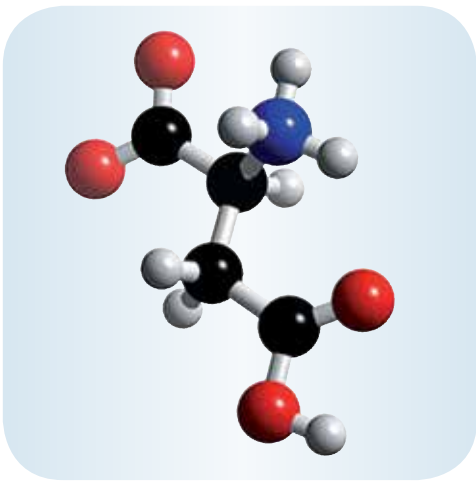

IEX

YMC-BioPro series

- porous or non-porous hydrophilic polymers with low nonspecific adsorption
- excellent binding capacity and recovery of biomolecules
- very high resolution
- also available as bulk media in 10, 30 and 75 μm



YMC-BioPro Series	YMC-BioPro QA	YMC-BioPro SP
Matrix	porous polymer beads	porous polymer beads
Pore size / nm	100	100
Particle size / μm	5	5
Charged group	$-\text{CH}_2\text{N}^+(\text{CH}_3)_3$	$-(\text{CH}_2)_3\text{SO}_3^-$
Counter ion	Cl^-	Na^+
Available pH range	2.0 - 12.0	2.0 - 12.0

Also available in 10, 30 and 75 μm for preparative scale

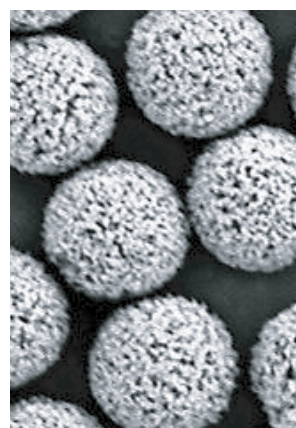

Porous polymer beads

YMC-BioPro Series	YMC-BioPro QA-F	YMC-BioPro SP-F
Matrix	non-porous polymer beads	non-porous polymer beads
Pore size / nm	non-porous	non-porous
Particle size / μm	3; 5	3; 5
Charged group	$-\text{CH}_2\text{N}^+(\text{CH}_3)_3$	$-(\text{CH}_2)_3\text{SO}_3^-$
Counter ion	Cl^-	Na^+
Available pH range	2.0 - 12.0	2.0 - 12.0

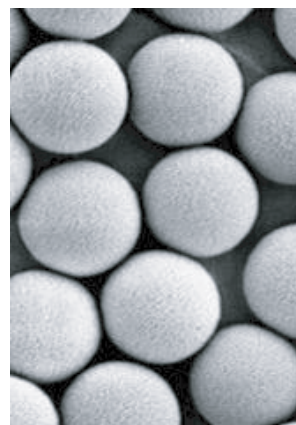

Nonporous polymer beads

General

YMC-BioPro series ion exchange columns are available in QA and SP chemistries, based on 5 μm porous (QA or SP columns) or on 3 or 5 μm non-porous (QA-F and SP-F columns) hydrophilic polymer beads. The porous materials offer excellent binding capacity with unusually high efficiency and low operating pressure, while the non-porous particles offer high efficiency, exceptional resolution and low operating pressures.

YMC-BioPro series

High binding capacity and high recovery for porous type

The porous versions of YMC-BioPro show high dynamic binding capacity and excellent recovery, making them useful for semi-preparative separations of proteins and antibodies.

Comparison of dynamic binding capacity (DBC) for BSA

	Dynamic binding capacity (mg/mL-gel, 10% breakthrough)	Eluted amount (mg/mL-gel)	Recovery* (%)
YMC-BioPro QA	126	120	95
Mono Q (GE Healthcare)	100	35	35
BioAssist Q (Tosoh Bioscience)	73	58	79

* Recovery: (Eluted amount/Dynamic binding capacity) x 100

Compared with conventional porous polymer anion exchange columns, YMC-BioPro QA gives higher DBC and recovery rates. This indicates that YMC-BioPro has a much lower nonspecific adsorption compared to conventional columns.

High recovery rates for YMC-BioPro

Superior resolution

Comparison of standard protein separation on YMC-BioPro SP and commercial SP or S type products*

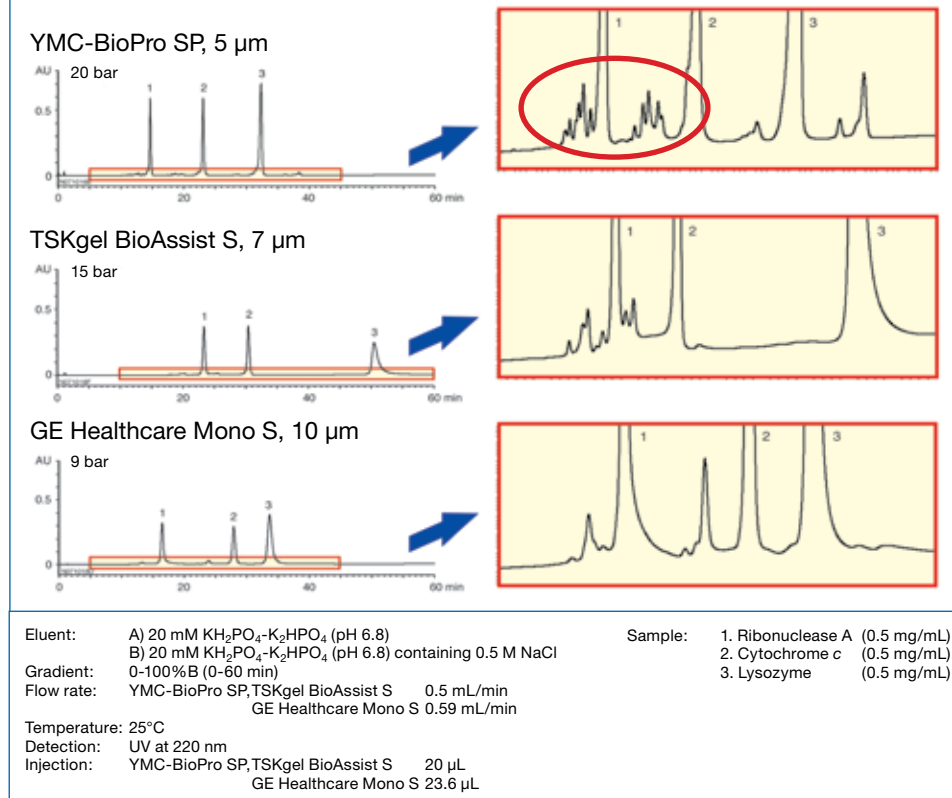

Superior resolution

YMC-BioPro only is available in smaller particle size and therefore provides superior resolution.

YMC-BioPro QA/SP

Applications for porous YMC-BioPro

Loading study for YMC-BioPro QA (porous) – Proteins*

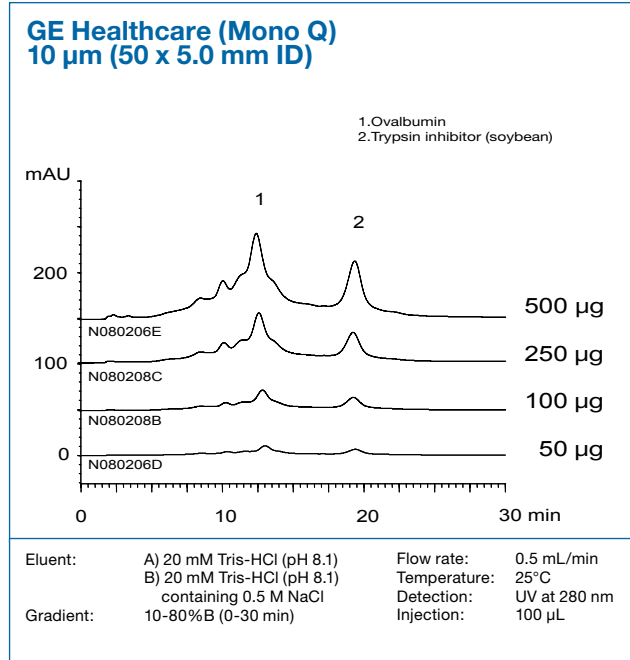
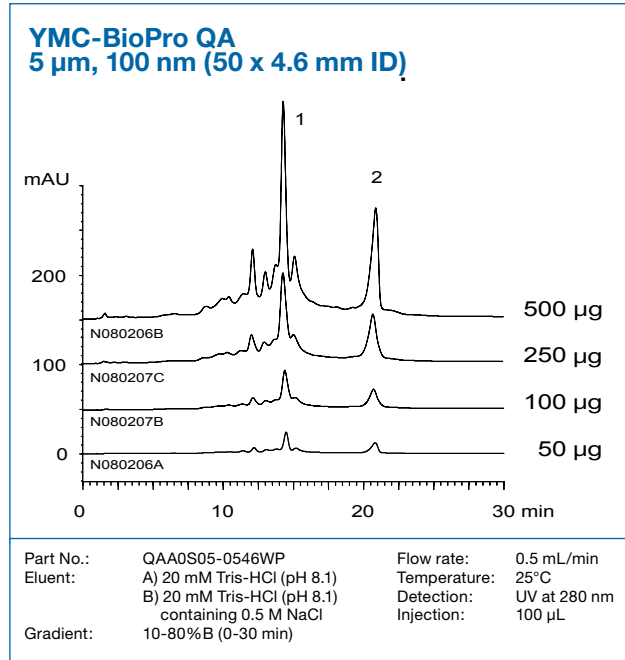

Peptide mapping*

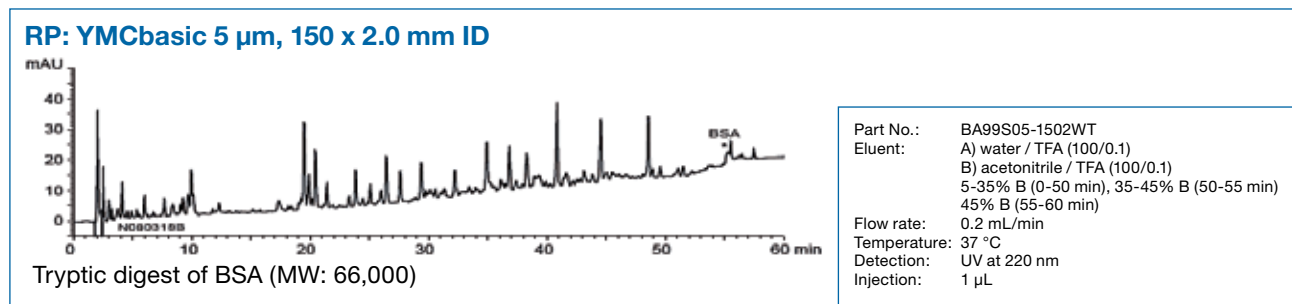
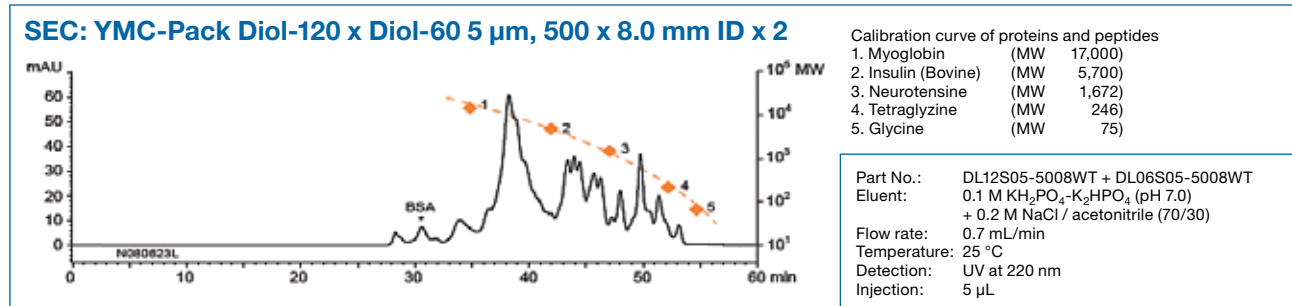
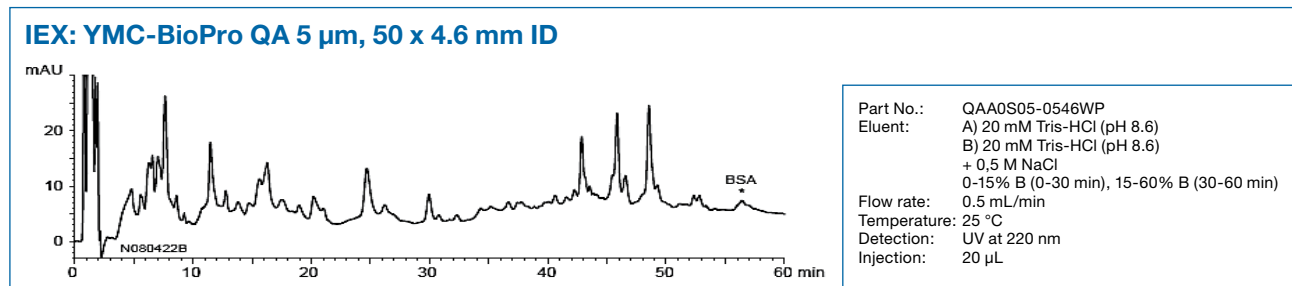

YMC-BioPro QA/SP

Peptide mapping of tryptic digest of BSA*

YMC-BioPro QA
5 µm, 50 x 4.6 mm ID

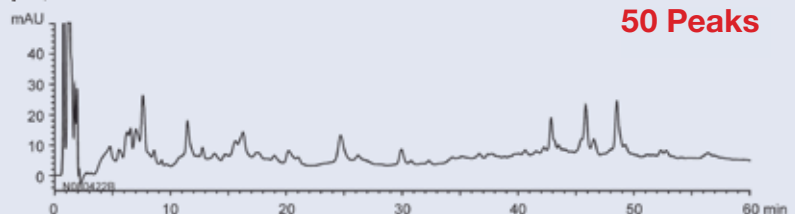

TSKgel BioAssist Q
10 µm, 50 x 4.6 mm ID

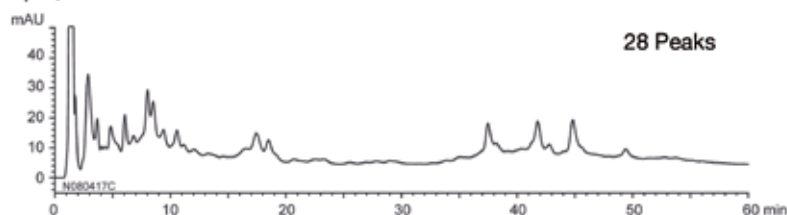

Mono Q
10 µm, 50 x 5.0 mm ID

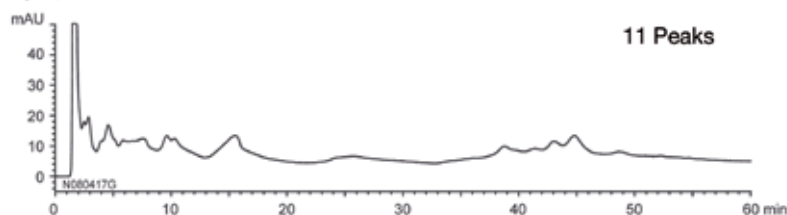

Eluent: A) 20 mM Tris-HCl (pH 8.6)
B) 20 mM Tris-HCl (pH 8.6) containing 0.5 M NaCl
Gradient: 0-15%B (0-30 min), 15-60%B (30-60 min)
Flow rate: 0.5 mL/min
Temperature: 25°C
Detection: UV at 220 nm
Injection: 20 µL
Sample: Tryptic digest of BSA

Separation of proteins in human serum on YMC-BioPro QA and commercial Q type products*

YMC-BioPro QA
5 µm, 50 x 4.6 mm ID

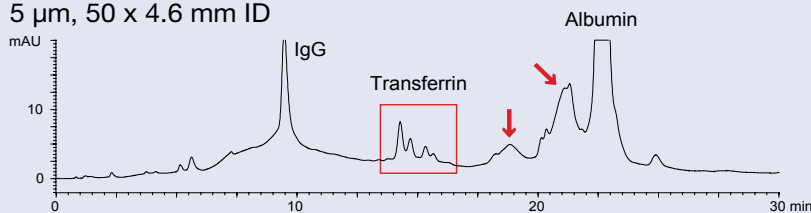

TSKgel BioAssist Q
10 µm, 50 x 4.6 mm ID

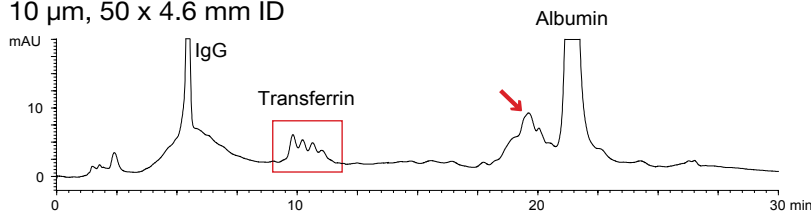

GE Healthcare Mono Q
10 µm, 50 x 5.0 mm ID

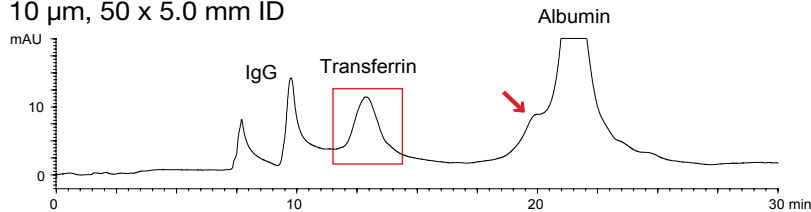

Eluent : A) 20 mM Tris-HCl (pH 8.6)
B) 20 mM Tris-HCl (pH 8.6) containing 0.5 M NaCl
Gradient : 0-30%B (0-15 min), 30-100%B (15-30 min)
Flow rate : 0.5 mL/min
Temperature: 25 °C
Detection : UV at 280 nm
Injection : 20 µL
Sample : Human serum (100 µL/mL)

For high resolution YMC-BioPro QA/SP, porous IEX material, is recommended!

YMC-BioPro QA-F/SP-F

Applications for non-porous YMC-BioPro: High Throughput IEX

Comparison of standard protein separation on YMC-BioPro SP-F and a commercial SP-type product*

high plate count

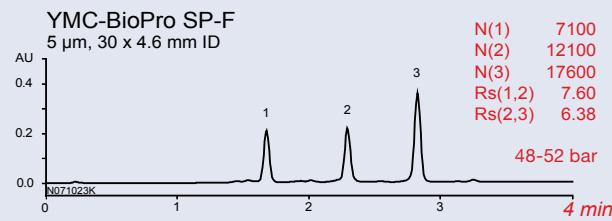

YMC-BioPro SP-F elutes the proteins as sharper peaks without peak-tailing than TSKgel SP-NPR.

Despite the larger particle size, the theoretical plate count for YMC-BioPro SP-F is higher than that for TSKgel SP-NPR.

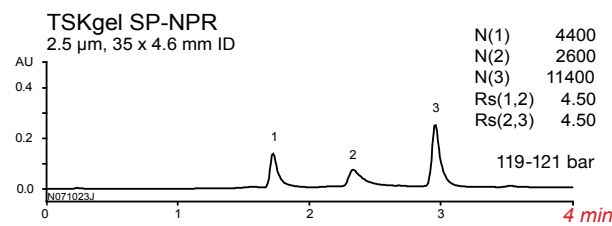

Eluent: A) 20 mM KH_2PO_4 - K_2HPO_4 (pH 6.8)
B) 20 mM KH_2PO_4 - K_2HPO_4 (pH 6.8) containing 0.5 M NaCl
Gradient: YMC-BioPro SP-F 0-100%B (0-4 min)
TSKgel SP-NPR 0-100%B (0-4.67 min)
Flow rate: 1.5 mL/min
Temperature: 25°C
Detection: UV at 220 nm
Injection: 20 μ L
Sample: 1. Ribonuclease A (0.1 mg/mL)
2. Cytochrome c (0.1 mg/mL)
3. Lysozyme (0.1 mg/mL)

Compared to the competitor's column, YMC-BioPro SP-F show higher theoretical plate counts, excellent peak shapes, and lower backpressure. This makes YMC-BioPro SP-F most suitable for high-throughput analysis.

MAb analysis on non-porous YMC-BioPro QA-F*

Comparison of 30 mm-length and 100 mm-length

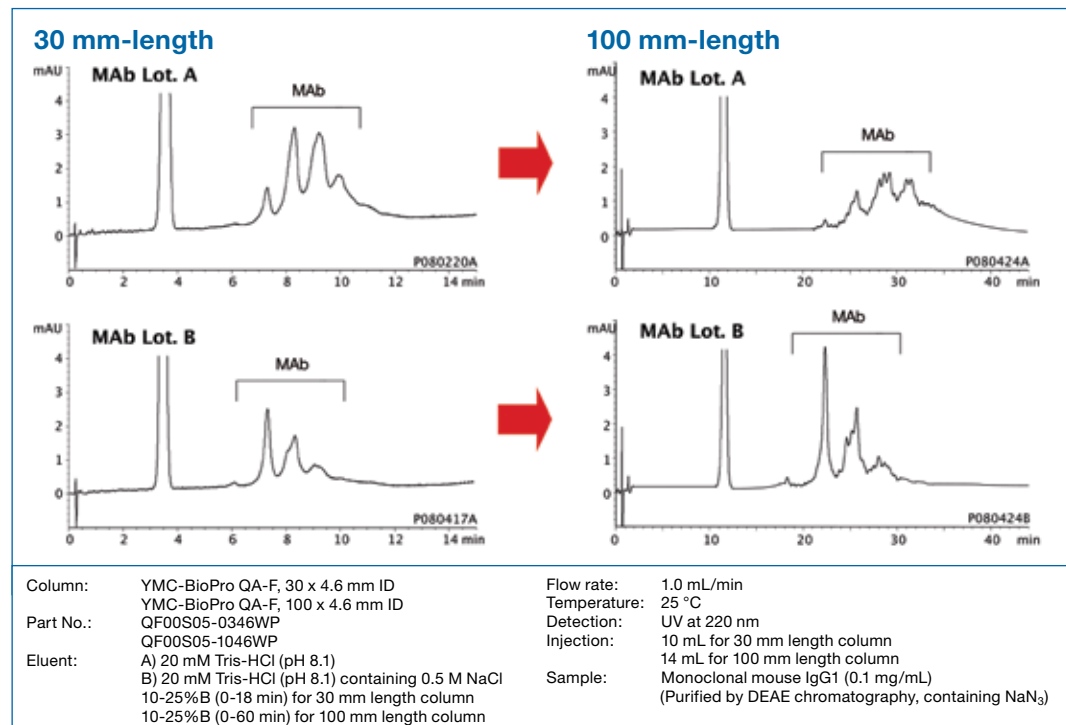

Two different lots of commercially available MAb, purified by DEAE chromatography, are separated on 30 mm and 100 mm length of YMC-BioPro QA-F columns. The lot-to-lot variability of MAb is observed and the resolution is increased on 100 mm-length column.

YMC-BioPro QA-F/SP-F

Applications for non-porous YMC-BioPro: High Resolution IEX

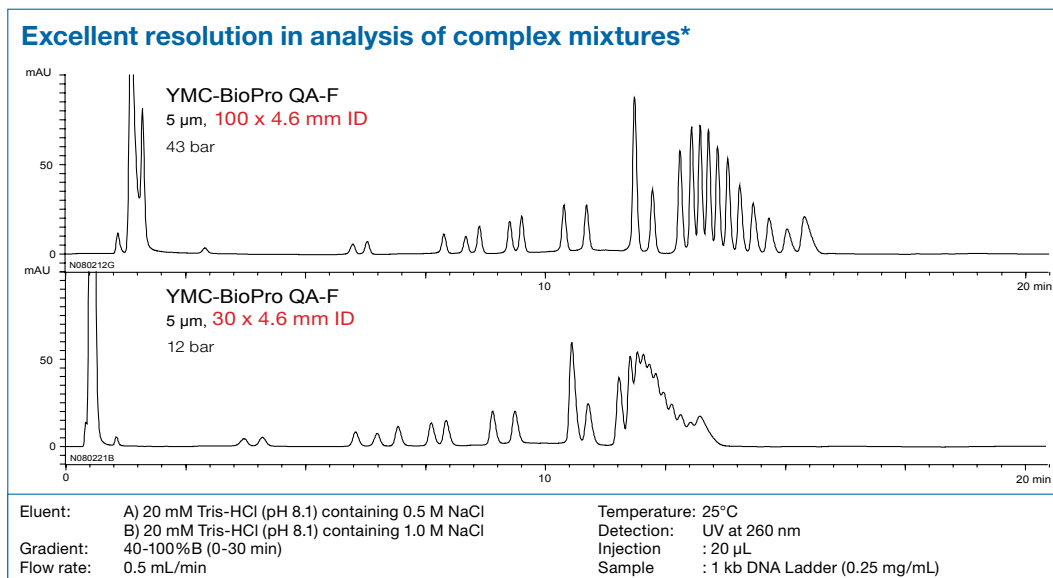
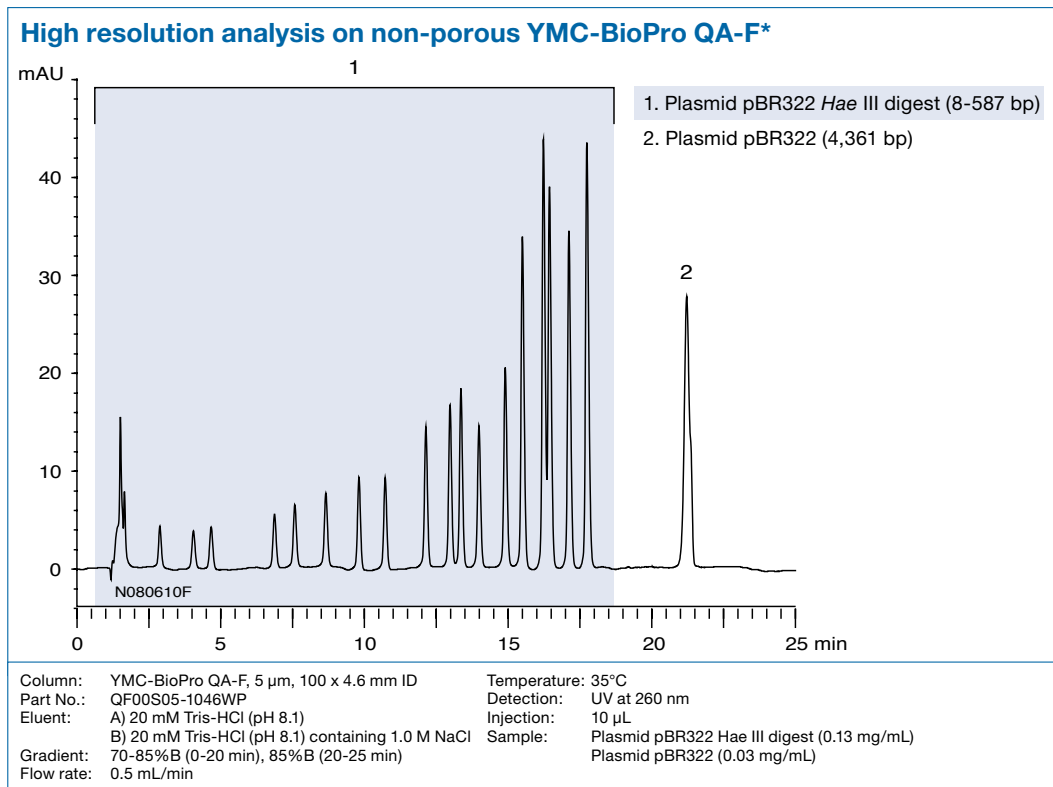

Comparison of DNA fragment separation on 100 mm and 30 mm length YMC-BioPro QA-F columns.

YMC-BioPro QA-F/SP-F

MAb analysis on non-porous type cation-exchange columns*

Comparison of SCX (YMC-BioPro SP-F) and WCX (ProPac WCX-10) under the same gradient condition

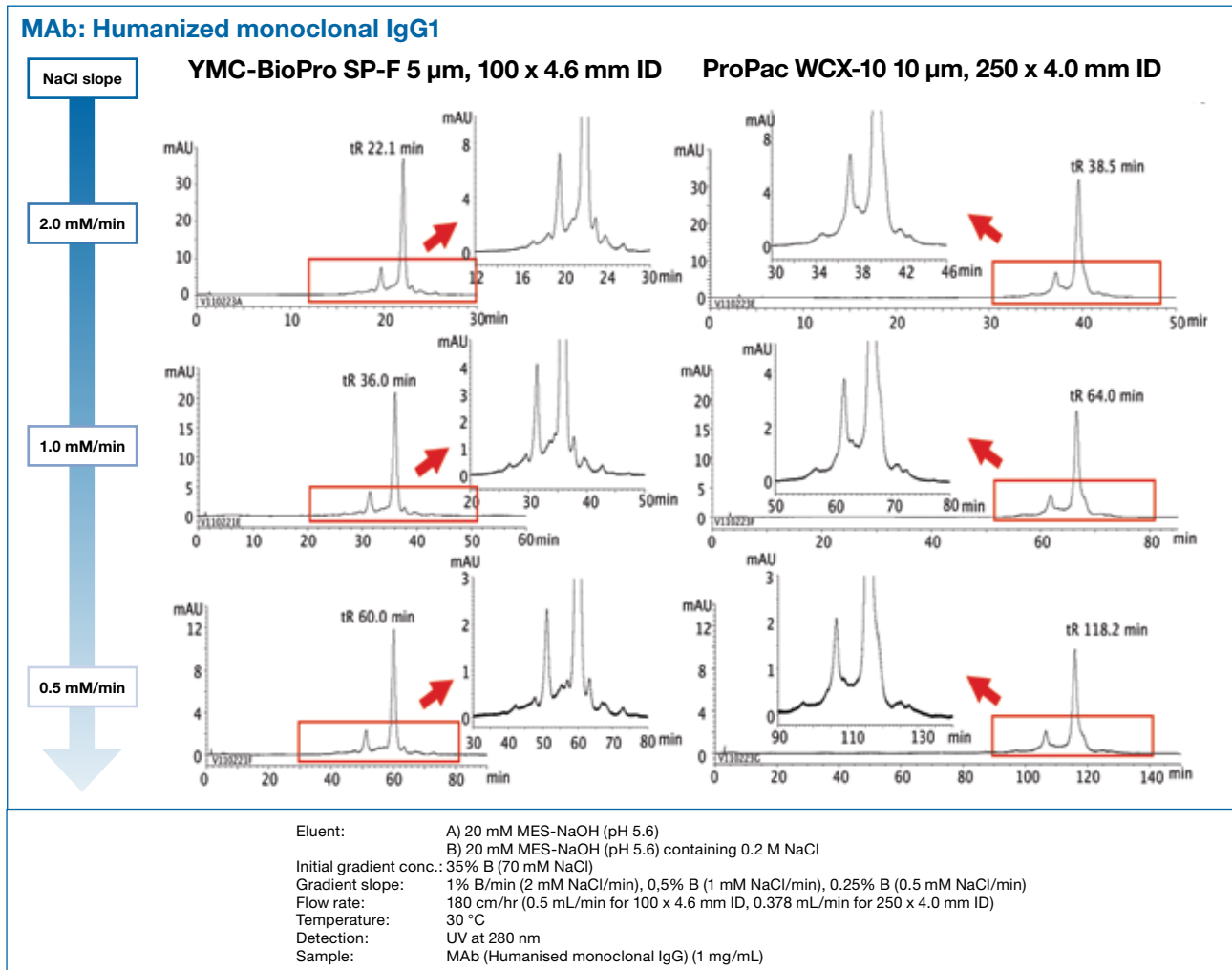

The separation of MAb is compared on SCX (YMC-BioPro SP-F) and WCX (ProPac WCX-10) under the same gradient conditions at pH 5.6. The lower NaCl slope results in better resolution of minor peaks of MAb. YMC-BioPro SP-F can achieve the higher resolution of MAb than the competitor column under any conditions.

YMC-BioPro Q75/S75

Capture purification by ion-exchange chromatography (IEX)

Two step purification of IgY to produce reference standard material from crude egg yolk extract*

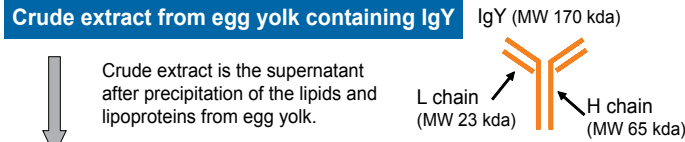

Step 1: Capture purification by ion-exchange chromatography (IEX) **Step 2: Final purification by size-exclusion chromatography (SEC)**

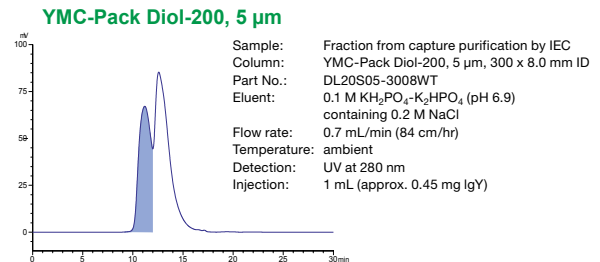
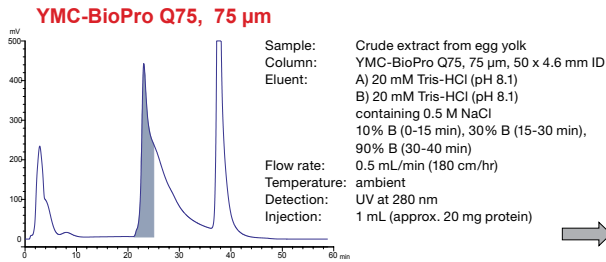

SDS-PAGE analysis of crude and purified fraction

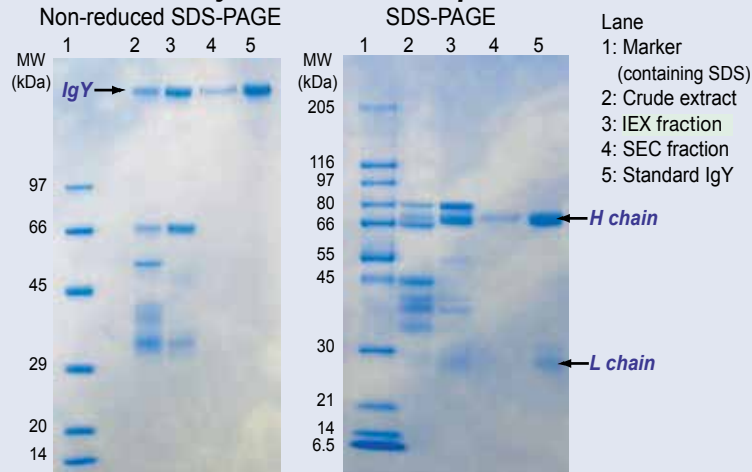

SEC analysis of crude and purified fraction

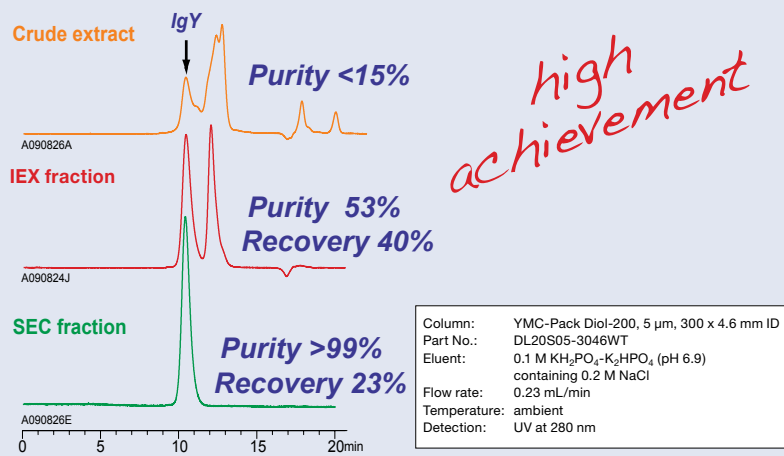

Preparative Screening Kits

The YMC-BioPro Ion Exchange Screening Kits consist of columns that are packed with resins designed for the separation of proteins, nucleotides, and other biomolecules. The various types of kit offer significant advantages and efficiencies for resin screening and purification method development.

Laboratory scale column sizes

1 mL Type (26 x 7.0 mm ID)



- Resin screening
- Purification method development

5 mL Type (26 x 15.6 mm ID)



- Purification method development
- Loadability studies

Specification

	Strong Anion Exchanger YMC-BioPro (SmartSep) Q	Strong Cation Exchanger YMC-BioPro (SmartSep) S	Weak Anion Exchanger YMC-BioPro DA	Weak Cation Exchanger YMC-BioPro CM
Matrix	Porous hydrophilic polymer		Porous methacrylate polymer	
Particle size (µm)	30, 75	30, 75	60	60
Ion exchanger	$-\text{CH}_2\text{N}^+(\text{CH}_3)_3$	$-\text{CH}_2\text{CH}_2\text{CH}_2\text{CH}_2\text{SO}_3^-$	$-\text{R}-\text{N}(\text{CH}_3)_2$	$-\text{R}-\text{COOH}$
pH range	2 - 12	2 - 12	Regular use: 3 - 12 Short term: 1 - 13	Regular use: 3 - 12 Short term: 1 - 13

Ordering information

3 µm analytical columns

Phase	Column ID [mm]	Column length [mm]		
		30	50	100
YMC-BioPro QA-F	4.6	QF00S03-0346WP	QF00S03-0546WP	QF00S03-1046WP
YMC-BioPro SP-F	4.6	SF00S03-0346WP	SF00S03-0546WP	SF00S03-1046WP

5 µm analytical columns

Phase	Column ID [mm]	Column length [mm]		
		30	50	100
YMC-BioPro QA	4.6	—	QAA0S05-0546WP	QAA0S05-1046WP
YMC-BioPro SP	4.6	—	SPA0S05-0546WP	SPA0S05-1046WP
YMC-BioPro QA-F	4.6	QF00S05-0346WP	QF00S05-0546WP	QF00S05-1046WP
YMC-BioPro SP-F	4.6	SF00S05-0346WP	SF00S05-0546WP	SF00S05-1046WP

Other dimensions on demand

Bulk media, strong exchangers

Phase	Particle Size	Part No.
YMC-BioPro SmartSep Q10	10 µm	QSA0S10
YMC-BioPro SmartSep S10	10 µm	SSA0S10
YMC-BioPro SmartSep Q30	30 µm	QSA0S30
YMC-BioPro SmartSep S30	30 µm	SSA0S30
YMC-BioPro Q75	75 µm	QAA0S75
YMC-BioPro S75	75 µm	SPA0S75

Conventional YMC-BioPro Q10/S10 (QAA0S10/SPA0S10) and Q30/S30 (QAA0S30/SPA0S30) available on request.

Bulk media, weak exchangers

Phase	Particle Size	Part No.
YMC-BioPro DA60	60 µm	DAM99S60
YMC-BioPro CM60	60 µm	CMM9960

For further information about YMC-BioPro bulk media please refer to page 318-322.

Ordering information

Preparative Screening Kits

Product name	Particle Size	Specification	Column volume	Product number
Ion Exchange Selection Kit (YMC-BioPro Q75/S75/DA60/CM60)	75 µm / 60 µm	1 each of 4 phases	1 mL	BPIESKS99-01PK
YMC-BioPro Q75	75 µm	pack of 5	1 mL 5 mL	BPQAA0S75-01PK BPQAA0S75-05PK
YMC-BioPro SmartSep Q30	30 µm	pack of 5	1 mL 5 mL	BPQSA0S30-01PK BPQSA0S30-05PK
YMC-BioPro S75	75 µm	pack of 5	1 mL 5 mL	BPSPA0S75-01PK BPSPA0S75-05PK
YMC-BioPro SmartSep S30	30 µm	pack of 5	1 mL 5 mL	BPSSA0S30-01PK BPSSA0S30-05PK
YMC-BioPro DA60	60 µm	pack of 5	1 mL 5 mL	BPDAM99S60-01PK BPDAM99S60-05PK
YMC-BioPro CM60	60 µm	pack of 5	1 mL 5 mL	BPCMM99S60-01PK BPCMM99S60-05PK

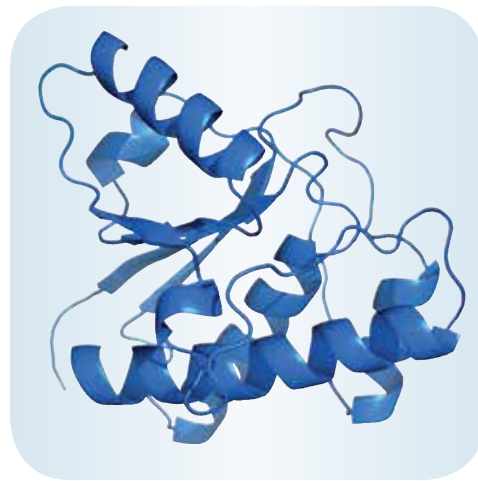
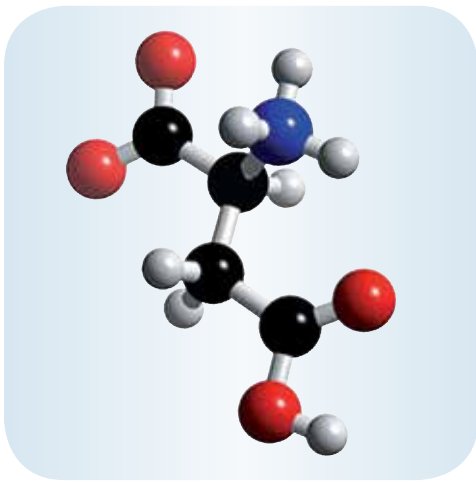

SEC

YMC-Pack Diol

What is special about YMC SEC columns?

- applicable to proteins, peptides, carbohydrates and nucleic acid components
- scalability from 3 μm to 20 μm
- reproducibility with minimal secondary interactions
- cost-efficiency



YMC-Pack Diol	Diol-60 for peptides and small proteins	Diol-120 for intermediate proteins	Diol-200 for large proteins	Diol-300 for very large proteins
Particle Size / μm	3; 5	3; 5	3; 5	3; 5
Pore Size / nm	6	12	20	30
Surface area / m^2g^{-1}	450	330	175	100
Recommended pH range	5.0 - 7.5	5.0 - 7.5	5.0 - 7.5	5.0 - 7.5

Principles of separation

Molecules with shapes such as rigid rods, random chains and spheres but with the same molecular weight behave differently in SEC. The principle of separation is based on differences in the hydrodynamic radius of the molecules in solution.

Molecules with a larger radius elute earlier and those with the smallest radius are retained longer.

The separation limit is such that only those compounds which differ by more than 10% in MW can be separated by SEC.

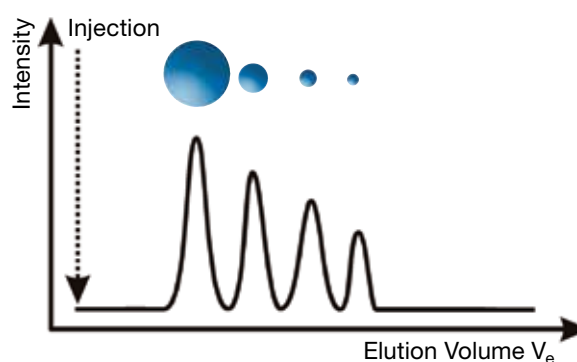
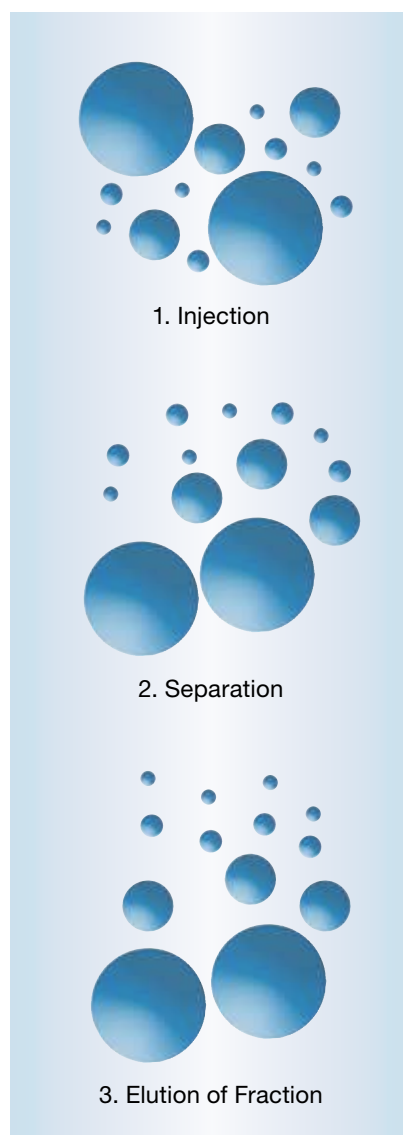

small molecules = long retention time
bigger molecules = short retention time

Large molecules exit the column more rapidly as they cannot permeate the porous structure of stationary phase. Smaller ones with the lowest hydrodynamic volume elute with longer retention times because they are able to penetrate some or all of the pores of the stationary phase. Molecules of intermediate size elute in an intermediate position.

YMC-Pack Diol

SEC Applications for YMC-Pack Diol*

For separation of proteins with molecular weights from 10,000 to several 100,000

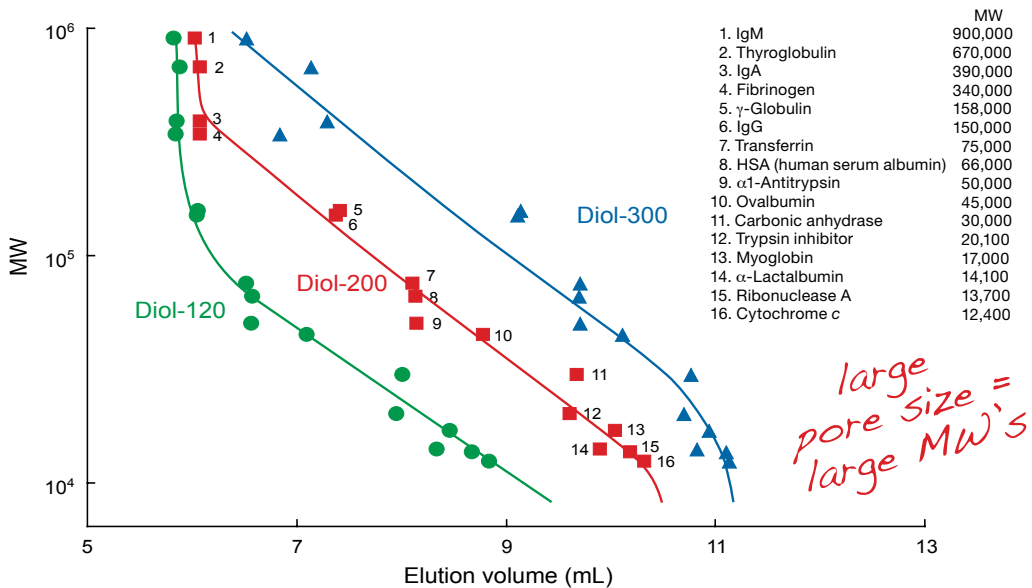

Column: YMC-Pack Diol, 300 x 8.0 mm ID
 Eluent: 0.1 M KH_2PO_4 - K_2HPO_4 (pH 7.0) containing 0.2 M NaCl
 Flow rate: 0.5 mL/min
 Temperature: 25 °C
 Detection: UV at 280 nm

For separation of proteins with molecular weights below 10,000

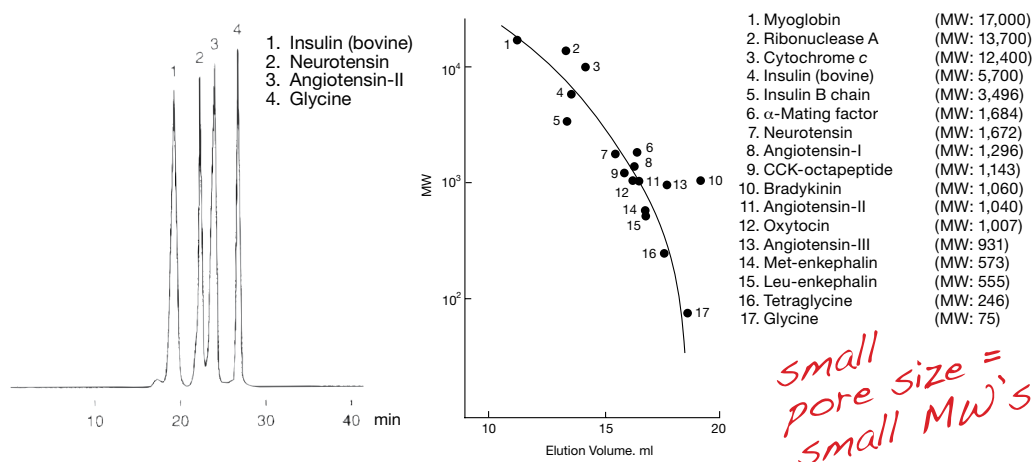

Column: YMC-Pack Diol (6 nm) 500 x 8.0 mm ID
 Part No.: DL06S05-5008WT
 Eluent: 0.1 M KH_2PO_4 - K_2HPO_4 (pH 7) containing 0.2 M NaCl / acetonitrile (70/30)
 Flow rate: 0.7 mL/min
 Temperature: ambient
 Detection: UV at 215 nm

YMC-Pack Diol

SEC Applications for YMC-Pack Diol*

For molecular weight determination of oligosaccharides and polysaccharides

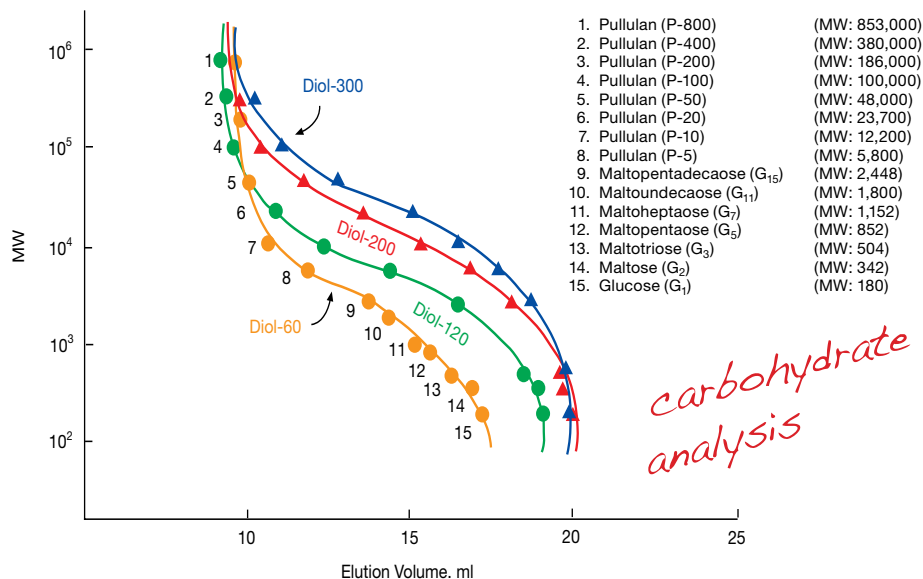
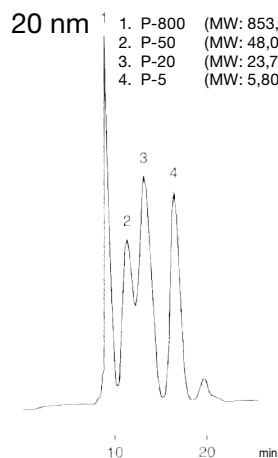

Column: YMC-Pack Diol (20 nm) 500 x 8.0 mm ID
 Eluent: water
 Flow rate: 1.0 mL/min
 Temperature: ambient
 Detection: RI

Column Selection Tool

YMC-Pack Diol-60	for MW < 10.000
YMC-Pack Diol-120	for MW 5.000 to 100.000
YMC-Pack Diol-200	for MW 10.000 to several 100.000
YMC-Pack Diol-300	for MW several 10.000 to 1.000.000

YMC-Pack Diol

High flexibility

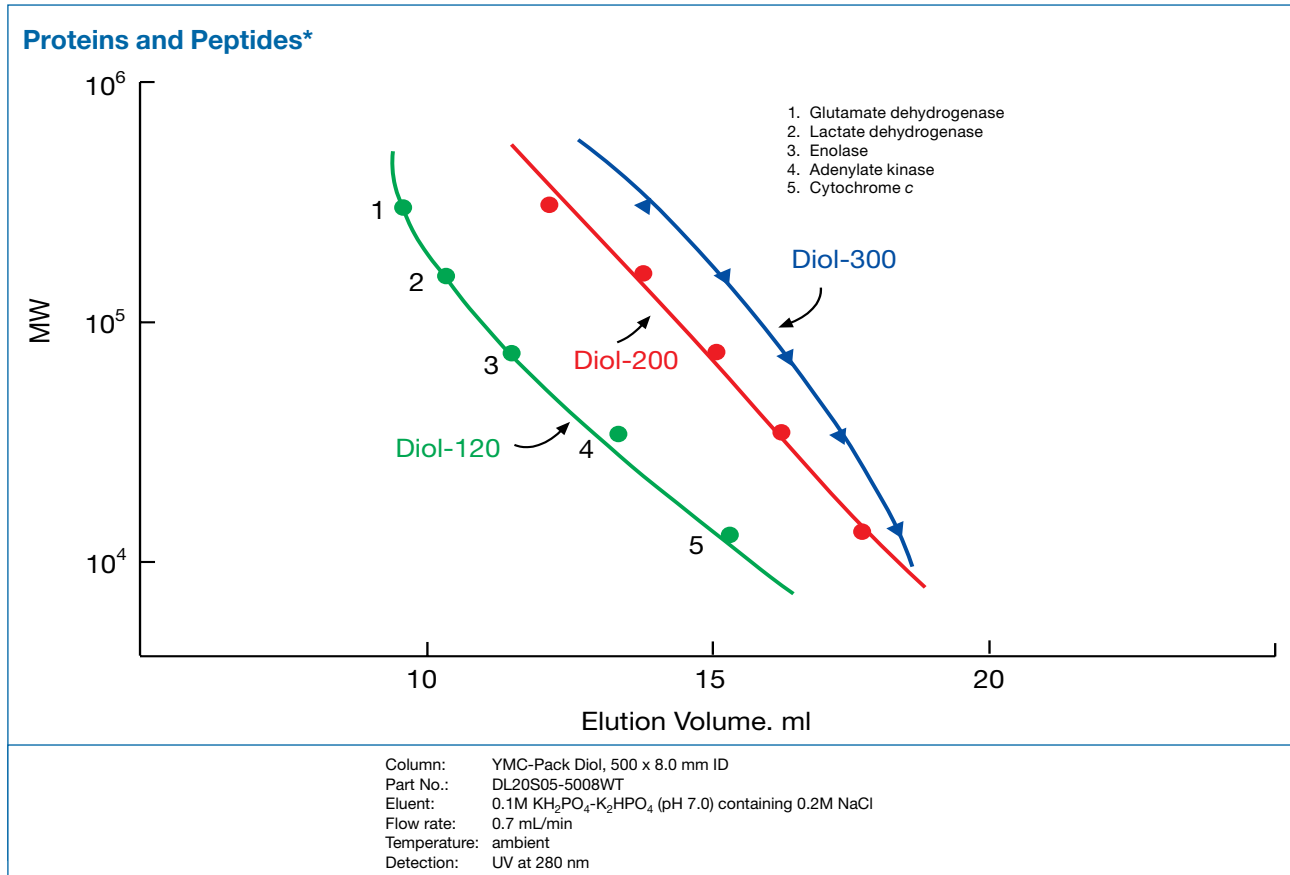

Scalability

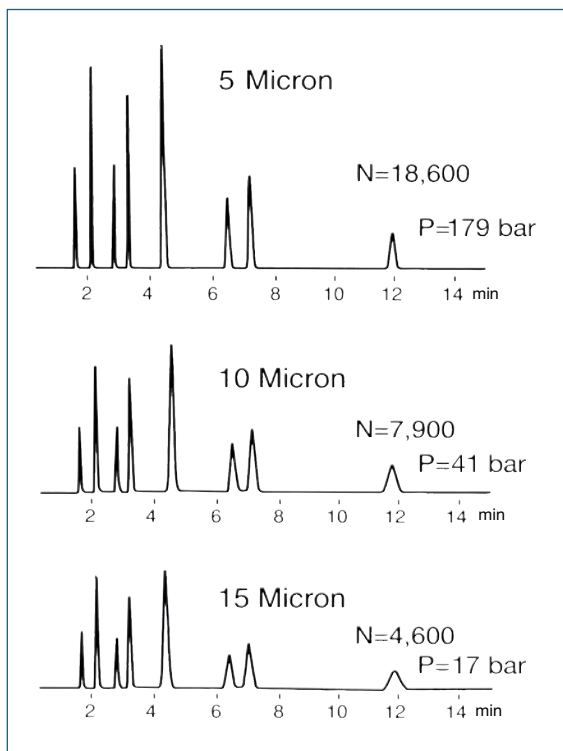

YMC guarantees a seamless, reproducible scale up through all particle sizes for all stationary phases

For further information about Diol bulk media please refer to page 312-317.

YMC-Pack Diol

Reproducibility

YMC-Pack Diol columns have the reputation, not only for their high versatility and excellent cost/performance ratio, but also for their high degree of lot-to-lot reproducibility.

YMC-Pack Diol-120*

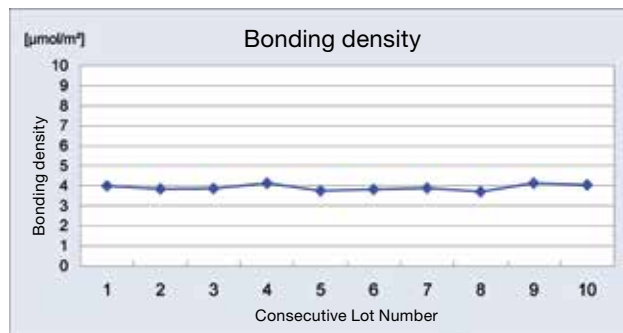
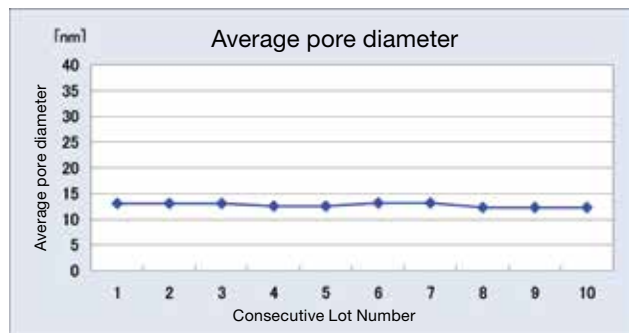

YMC-Pack Diol-200*

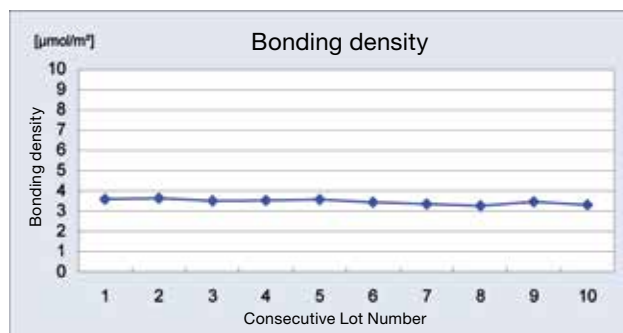
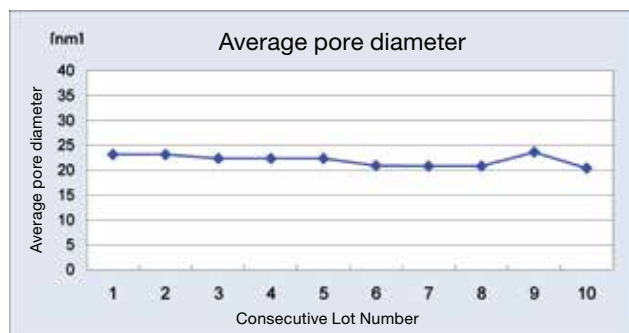

YMC-Pack Diol-300*

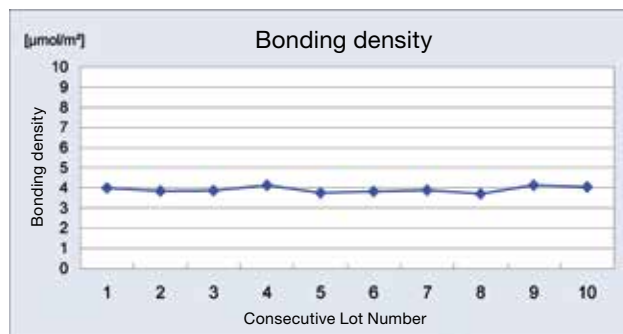
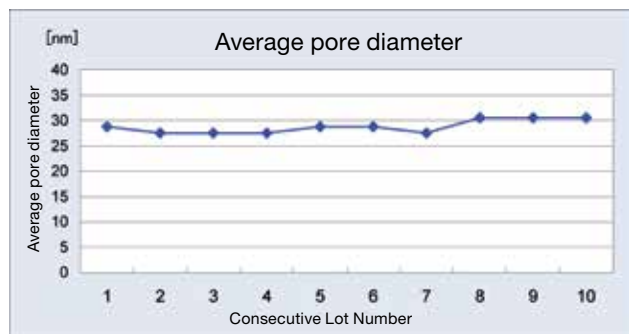

YMC-Pack Diol

SEC Applications for YMC-Pack Diol*

Plasmid pBR322 restriction fragment

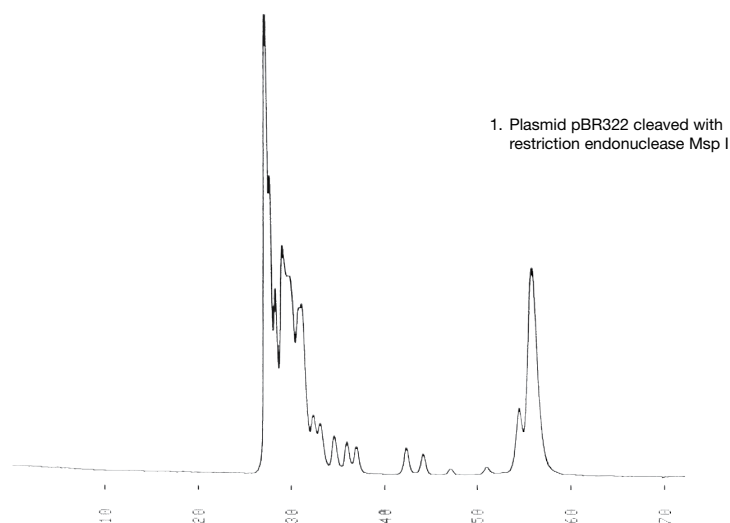

Column: YMC-Pack Diol-300 + Diol-200, 500 x 8.0 mm ID x 2
 Part No.: DL30S05-5008WT + DL20S05-5008WT
 Eluent: 0.1M KH₂PO₄-K₂HPO₄ (pH 7.0) containing 0.2M NaCl
 Flow rate: 0.7 mL/min
 Temperature: ambient (26 °C)
 Detection: UV at 260 nm, 0.01 AUFS
 Injection: 3 µL (0.49 mg/mL)
 Sample: Plasmid pBR322 cleaved with restriction endonuclease Msp I

Plasmid pBR322 restriction and pBR322 Hae III restriction fragment

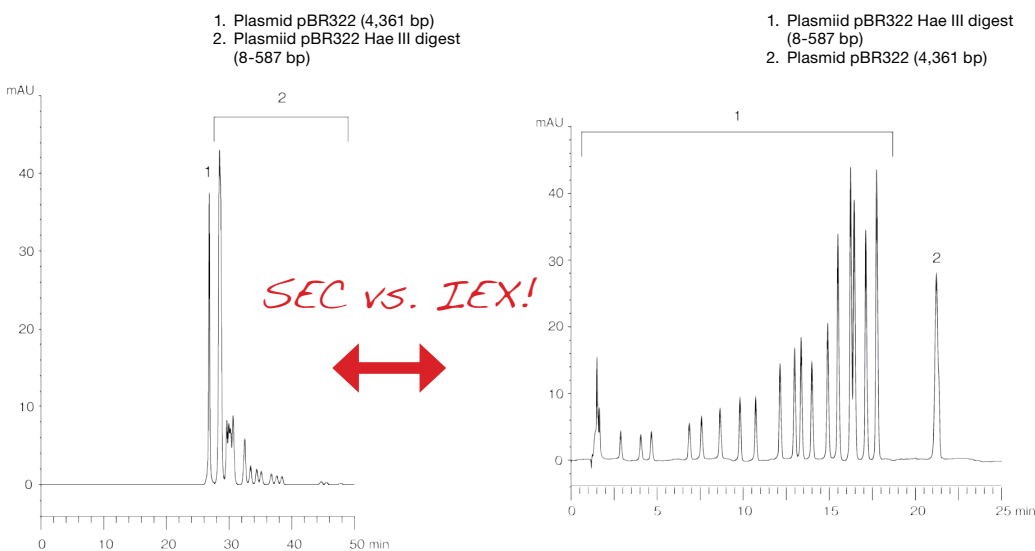

Column: YMC-Pack Diol-300 + Diol-200, 500 x 8.0 mm ID x 2
 Part No.: DL30S05-5008WT
 DL20S05-5008WT
 Eluent: 0.1 M KH₂PO₄-K₂HPO₄ (pH 7.0) containing 0.2 M NaCl
 Flow rate: 0.7 mL/min
 Temperature: ambient (25 °C)
 Detection: UV at 260 nm
 Injection: 10 µL

Column: YMC-BioPro QA-F (5 µm), 100 x 4.6 mm ID
 Part No.: QF00S05-1046WP
 Eluent: A) 20 mM Tris-HCl (pH 8.1)
 B) 20 mM Tris-HCl (pH 8.1) containing 0.1 M NaCl
 Gradient: 70-85% B (0-20 min), 85% B (20-25 min)
 Flow rate: 0.5 mL/min
 Temperature: 35 °C
 Detection: UV at 260 nm
 Injection: 10 µL

YMC-Pack Diol

SEC Applications for YMC-Pack Diol*

Peptide fragments from myoglobin

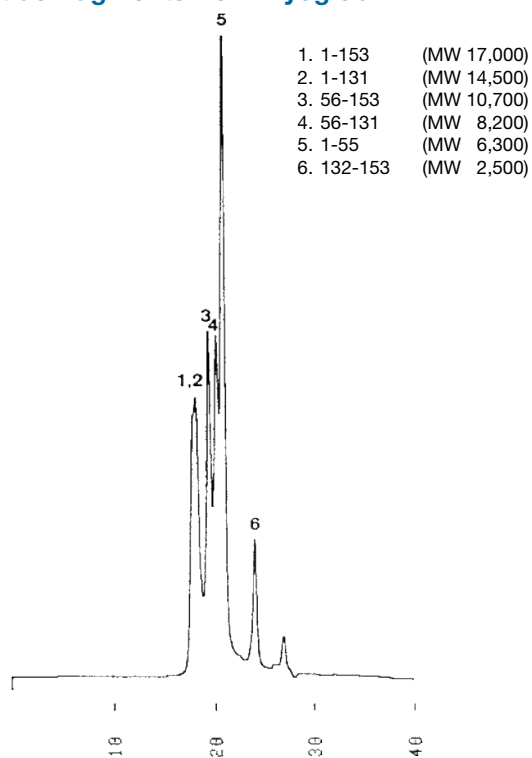

Column: YMC-Pack Diol-120, 500 x 8.0 mm ID
 Part No.: DL12S05-5008WT
 Eluent: 0.1 M KH_2PO_4 - K_2HPO_4 (pH 7.0) containing 0.2 M NaCl/acetonitrile (70/30)
 Flow rate: 0.7 mL/min
 Temperature: ambient (25 °C)
 Detection: UV at 215 nm, 0.32 AUFS
 Injection: 20 μL (2.0 mg/mL)
 Sample: Cyanogen bromide cleavages of horse heart myoglobin. Molecular Weight Marker for proteins, manufactured by Fluka Chemie AG.

Proteins in human serum

YMC-Pack Diol-300 + Diol-200
 300 x 8.0 mm ID x 2

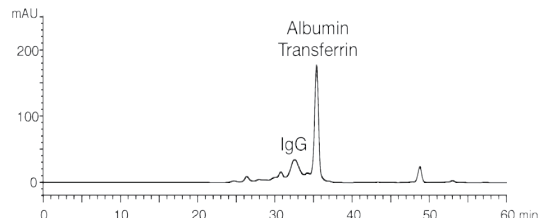

YMC-Pack Diol-300
 300 x 8.0 mm ID

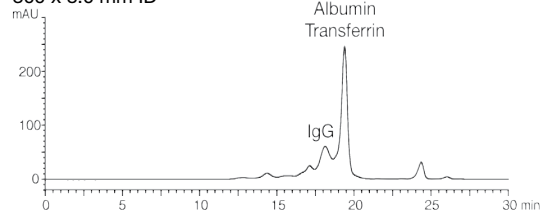

YMC-Pack Diol-200
 300 x 8.0 mm ID

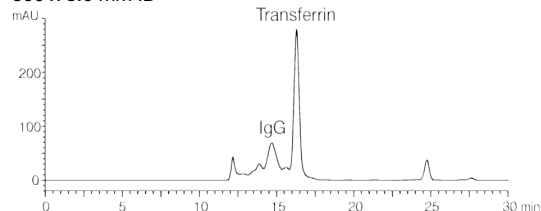

Eluent: 0.1 M KH_2PO_4 - K_2HPO_4 (pH 7.0) containing 0.2 M NaCl
 Flow rate: 0.5 mL/min
 Temperature: ambient (25 °C)
 Detection: UV at 280 nm
 Injection: 20 μL
 Sample: Human serum (100 $\mu\text{L}/\text{mL}$)

Peptide mapping

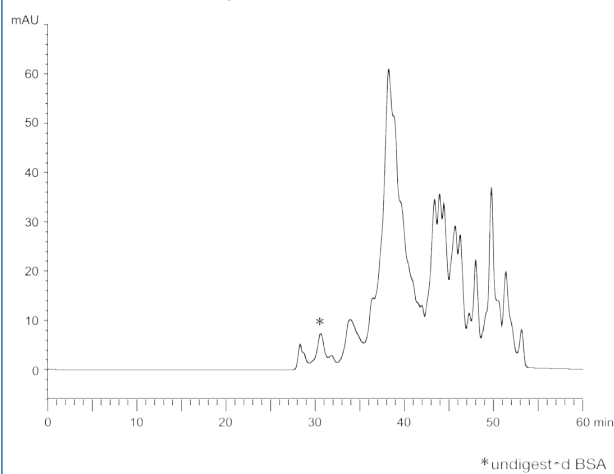

Column: YMC-Pack Diol-120 + Diol-60, 500 x 8.0 mm ID x 2
 Part No.: DL12S05-5008WT + DL06S05-5008WT
 Eluent: 0.1 M KH_2PO_4 - K_2HPO_4 (pH 7.0) containing 0.2 M NaCl/acetonitrile (70/30)
 Flow rate: 0.7 mL/min
 Temperature: ambient (25 °C)
 Detection: UV at 220 nm
 Injection: 5 μL
 Sample: Tryptic digest of BSA

Proteins in mouse ascites fluid

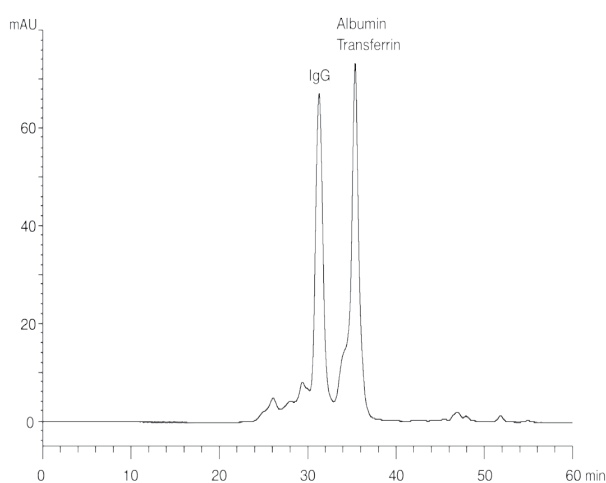

Column: YMC-Pack Diol-300 + Diol-200, 300 x 4.6 mm ID x 2
 Part No.: DL30S05-3046WT + DL20S05-3046WT
 Eluent: 0.1 M KH_2PO_4 - K_2HPO_4 (pH 7.0)
 Flow rate: 0.17 mL/min
 Temperature: ambient (25 °C)
 Detection: UV at 220 nm
 Injection: 10 μL (60 times dilution with water)

YMC-Pack Diol

SEC Applications for YMC-Pack Diol*

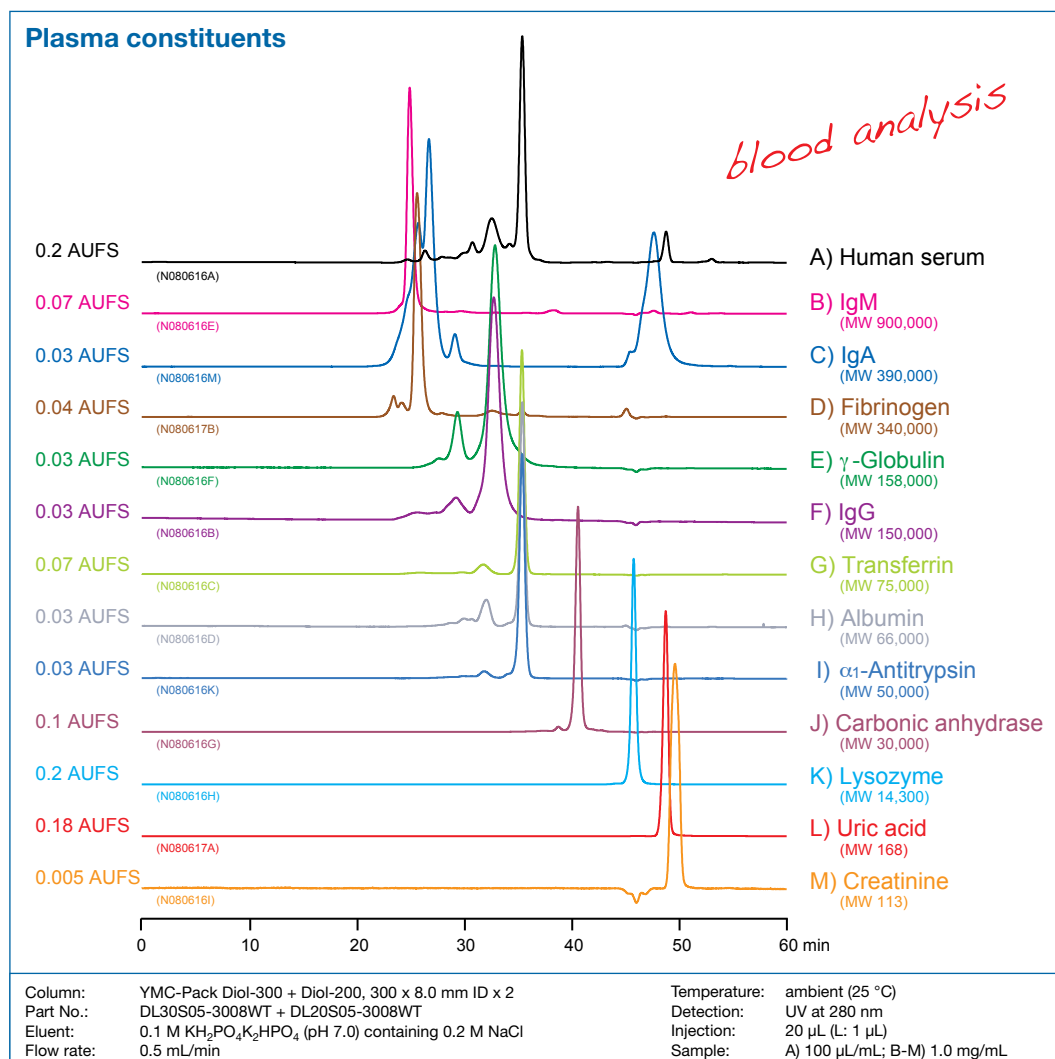

YMC-Pack Diol

SEC Applications for YMC-Pack Diol*

IgG, Fab and Fc fragments

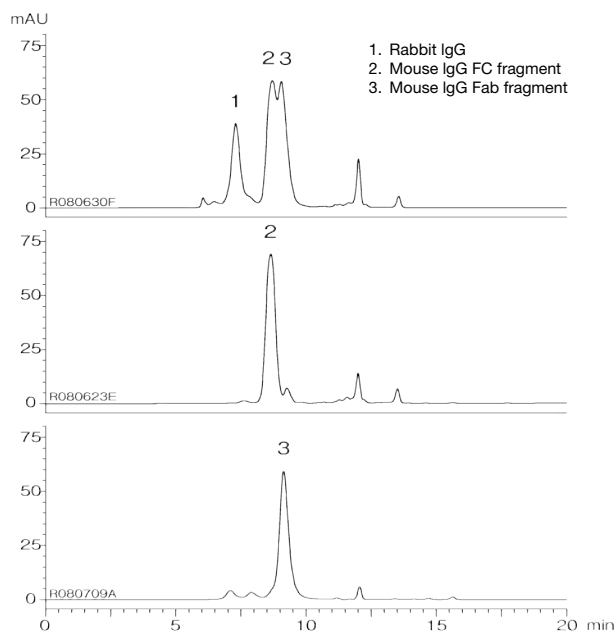

Column: YMC-Pack Diol-200, 300 x 8.0 mm ID
Part No.: DL20S05-3008WT
Eluent: 0.1 M KH_2PO_4 - K_2HPO_4 (pH 6.9) containing 0.2 M NaCl
Flow rate: 1.0 mL/min
Temperature: ambient (27 °C)
Detection: UV at 220 nm
Injection: 5 μL (0.4, 0.5 mg/mL)

Human Immunglobulin

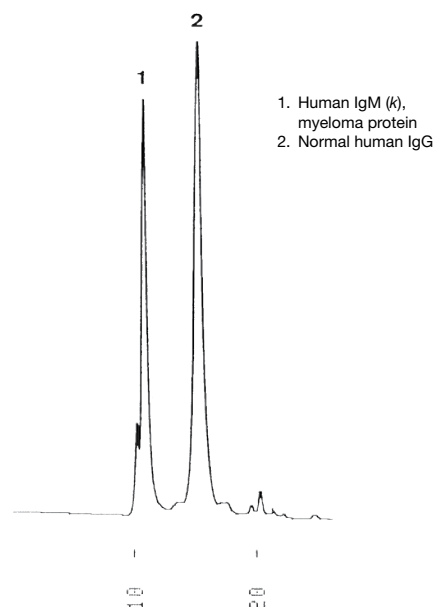

Column: YMC-Pack Diol-300, 500 x 8.0 mm ID
Part No.: DL30S05-5008WT
Eluent: 0.1M NaH_2PO_4 - Na_2HPO_4 (pH6.8) containing 0.1M Na_2SO_4
Flow rate: 1.0 mL/min
Temperature: ambient (24 °C)
Detection: UV at 280 nm, 0.04 AUFS
Injection: 40 μL (0.5 mg/mL)

Human IgG (λ), myeloma protein

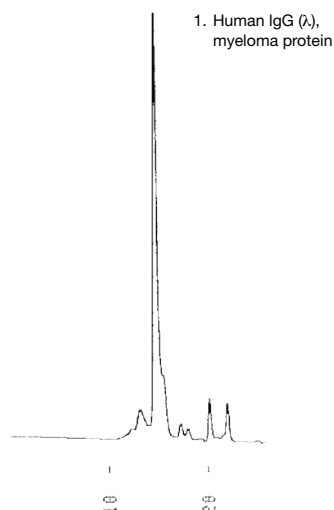

Column: YMC-Pack Diol-300 + Diol-200, 500 x 8.0 mm ID x 2
Part No.: DL30S05-5008WT + DL20S05-5008WT
Eluent: 0.1 M KH_2PO_4 - K_2HPO_4 (pH 7.0) containing 0.2 M NaCl
Flow rate: 0.7 mL/min
Temperature: ambient (25 °C)
Detection: UV at 260 nm
Injection: 10 μL

Monoclonal antibody (MAb)

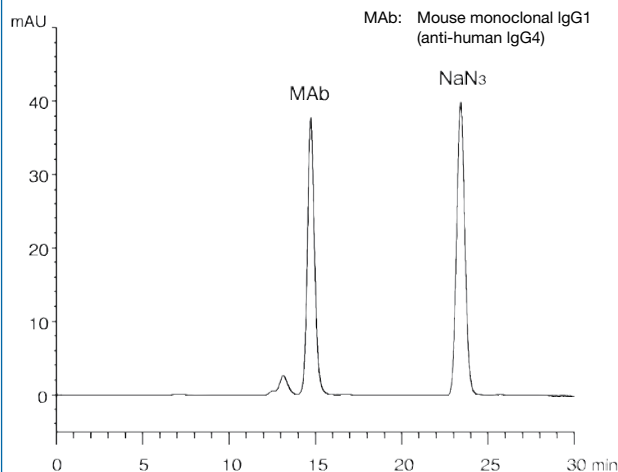

Column: YMC-Pack Diol-200, 300 x 4.6 mm ID
Part No.: DL20S05-3046WT
Eluent: 0.1 M KH_2PO_4 - K_2HPO_4 (pH 7.0)
Flow rate: 0.17 mL/min
Temperature: ambient (25 °C)
Detection: UV at 220 nm
Injection: 10 μL
Sample: a commercially available mouse monoclonal IgG1 (0.05 mg/mL) (purified by DEAE chromatography, containing NaN_3)

YMC-Pack Diol

SEC Applications for YMC-Pack Diol*

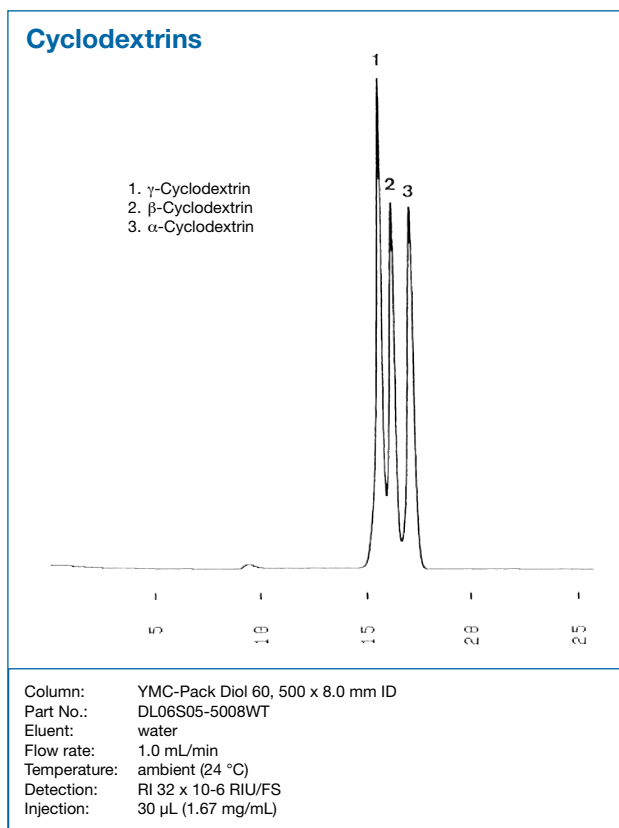
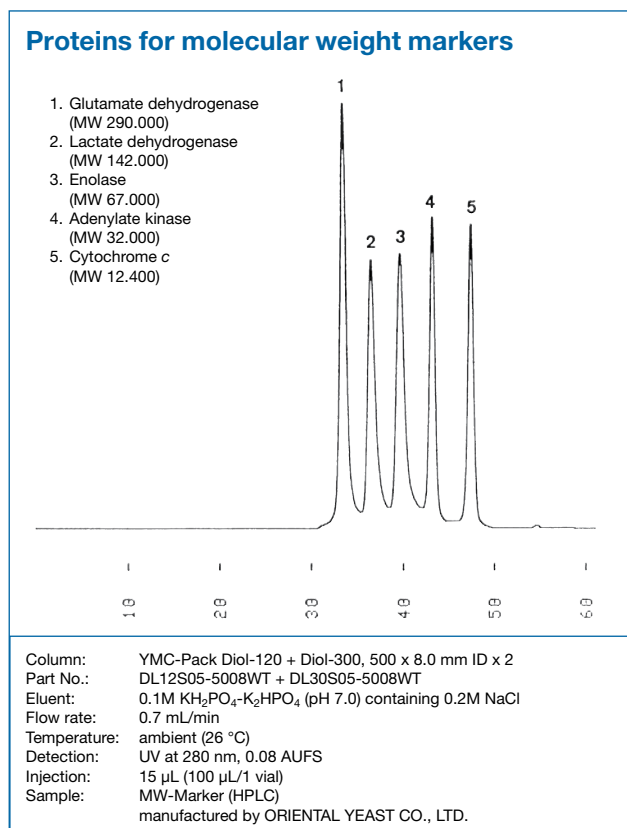
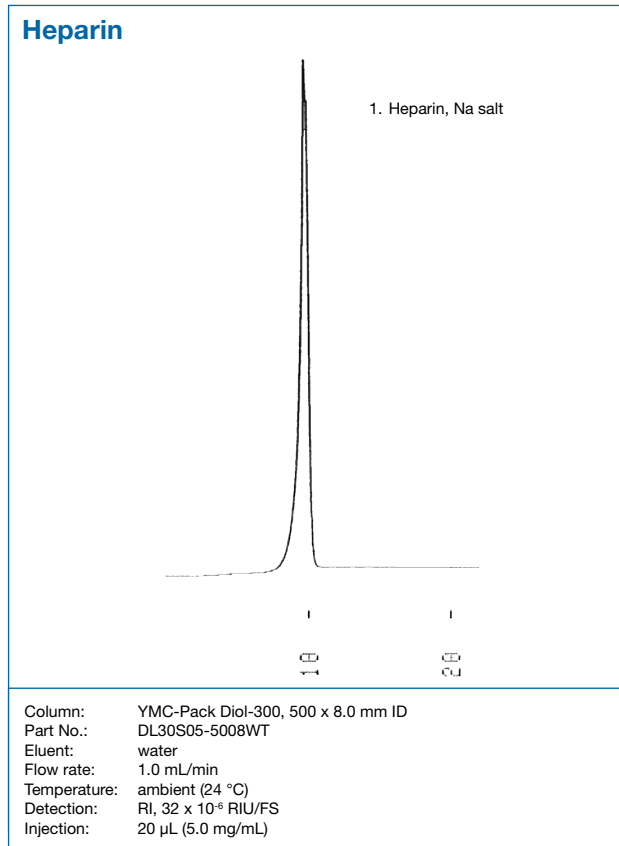
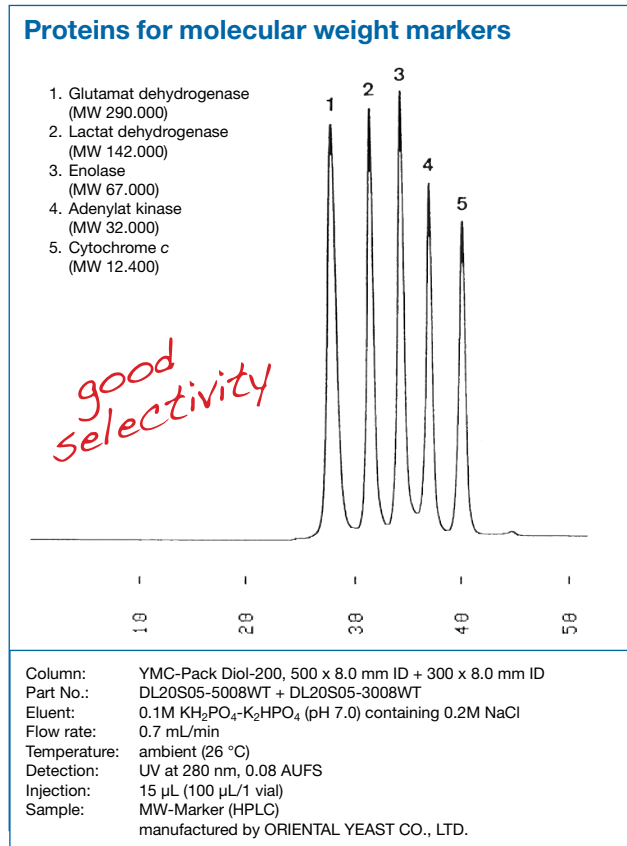

YMC-Pack Diol

SEC Applications for YMC-Pack Diol*

Glycine oligomers

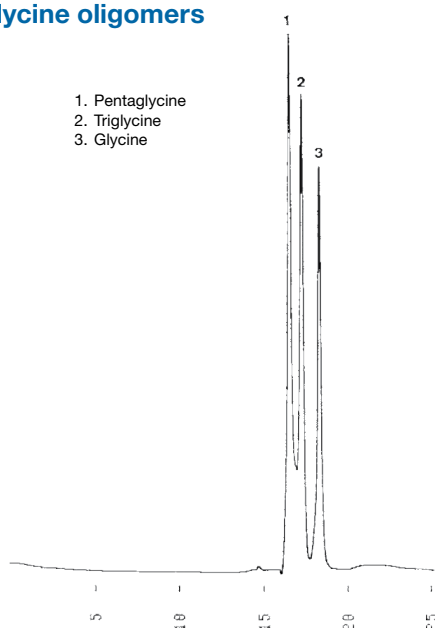

Column: YMC-Pack Diol-60, 500 x 8.0 mm ID
Part No.: DL06S05-5008WT
Eluent: 0.1M KH_2PO_4 - K_2HPO_4 (pH 7.0) / acetonitrile (70/30)
Flow rate: 1.0 mL/min
Temperature: ambient (24 °C)
Detection: UV at 215 nm, 0.08 AUFS
Injection: 20 μL (0.25 ~ 2.5 mg/mL)

Peptides

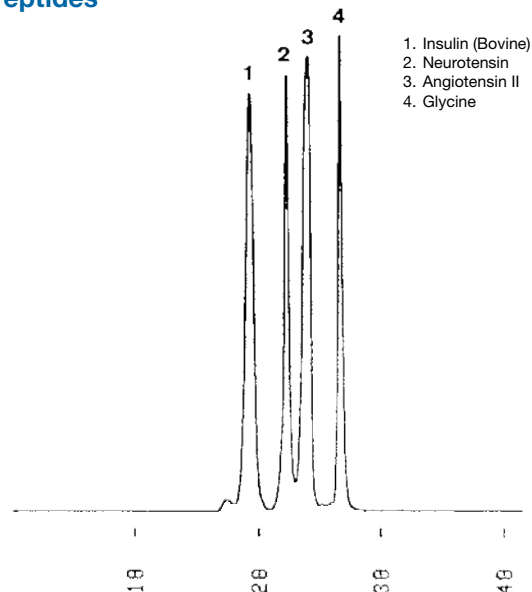

Column: YMC-Pack Diol-60, 500 x 8.0 mm ID
Part No.: DL06S05-5008WT
Eluent: 0.1M KH_2PO_4 - K_2HPO_4 (pH 7.0) / containing 0.2 M NaCl / acetonitrile (70/30)
Flow rate: 0.7 mL/min
Temperature: ambient (25 °C)
Detection: UV at 215 nm, 0.16 AUFS
Injection: 25 μL (0.07 ~ 5.3 mg/mL)

Peptides

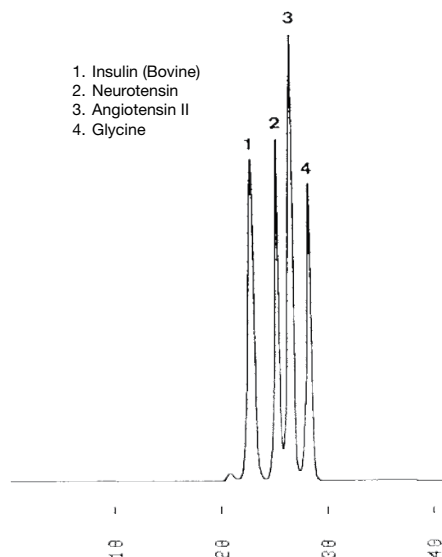

Column: YMC-Pack Diol-120, 500 x 8.0 mm ID
Part No.: DL12S05-5008WT
Eluent: 0.1M KH_2PO_4 - K_2HPO_4 (pH 7.0) / containing 0.2 M NaCl / acetonitrile (70/30)
Flow rate: 0.7 mL/min
Temperature: ambient (25 °C)
Detection: UV at 215 nm, 0.16 AUFS
Injection: 25 μL (0.07 ~ 5.3 mg/mL)

Peptides

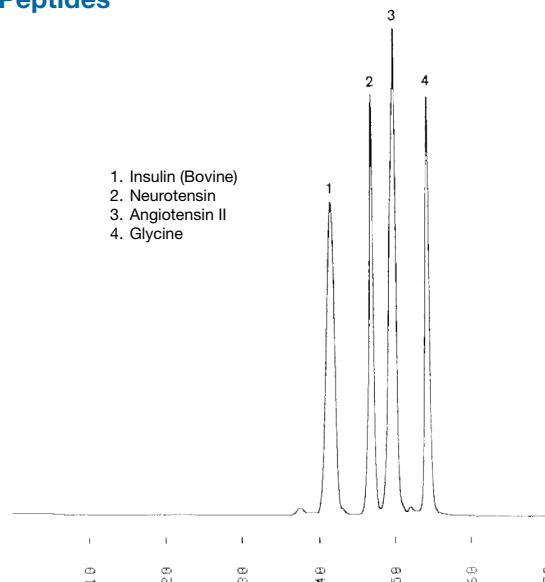

Column: YMC-Pack Diol-120 + 60, 500 x 8.0 mm ID x 2
Part No.: DL12S05-5008WT + DL06S05-5008WT
Eluent: 0.1M KH_2PO_4 - K_2HPO_4 (pH 7.0) / containing 0.2 M NaCl / acetonitrile (70/30)
Flow rate: 0.7 mL/min
Temperature: ambient (25 °C)
Detection: UV at 215 nm, 0.16 AUFS
Injection: 25 μL (0.07 ~ 5.3 mg/mL)

YMC-Pack Diol

SEC Applications for YMC-Pack Diol*

Proteins for molecular weight markers

1. Glutamate dehydrogenase (MW 290,000)
2. Lactate dehydrogenase (MW 142,000)
3. Enolase (MW 67,000)
4. Adenylate kinase (MW 32,000)
5. Cytochrome c (MW 12,400)

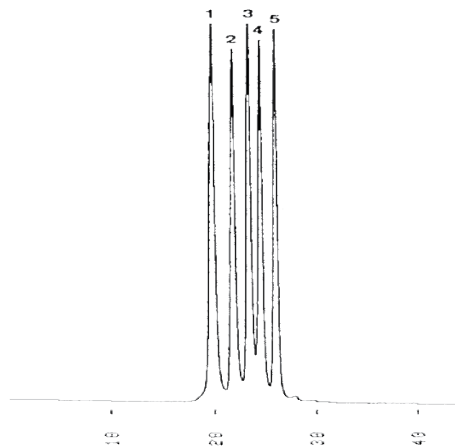

Column: YMC-Pack Diol-300, 500 x 8.0 mm ID
 Part No.: DL30S05-5008WT
 Eluent: 0.1 M KH_2PO_4 - K_2HPO_4 (pH 7.0) containing 0.2 M NaCl
 Flow rate: 0.7 mL/min
 Temperature: ambient (26 °C)
 Detection: UV at 280 nm, 0.08 AUFS
 Injection: 15 μL (100 μL / 1 vial)
 Sample: MW-Marker (HPLC), manufactured by ORIENTAL YEAST CO., LTD.

Proteins for molecular weight markers

1. Glutamate dehydrogenase (MW 290,000)
2. Lactate dehydrogenase (MW 142,000)
3. Enolase (MW 67,000)
4. Adenylate kinase (MW 32,000)
5. Cytochrome c (MW 12,400)

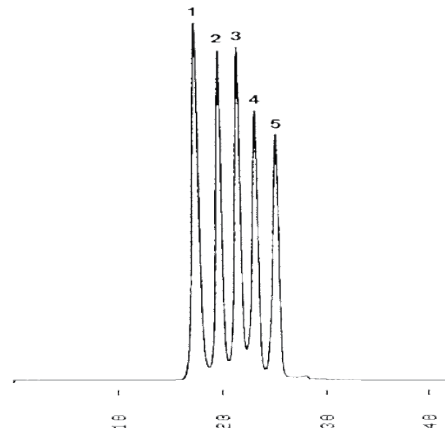

Column: YMC-Pack Diol-200, 500 x 8.0 mm ID
 Part No.: DL20S05-5008WT
 Eluent: 0.1 M KH_2PO_4 - K_2HPO_4 (pH 7.0) containing 0.2 M NaCl
 Flow rate: 0.7 mL/min
 Temperature: ambient (26 °C)
 Detection: UV at 280 nm, 0.08 AUFS
 Injection: 15 μL (100 μL / 1 vial)
 Sample: MW-Marker (HPLC), manufactured by ORIENTAL YEAST CO., LTD.

Proteins for molecular weight markers

1. Glutamate dehydrogenase (MW 290,000)
2. Lactate dehydrogenase (MW 142,000)
3. Enolase (MW 67,000)
4. Adenylate kinase (MW 32,000)
5. Cytochrome c (MW 12,400)

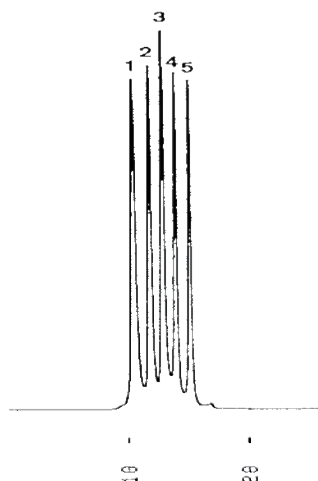

Column: YMC-Pack Diol-200, 300 x 8.0 mm ID
 Part No.: DL20S05-3008WT
 Eluent: 0.1 M KH_2PO_4 - K_2HPO_4 (pH 7.0) containing 0.2 M NaCl
 Flow rate: 0.7 mL/min
 Temperature: ambient (26 °C)
 Detection: UV at 280 nm, 0.08 AUFS
 Injection: 15 μL (100 μL / 1 vial)
 Sample: MW-Marker (HPLC), manufactured by ORIENTAL YEAST CO., LTD.

Proteins for molecular weight markers

1. Glutamate dehydrogenase (MW 290,000)
2. Lactate dehydrogenase (MW 142,000)
3. Enolase (MW 67,000)
4. Adenylate kinase (MW 32,000)
5. Cytochrome c (MW 12,400)

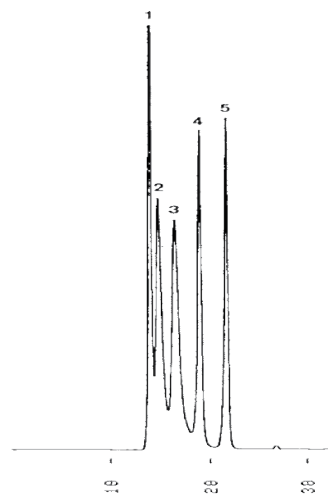

Column: YMC-Pack Diol-120, 500 x 8.0 mm ID
 Part No.: DL12S05-5008WT
 Eluent: 0.1 M KH_2PO_4 - K_2HPO_4 (pH 7.0) containing 0.2 M NaCl
 Flow rate: 0.7 mL/min
 Temperature: ambient (26 °C)
 Detection: UV at 280 nm, 0.08 AUFS
 Injection: 15 μL (100 μL / 1 vial)
 Sample: MW-Marker (HPLC), manufactured by ORIENTAL YEAST CO., LTD.

Ordering Information

YMC-Pack Diol, 3 µm

Phase dimension	Column ID [mm]	Column length [mm]	
		250	300
6 nm 3 µm	4.6	DL06S03-2546WT	DL06S03-3046WT
	6.0	n.a.	DL06S03-3006WT
	8.0	n.a.	DL06S03-3008WT
12 nm 3 µm	4.6	DL12S03-2546WT	DL12S03-3046WT
	6.0	n.a.	DL12S03-3006WT
	8.0	n.a.	DL12S03-3008WT
20 nm 3 µm	4.6	DL20S03-2546WT	DL20S03-3046WT
	6.0	n.a.	DL20S03-3006WT
	8.0	n.a.	DL20S03-3008WT
30 nm 3 µm	4.6	DL30S03-2546WT	DL30S03-3046WT
	6.0	n.a.	DL30S03-3006WT
	8.0	n.a.	DL30S03-3008WT

YMC-Pack Diol, 5 µm

Phase dimension	Column ID [mm]	Column length [mm]		
		250	300	500
6 nm 5 µm	4.6	DL06S05-2546WT	DL06S05-3046WT	n.a.
	6.0	DL06S05-2506WT	DL06S05-3006WT	DL06S05-5006WT
	8.0	n.a.	DL06S05-3008WT	DL06S05-5008WT
	10.0	DL06S05-2510WT	DL06S05-3010WT	DL06S05-5010WT
12 nm 5 µm	4.6	DL12S05-2546WT	DL12S05-3046WT	n.a.
	6.0	DL12S05-2506WT	DL12S05-3006WT	DL12S05-5006WT
	8.0	n.a.	DL12S05-3008WT	DL12S05-5008WT
	10.0	DL12S05-2510WT	DL12S05-3010WT	DL12S05-5010WT
20 nm 5 µm	4.6	DL20S05-2546WT	DL20S05-3046WT	n.a.
	6.0	DL20S05-2506WT	DL20S05-3006WT	DL20S05-5006WT
	8.0	n.a.	DL20S05-3008WT	DL20S05-5008WT
	10.0	DL20S05-2510WT	DL20S05-3010WT	DL20S05-5010WT
30 nm 5 µm	4.6	DL30S05-2546WT	DL30S05-3046WT	n.a.
	6.0	DL30S05-2506WT	DL30S05-3006WT	DL30S05-5006WT
	8.0	n.a.	DL30S05-3008WT	DL30S05-5008WT
	10.0	DL30S05-2510WT	DL30S05-3010WT	DL30S05-5010WT

Guard Columns are available for the different column dimensions.
For more details please contact us: Phone 02064-427-0 or email info@ymc.de.

Bulk media

Phase	Pore Size	Particle Size	Part No.
YMC*Gel Diol-HG	12	10 µm	DLG12S11
		15 µm	DLG12S16
		20 µm	DLG12S21
YMC*Gel Diol-HG	20	10 µm	DLG20S11
		15 µm	DLG20S16
		20 µm	DLG20S21
YMC*Gel Diol-HG	30	10 µm	DLG30S11
		15 µm	DLG30S16
		20 µm	DLG30S21

Pack Sizes: 100 g; 500 g; 1 kg; 5 kg; 10 kg; 25 kg

NOTE: customised particle sizes and pore sizes are available on request.
Contact YMC Europe GmbH for details and ordering information.

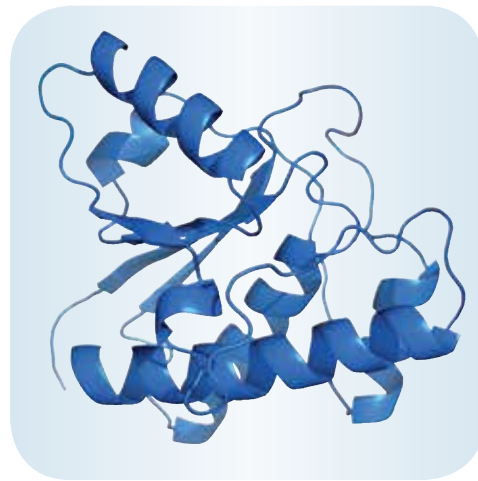
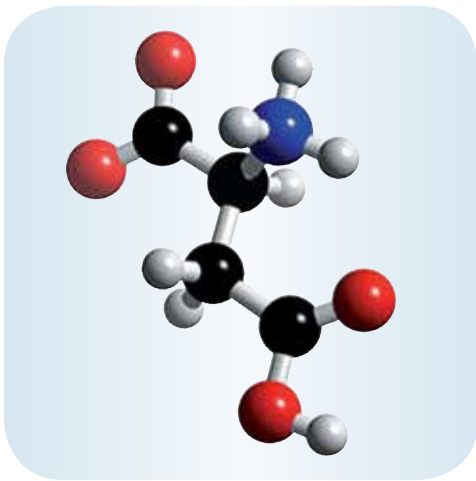

RP

Bioseparation Columns

- YMC-Pack ODS-A: C18 with wide pore size for separation of peptides and proteins
- YMC-Pack ODS-AQ: "hydrophilic" C18
- C8 with wide pore size for separation of relatively highly hydrophobic compounds
- C4 with wide pore size for different selectivity from C18



C18-Selectivities for peptides	YMC-Triart C18	YMC-Pack Pro C18	YMC-Pack ODS-A
Particle size / μm	1.9; 3; 5	2; 3; 5	3; 5
Pore size / nm	12	12	12; 20; 30
Carbon content / %	20	16	17; 12; 7
pH range	1.0 - 12.0	2.0 - 8.0	2.0 - 7.5

C18-Selectivities for peptides	YMC-Pack ODS-AQ	Hydrosphere C18	Meteoric Core C18 BIO
Particle size / μm	3; 5	2; 3; 5	2.7
Pore size / nm	12; 20	12	16
Carbon content / %	14; 10	12	5
pH range	2.0 - 7.5	2.0 - 8.0	1.5 - 10.0

C8-Selectivities for peptides and proteins	YMC-Triart C8	YMC-Pack C ₈	YMCbasic
Particle size / μm	1.9; 3; 5	3; 5	3; 5
Pore size / nm	12	12; 20; 30	20
Carbon content / %	20	10; 7; 4	7
pH range	1.0 - 12.0	2.0 - 7.5	2.0 - 7.5

C4-Selectivities or equivalent for peptides and proteins	YMC-Pack C ₄	YMC-Pack PROTEIN-RP
Particle size / μm	3; 5	5
Pore size / nm	12; 20; 30	20
Carbon content / %	7; 5; 3	4
pH range	2.0 - 7.5	1.5 - 7.5

Bioseparation Columns

Chromatographers know the problems during method development: “Which phase is suitable and allows a simple and robust separation?”

In the field of biochromatography, phase selection is a key to success!

With the YMC's "Column Selection Tool" for Bio-LC, stationary phase selection is almost too easy.

As shown in the table (below), the C18 column with 12 nm pore size is suitable for small peptides up to a MW 5000. The best efficiency for large peptides or small proteins can be obtained by employing a C8 phase characterised by a 20 nm pore size. Furthermore, most proteins are eluted effectively by a C4 column with 30 nm.

However, the separation may also be influenced by the hydrophobicity of the peptide/protein and the nature of the column's bonded phase. Therefore, for initial method development, it might be useful, in the first instance, to follow the arrow shown in the table for method optimisation.

Comparison of peaks on C4 with 12 nm and 30 nm pore sizes*

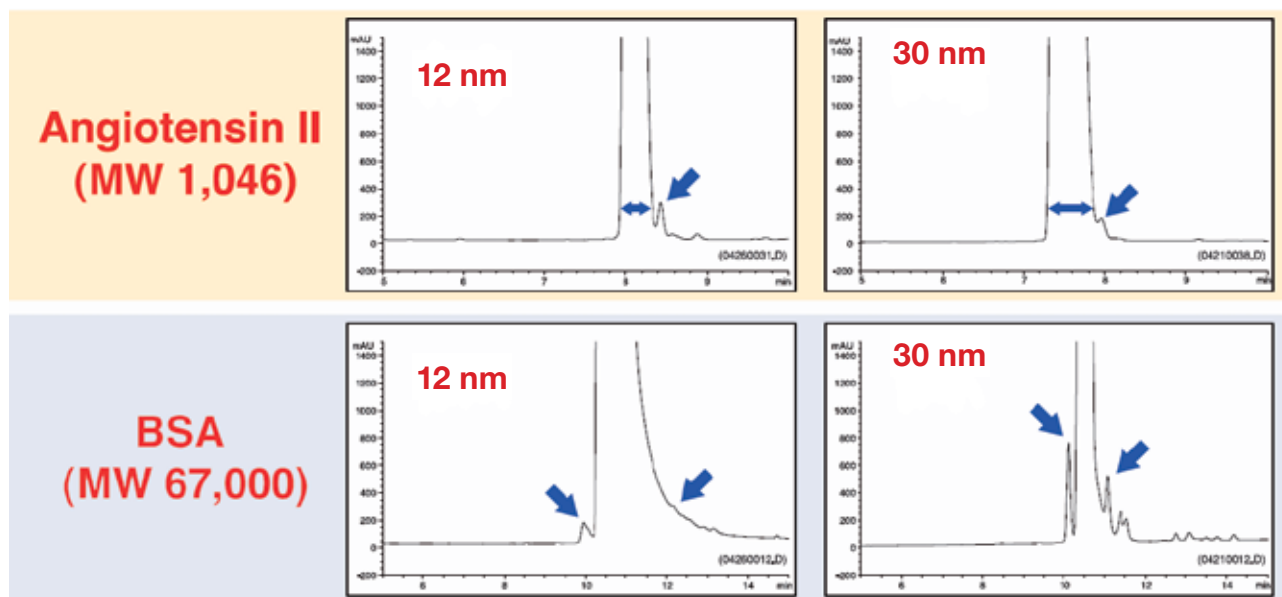

For smaller peptides a small pore size is more successful. Larger molecules are separated much better with larger pore sizes!

Column Selection Tool*

MW		C18	C8	C4
 5000 20000 100000	12 nm	⊙	○	△
	20 nm	○	⊙	○
	30 nm	△	○	⊙

⊙ : excellent, ○ : good, △ : moderate

Bioseparation Columns

Peptide and Protein Applications*

Peptides and Proteins

- | | |
|---------------------------------------|-----------|
| 1. Cytochrome c (Horse heart) | MW 12,400 |
| 2. Insulin (Bovine pancreas) | MW 5,733 |
| 3. Amyloid β -protein (1-40) | MW 4,330 |
| 4. Lysozyme (Chicken egg white) | MW 14,300 |
| 5. α -Lactalbumin (Human milk) | MW 14,100 |
| 6. Myoglobin (Horse skeletal muscle) | MW 17,000 |

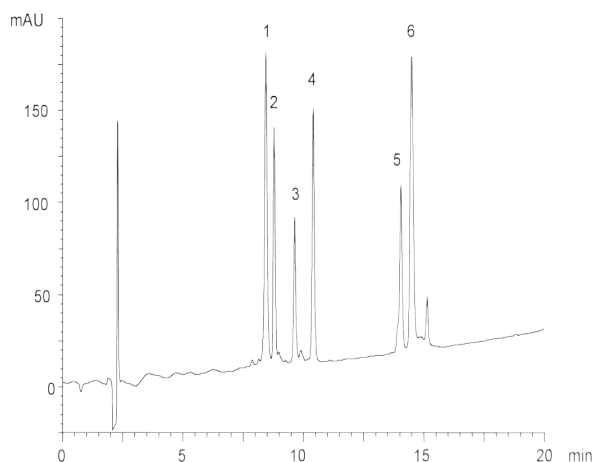

Column: YMC-Pack C8 (5 μ m, 20 nm) 150 x 4.6 mm ID
 Part No.: OC20S05-1546WT
 Eluent: A) water / TFA (100/0.1)
 B) acetonitrile / TFA (100/0.1)
 Gradient: 25-60% B (0-20 min)
 Flow rate: 1.0 mL/min
 Temperature: 37 °C
 Detection: UV at 220 nm
 Injection: 10 μ L (0.1 ~ 0.2 mg/mL)

Proteins

- | | |
|-----------------------------------|-----------|
| 1. BSA | MW 66,000 |
| 2. Conalbumin (Chicken egg white) | MW 77,000 |
| 3. Lipoxidase (Soybean) | MW 96,000 |

* Impurities in commercial lipoxidase

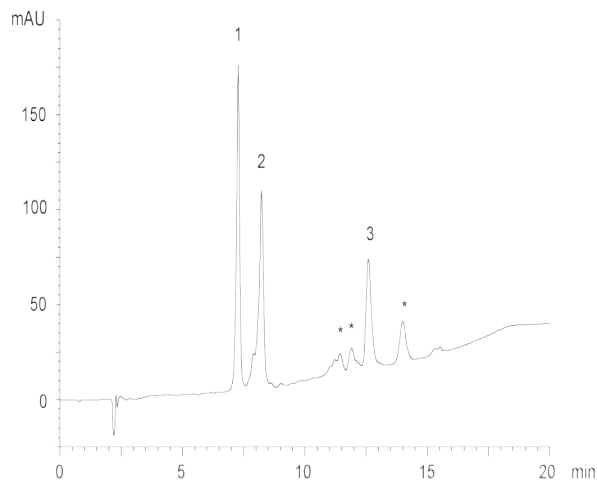

Column: YMC-Pack C4 (5 μ m, 30 nm) 150 x 4.6 mm ID
 Part No.: BU30S05-1546WT
 Eluent: A) water / TFA (100/0.1)
 B) acetonitrile / 2-propanol / TFA (50/50/0.1)
 Gradient: 30-75% B (0-15 min), 75% B (15-20 min)
 Flow rate: 1.0 mL/min
 Temperature: 37 °C
 Detection: UV at 220 nm
 Injection: 10 μ L (0.25 ~ 1.0 mg/mL)

Proteins

- | | |
|---|-----------|
| 1. β -Lactoglobulin B (Bovine milk) | MW 18,300 |
| 2. β -Lactoglobulin A (Bovine milk) | MW 18,400 |
| 3. α -Chymotrypsinogen A (Bovine pancreas) | MW 18,300 |
| 4. Ovalbumin | MW 45,000 |

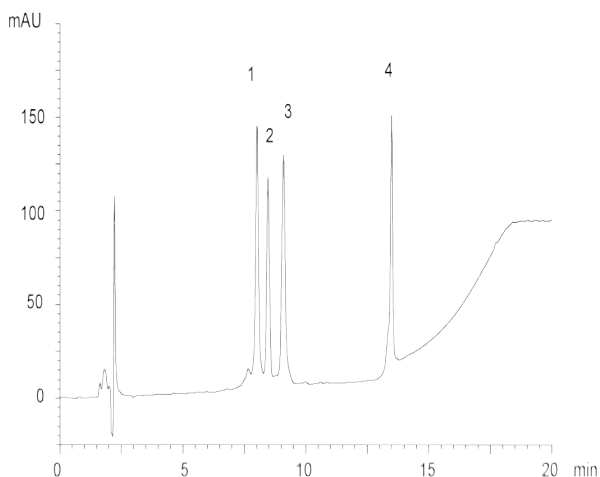

Column: YMC-Pack C4 (5 μ m, 30 nm) 150 x 4.6 mm ID
 Part No.: BU30S05-1546WT
 Eluent: A) water / TFA (100/0.1)
 B) acetonitrile / TFA (100/0.1)
 Gradient: 40-50% B (0-10 min), 50-90% B (10-15 min), 90% B (15-20 min)
 Flow rate: 1.0 mL/min
 Temperature: 37 °C
 Detection: UV at 220 nm
 Injection: 10 μ L (0.2 ~ 0.3 mg/mL)

Proteins

- | |
|-------------------|
| 1. Ribonuclease A |
| 2. Cytochrome c |
| 3. Lysozyme |
| 4. Myoglobin |



Column: YMC-Pack C4 (5 μ m, 30 nm) 150 x 4.6 mm ID
 Part No.: BU30S05-1546WT
 Eluent: A) acetonitrile / water / TFA (5/95/0.1)
 B) acetonitrile / water / TFA (60/40/0.1)
 Gradient: 30%-90% B (0-20 min., linear), 90% B (20-50 min)
 Flow rate: 1.0 mL/min
 Temperature: 37 °C
 Detection: UV at 220 nm

Bioseparation Columns

Peptide and Protein Applications*

Peptide mapping - excellent reproducibility between 5 μ m and 2 μ m

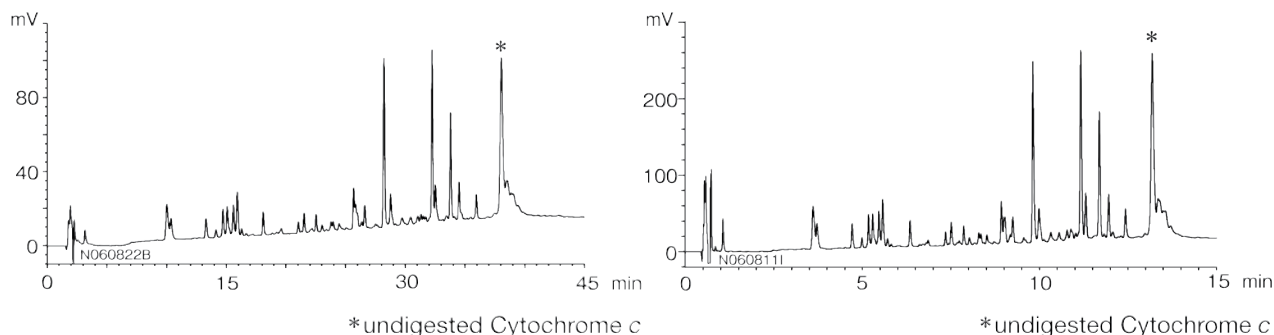

Column: YMC-Pack Pro C18 (5 μ m, 12 nm) 150 \times 2.0 mm ID
 Part No.: AS12S05-1502WT
 Eluent: A) acetonitrile/water/trifluoroacetic acid (10/90/0.1)
 B) acetonitrile/water/trifluoroacetic acid (35/65/0.1)
 Gradient:

Time	A (in %)	B (in %)
0	100	0
5	100	0
40	0	100
45	0	100

 Flow rate: 0.2 mL/min
 Temperature: 37 $^{\circ}$ C
 Detection: UV at 220 nm
 Injection: 1 μ L
 Sample: Tryptic digest of Cytochrome c

Column: YMC-UltraHT Pro C18 (2 μ m, 12 nm) 50 \times 2.0 mm ID
 Part No.: AS12S02-0502WT
 Eluent: A) acetonitrile/water/trifluoroacetic acid (10/90/0.1)
 B) acetonitrile/water/trifluoroacetic acid (35/65/0.1)
 Gradient:

Time	A (in %)	B (in %)
0	100	0
1.65	100	0
13.35	0	100
15.00	0	100

 Flow rate: 0.2 mL/min
 Temperature: 37 $^{\circ}$ C
 Detection: UV at 220 nm
 Injection: 1 μ L
 Sample: Tryptic digest of Cytochrome c

Peptides and proteins

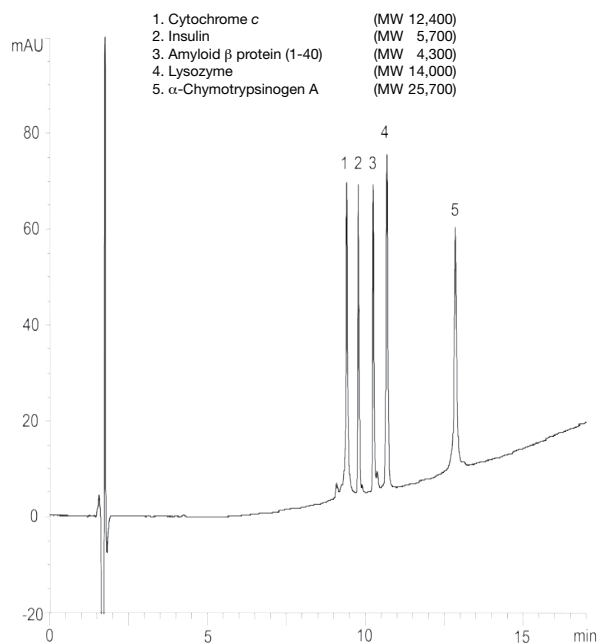

Column: Meteoric Core C18 BIO (2.7 μ m, 16 nm) 150 \times 2.1 mm ID
 Part No.: CAW08SQ7-15Q1PT
 Eluent: A) water/TFA (100/0.1)
 B) acetonitrile/TFA (100/0.1)
 20-70% B (0-15 min), 70% B (15-17 min)
 Flow rate: 0.2 mL/min
 Temperature: 40 $^{\circ}$ C
 Detection: UV at 220 nm
 Injection: 2 μ L (0.05-0.2 mg/mL)
 Pressure: 12.8-16.1 MPa (1860-2330 psi)

Peptides

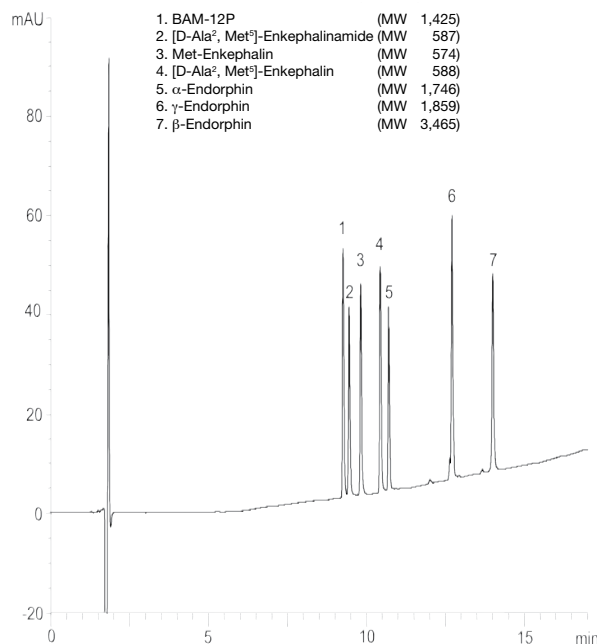

Column: Meteoric Core C18 BIO (2.7 μ m, 16 nm) 150 \times 2.1 mm ID
 Part No.: CAW08SQ7-15Q1PT
 Eluent: A) water/TFA (100/0.1)
 B) acetonitrile/TFA (100/0.1)
 15-55% B (0-15 min), 55% B (15-17 min)
 Flow rate: 0.2 mL/min
 Temperature: 40 $^{\circ}$ C
 Detection: UV at 220 nm
 Injection: 2 μ L (0.02-0.5 mg/mL)
 Pressure: 14.9-16.1 MPa (2160-2330 psi)

Bioseparation Columns

Peptide and Protein Applications*

Peptide mapping

mAU Lysyl endopeptidase digest of BSA (5 mg/mL; 37°C, 24 h)

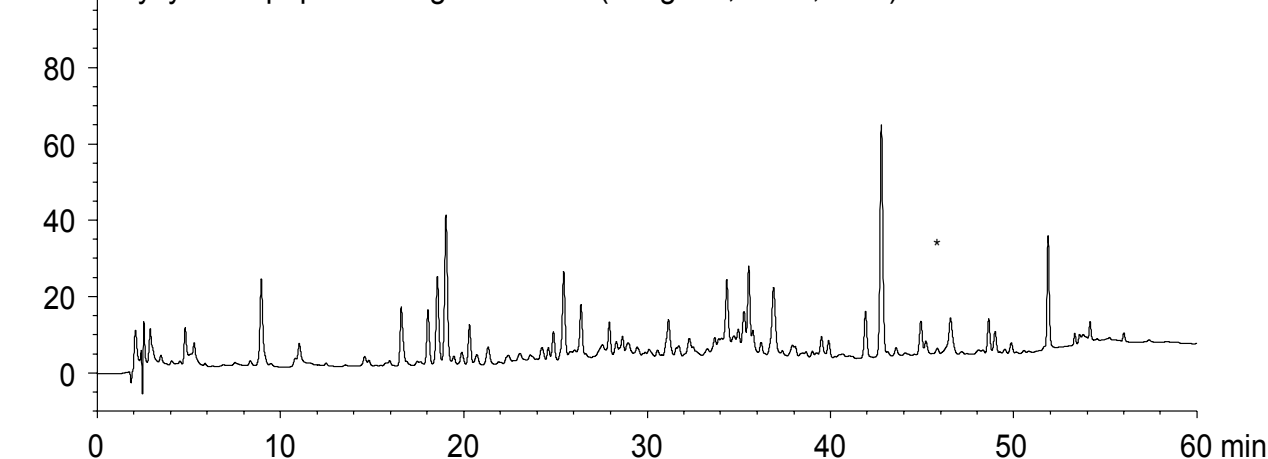

Column: YMCbasic (5 μ m) 150 x 2.0 mm ID
 Part No.: BA99S05-1502WT
 Eluent: A) water / TFA (94/6) B) acetonitrile / TFA (100/0.1)
 Gradient: 5-35% B (0-50 min), 35-45% B (50-55 min), 45% B (55-60 min)
 Flow rate: 0.2 mL/min
 Temperature: 37 °C
 Detection: UV at 220 nm
 Injection: 1 μ L

* undigested BSA

Improved stability when used with TFA solution

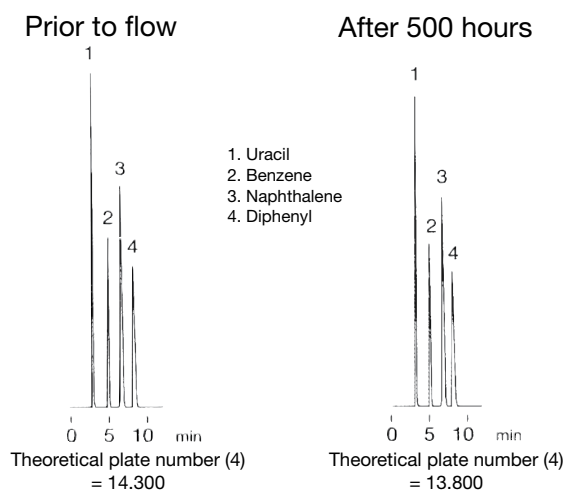
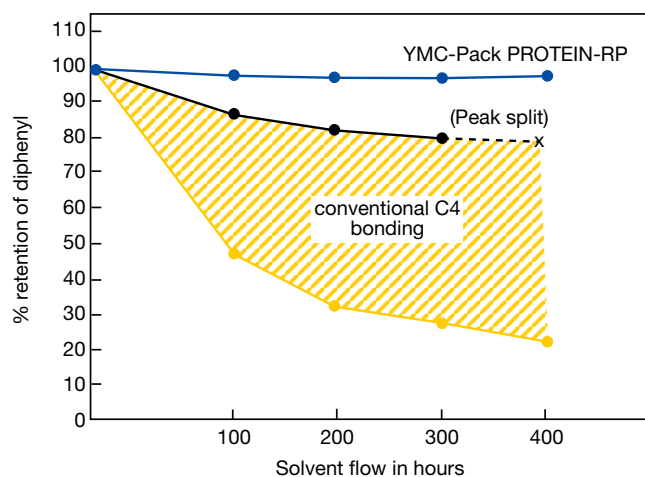

Flow conditions
 Eluent: water / TFA (100/0.1)
 Flow rate: 1.0 mL/min
 Temperature: ambient

Measurement conditions
 Column: YMC-Pack PROTEIN-RP (5 μ m) 250 x 4.6 mm ID
 Part No.: PR99S05-2546WT
 Eluent: acetonitrile / water (40/60)
 Flow rate: 1.0 mL/min
 Temperature: 30° C
 Detection: UV at 254 nm, 0.32 AUFS

The selectivity of YMC-Pack PROTEIN-RP is different from that seen with conventional wide pore butyl phases and it is specifically suited for the protein analysis.

In the applications below it effectively separates both low molecular weight compounds and high molecular weight proteins, with equally good peak shapes being obtained.

Bioseparation Columns

Peptide and Protein Applications*

Antimicrobial peptides

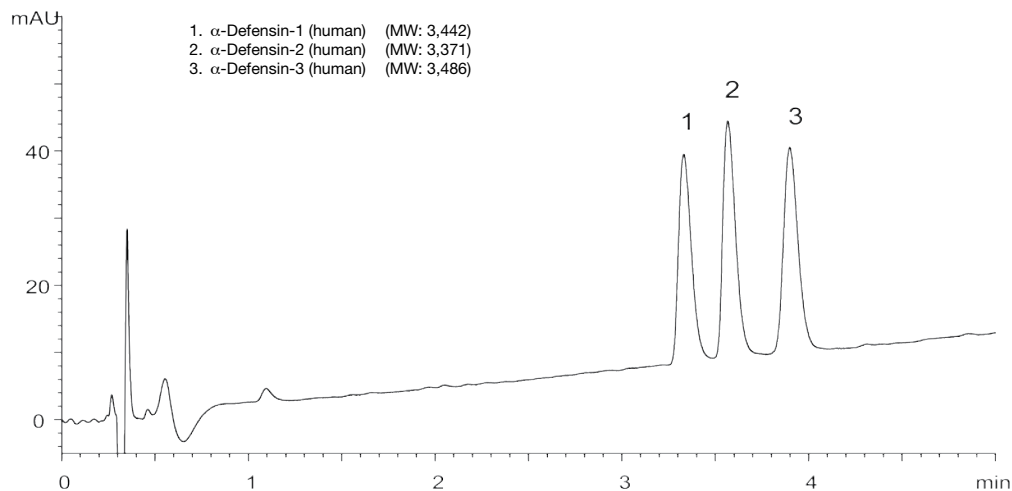

Column: YMC-Triart C18 (1.9 μ m, 12 nm) 50 x 2.0 mm ID
 Part No.: TA12SP9-0502PT
 Eluent: A) water / formic acid (100/0.1)
 B) 2-propanol / acetonitrile / formic acid (50/50/0.08)
 Gradient: 10%-25% B (0-10 min)
 Flow rate: 0.4 mL/min
 Temperature: 70 °C
 Detection: UV at 220 nm
 Injection: 1 μ L (50 μ g/mL)

Peptides

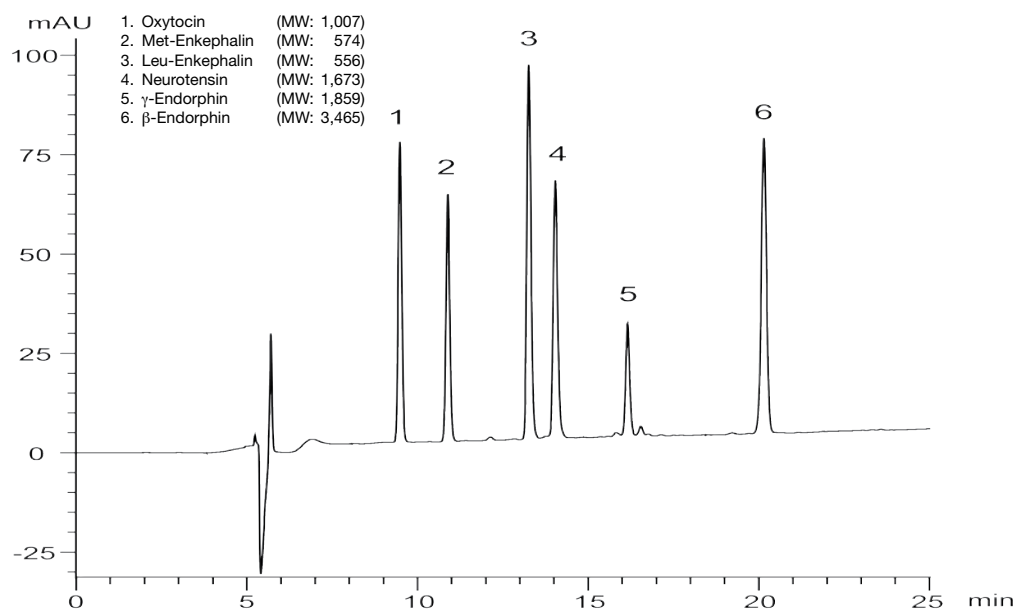

Column: YMC-Triart C18 (5 μ m, 12 nm) 150 x 2.0 mm ID
 Part No.: TA12S05-1502WT
 Eluent: A) water / TFA (100/0.1)
 B) acetonitrile / TFA (100/0.1)
 Gradient: 20%-45% B (0-25 min)
 Flow rate: 0.2 mL/min
 Temperature: 37 °C
 Detection: UV at 220 nm
 Injection: 2 μ L (0.075 \approx 0.25 mg/mL)

Bioseparation Columns

Peptide and Protein Applications*

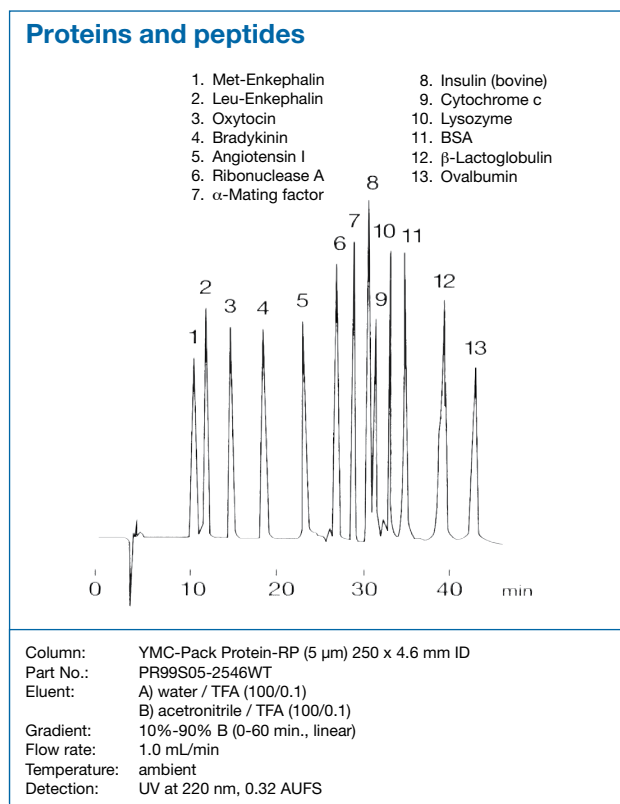
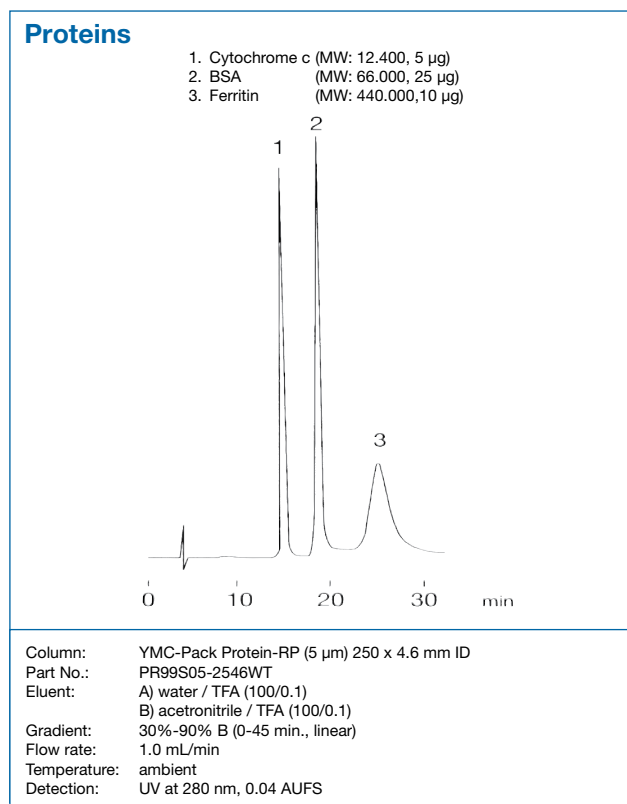

Oligonucleotide Applications*

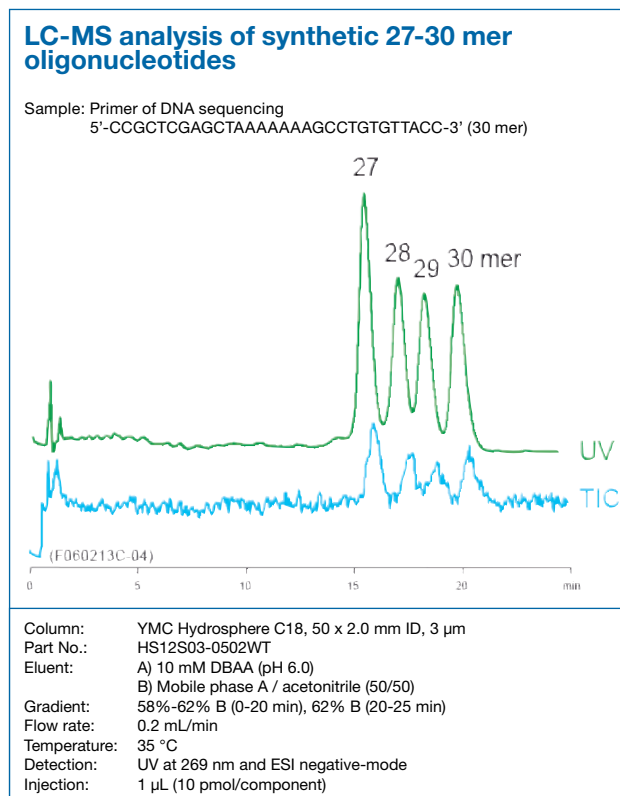
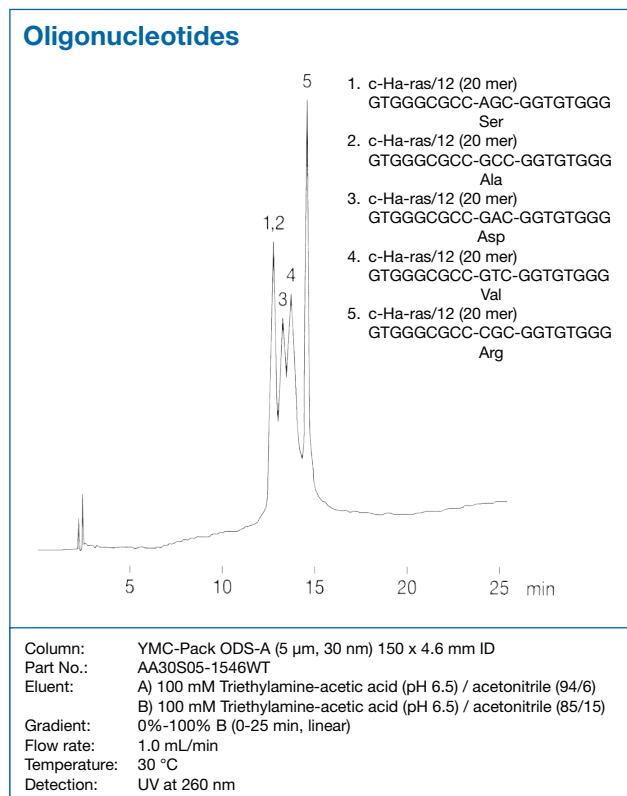

Bioseparation Columns

Outstanding separation of highly polar compounds*

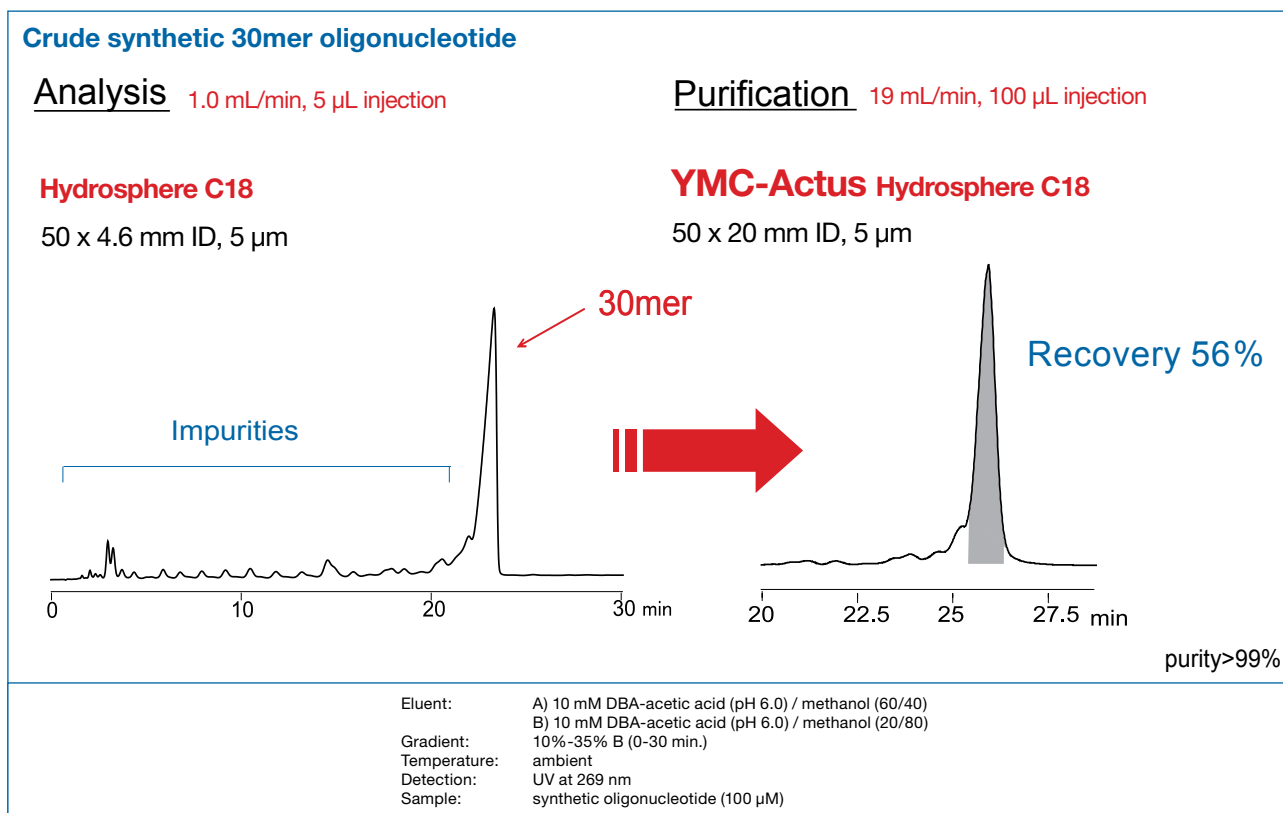

Ordering Information

12 nm, 1.9 μ m analytical columns

Phase	Column ID [mm]	Column length [mm]			
		30	50	100	150
YMC-Triart C18	2.0	TA12SP9-0302PT	TA12SP9-0502PT	TA12SP9-1002PT	TA12SP9-1502PT
	3.0	—	TA12SP9-0503PT	TA12SP9-1003PT	TA12SP9-1503PT
YMC-Triart C8	2.0	TO12SP9-0302PT	TO12SP9-0502PT	TO12SP9-1002PT	TO12SP9-1502PT
	3.0	—	TO12SP9-0503PT	TO12SP9-1003PT	TO12SP9-1503PT

12 nm, 2 μ m analytical columns

Phase	Column ID [mm]	Column length [mm]			
		30	50	100	150
YMC-UltraHT Pro C18	2.0	AS12S02-0302WT	AS12S02-0502WT	AS12S02-1002WT	AS12S02-1502WT
	3.0	AS12S02-0303WT	AS12S02-0503WT	AS12S02-1003WT	AS12S02-1503WT
YMC-UltraHT Hydrosphere C18	2.0	HS12S02-0302WT	HS12S02-0502WT	HS12S02-1002WT	HS12S02-1502WT
	3.0	HS12S02-0303WT	HS12S02-0503WT	HS12S02-1003WT	HS12S02-1503WT

12/16 nm, 2.7/3 μ m analytical columns, C18

Phase	Column ID [mm]	Column length [mm]	
		150	250
YMC-Triart C18	2.1	TA12S03-15Q1PTH	—
	3.0	TA12S03-1503PTH	—
	4.6	TA12S03-1546PTH	TA12S03-2546PTH
YMC-Triart C8	2.1	TO12S03-15Q1PTH	—
	3.0	TO12S03-1503PTH	—
	4.6	TO12S03-1546PTH	TO12S03-2546PTH
YMC-Pack ODS-A (C18)	2.1	AA12S03-15Q1QT	AA12S03-25Q1QT
	3.0	AA12S03-1503QT	AA12S03-2503QT
	4.6	AA12S03-1546WT	AA12S03-2546WT
YMC-Pack ODS-AQ (C18)	2.1	AQ12S03-15Q1QT	AQ12S03-25Q1QT
	3.0	AQ12S03-1503QT	AQ12S03-2503QT
	4.6	AQ12S03-1546WT	AQ12S03-2546WT
YMC-Pack Pro C18	2.1	AS12S03-15Q1QT	AS12S03-25Q1QT
	3.0	AS12S03-1503QT	AS12S03-2503QT
	4.6	AS12S03-1546WT	AS12S03-2546WT
Hydrosphere C18	2.1	HS12S03-15Q1QT	HS12S03-25Q1QT
	3.0	HS12S03-1503QT	HS12S03-2503QT
	4.6	HS12S03-1546WT	HS12S03-2546WT
Meteoric Core C18 BIO	2.1	CAW16SQ7-15Q1PT	—
	3.0	CAW16SQ7-1503PT	—
	4.6	CAW16SQ7-1546PT	—

12/20 nm, 3 μ m analytical columns, C8 & C4

Phase	Column ID [mm]	Column length [mm]	
		150	250
YMC-Pack C ₈	2.1	OC12S03-15Q1QT	—
	3.0	OC12S03-1503QT	OC12S03-2503QT
	4.6	OC12S03-1546WT	OC12S03-2546WT
YMCbasic (eq. C8)	2.1	BA99S03-15Q1QT	—
	3.0	BA99S03-1503QT	BA99S03-2503QT
	4.6	BA99S03-1546WT	BA99S03-2546WT
YMC-Pack C ₄	2.1	BU12S03-15Q1QT	—
	3.0	BU12S03-1503QT	BU12S03-2503QT
	4.6	BU12S03-1546WT	BU12S03-2546WT

Guard Columns are available for the different column dimensions. For more details please contact us: Phone 02064-427-0 or email info@ymc.de.

Ordering Information

12 nm, 5 µm analytical columns, C18

Phase	Column ID [mm]	Column length [mm]	
		150	250
YMC-Triart C18	2.1	TA12S05-15Q1PTH	—
	3.0	TA12S05-1503PTH	—
	4.6	TA12S05-1546PTH	TA12S05-2546PTH
YMC-Triart C8	2.1	TO12S05-15Q1PTH	—
	3.0	TO12S05-1503PTH	—
	4.6	TO12S05-1546PTH	TO12S05-2546PTH
YMC-Pack ODS-A (C18)	2.1	AA12S05-15Q1QT	AA12S05-25Q1QT
	3.0	AA12S05-1503QT	AA12S05-2503QT
	4.6	AA12S05-1546WT	AA12S05-2546WT
YMC-Pack ODS-AQ (C18)	2.1	AQ12S05-15Q1QT	AQ12S05-25Q1QT
	3.0	AQ12S05-1503QT	AQ12S05-2503QT
	4.6	AQ12S05-1546WT	AQ12S05-2546WT
YMC-Pack Pro C18	2.1	AS12S05-15Q1QT	AS12S05-25Q1QT
	3.0	AS12S05-1503QT	AS12S05-2503QT
	4.6	AS12S05-1546WT	AS12S05-2546WT
Hydrosphere C18	2.1	HS12S05-15Q1QT	HS12S05-25Q1QT
	3.0	HS12S05-1503QT	HS12S05-2503QT
	4.6	HS12S05-1546WT	HS12S05-2546WT

12/20 nm, 5 µm analytical columns, C8 & C4

Phase	Column ID [mm]	Column length [mm]	
		150	250
YMC-Pack C ₈	2.1	OC12S05-15Q1QT	OC12S05-25Q1QT
	3.0	OC12S05-1503QT	OC12S05-2503QT
	4.6	OC12S05-1546WT	OC12S05-2546WT
YMCbasic (eq. C8)	2.1	BA99S05-15Q1QT	BA99S05-25Q1QT
	3.0	BA99S05-1503QT	BA99S05-2503QT
	4.6	BA99S05-1546WT	BA99S05-2546WT
YMC-Pack C ₄	2.1	BU12S05-15Q1QT	BU12S05-25Q1QT
	3.0	BU12S05-1503QT	BU12S05-2503QT
	4.6	BU12S05-1546WT	BU12S05-2546WT
YMC-Pack PROTEIN-RP (eq. C4)	2.1	PR99S05-15Q1QT	PR99S05-25Q1QT
	3.0	PR99S05-1503QT	PR99S05-2503QT
	4.6	PR99S05-1546WT	PR99S05-2546WT

For other dimensions please refer to page 352-353



Ordering Information

12/20 nm, 5 µm semi-preparative columns

Phase	Column ID [mm]	Column length [mm]	
		150	250
YMC-Triart C18*	10	TA12S05-1510WT	TA12S05-2510WT
	20	TA12S05-1520WX	TA12S05-2520WX
	30	TA12S05-1530WX	TA12S05-2530WX
YMC-Triart C8*	10	TO12S05-1510WT	TO12S05-2510WT
	20	TO12S05-1520WX	TO12S05-2520WX
	30	TO12S05-1530WX	TO12S05-2530WX
YMC-Pack ODS-A (C18)*	10	AA12S05-1510WT	AA12S05-2510WT
	20	AA12S05-1520WX	AA12S05-2520WX
	30	AA12S05-1530WX	AA12S05-2530WX
YMC-Pack ODS-AQ (C18)*	10	AQ12S05-1510WT	AQ12S05-2510WT
	20	AQ12S05-1520WX	AQ12S05-2520WX
	30	AQ12S05-1530WX	AQ12S05-2530WX
YMC-Pack Pro C18*	10	AS12S05-1510WT	AS12S05-2510WT
	20	AS12S05-1520WX	AS12S05-2520WX
	30	AS12S05-1530WX	AS12S05-2530WX
Hydrosphere C18*	10	HS12S05-1510WT	HS12S05-2510WT
	20	HS12S05-1520WX	HS12S05-2520WX
	30	HS12S05-1530WX	HS12S05-2530WX
YMC-Pack C ₈	10	OC12S05-1510WT	OC12S05-2510WT
	20	OC12S05-1520WT	OC12S05-2520WT
	30	OC12S05-1530WT	OC12S05-2530WT
YMCbasic (eq. C8)*	10	BA99S05-1510WT	BA99S05-2510WT
	20	BA99S05-1520WX	BA99S05-2520WX
	30	BA99S05-1530WX	BA99S05-2530WX
YMC-Pack C ₄	10	BU12S05-1510WT	BU12S05-2510WT
	20	BU12S05-1520WT	BU12S05-2520WT
	30	BU12S05-1530WT	BU12S05-2530WT
YMC-Pack PROTEIN-RP (eq. C4)	10	PR99S05-1510WT	PR99S05-2510WT
	20	PR99S05-1520WT	PR99S05-2520WT
	30	PR99S05-1530WT	PR99S05-2530WT

Guard Columns are available for the different column dimensions.
For more details please contact your local YMC subsidiary.

* Columns with 20/30 mm ID available in YMC-Actus hardware. For further information on YMC-Actus please refer to page 65.

For further information about our preparative bulk materials please refer to page 304-317.

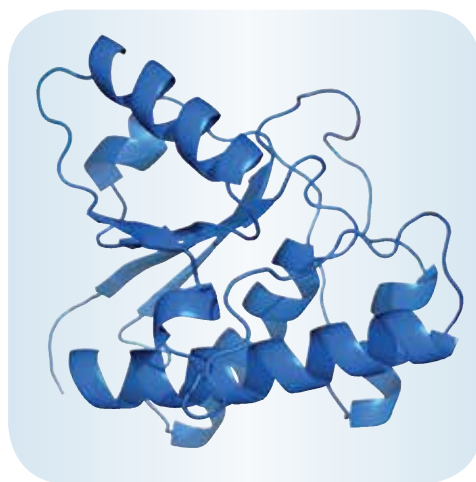
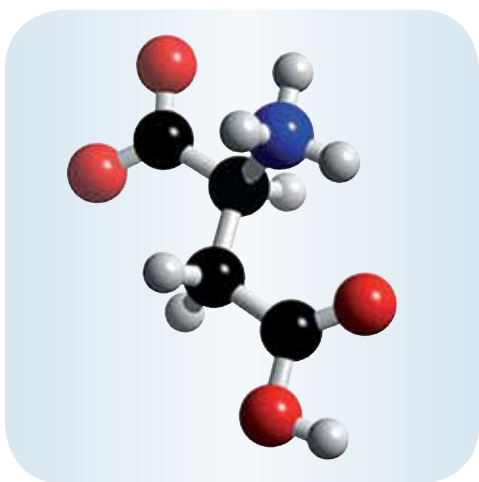

NP/
HILIC

NP / HILIC

Hydrophilic Interaction Chromatography (HILIC)

Hydrophilic Interaction Chromatography is a technique which has attracted more and more attention because it offers an alternative approach for the separation of highly polar compounds. The method itself, although it has been known for more than 25 years, has become more popular recently due to the introduction of several specialised HILIC phases. However it is not so well known that HILIC separations can be accomplished using any highly polar stationary phase.

This opens up a large range of materials which are suitable for HILIC separations. HILIC separations traditionally use a highly polar stationary phase and a non polar mobile phase e.g. functionalised silica with a hydrophilic coating and an acetonitrile/water mixture (90/10) for small molecules but separations of larger biomolecules is becoming increasingly more popular.

YMC Columns for HILIC	YMC-Pack Silica	YMC-Pack PVA-Sil	YMC-Pack Polyamine II	YMC-Pack Amino	YMC-Pack Diol	YMC-Triart Diol-HILIC
Particle size / μm	3; 5	5	5	3; 5	5	1.9; 3; 5
Pore size / nm	6; 12; 20; 30	12	12	12	12; 20; 30	12
pH range	2.0 - 7.5	2.0 - 9.5	2.0 - 7.5	2.0 - 7.5	2.0 - 7.5	2.0 - 10.0

Nucleosides and bases

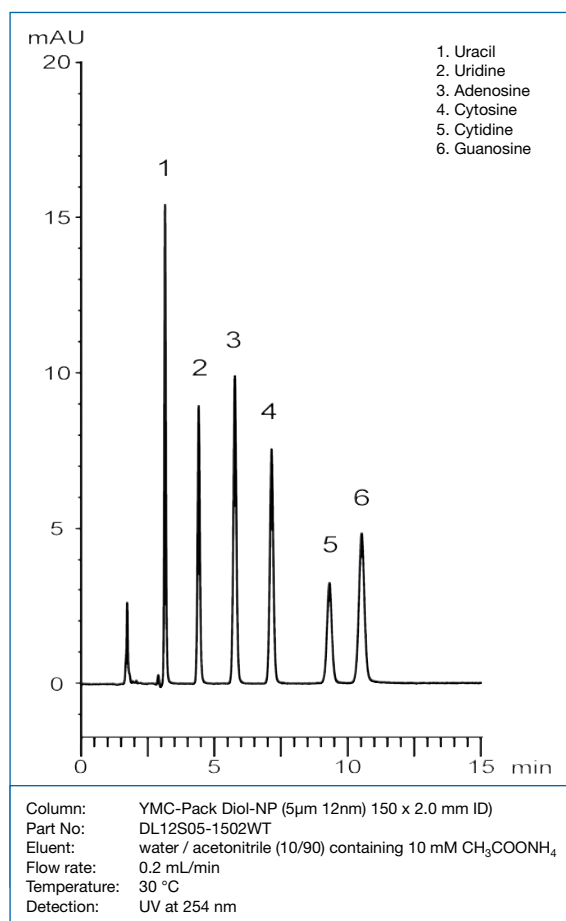

Outstanding Retention and Resolution with YMC HILIC!

YMC-Pack Polyamine II

YMC-Pack Polyamine II is a unique phase, based on ultrapure YMC silica as a support material. The functionality of the stationary phase is achieved by a covalently bonded polymer layer containing secondary (2°) and tertiary (3°) amino groups. The 2° and 3° amino groups of YMC-Pack Polyamine II are only weakly nucleophilic, exhibiting a significantly reduced reactivity towards carbonyl compounds.

Therefore, unlike conventional amino phases with primary n-propylamino ligands, YMC-Pack Polyamine II does not form Schiff bases or other stable condensation products. In addition, the 2° and 3° amino groups of the polymer layer are to a large extent resistant to oxidation and hydrolysis (as shown in the figure below).

Stability of amino type packings

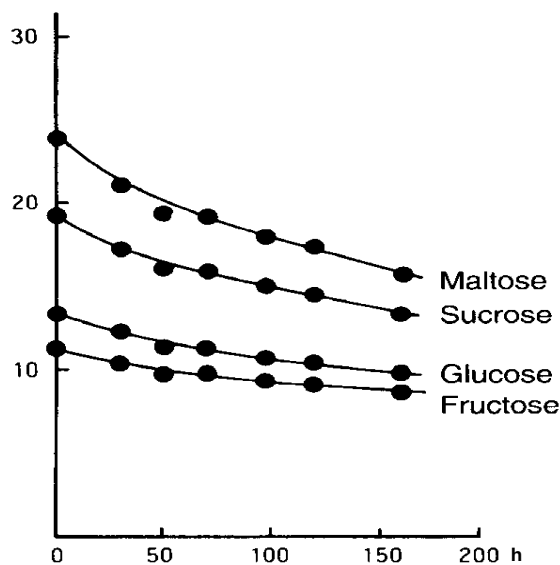

a) conventional amino phase

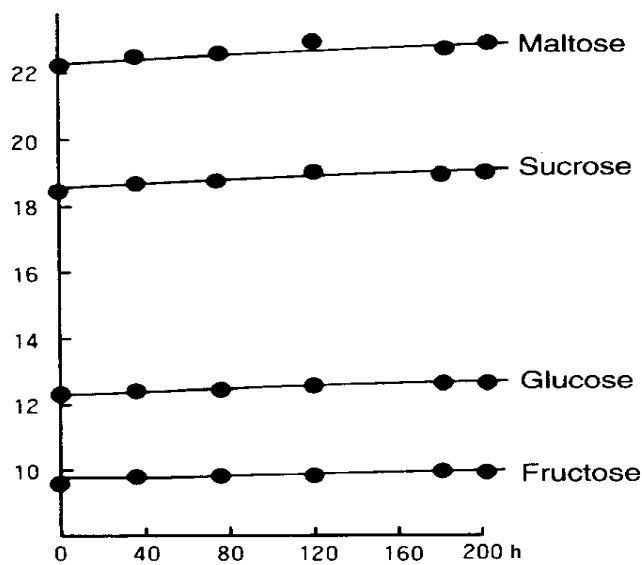

b) YMC-Pack Polyamine II

Applications

Mono- and Di-saccharides

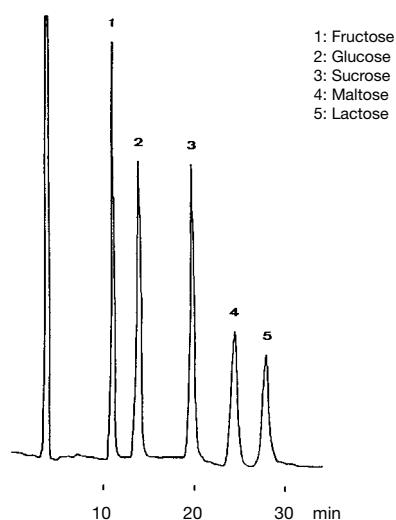

Column: YMC-Pack Polyamine II (5 μ m) 250 x 4.6 mm ID
 Part No.: PB12S05-2546WT
 Eluent: ACN / H₂O = 75/25
 Flow rate: 1.0 mL/min
 Detection: RI, 32x10⁻⁸ RIU/FS
 Temperature: 26 °C

Malto-oligosaccharides

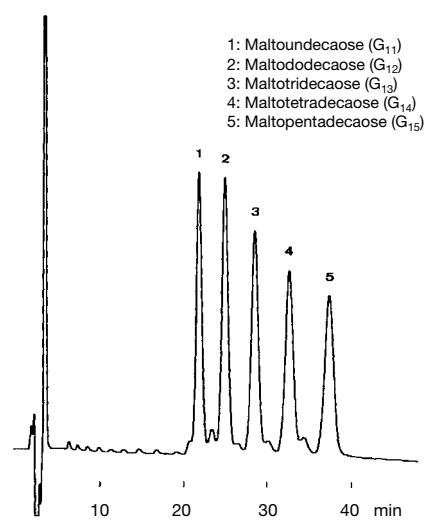

Column: YMC-Pack Polyamine II (5 μ m) 250 x 4.6 mm ID
 Part No.: PB12S05-2546WT
 Eluent: ACN / H₂O = 55/45
 Flow rate: 1.0 mL/min
 Detection: RI, 32 x 10⁻⁶ RIU/FS
 Temperature: 26 °C

YMC-Pack Polyamine II

Pyridylamino (PA)-Sugar chains

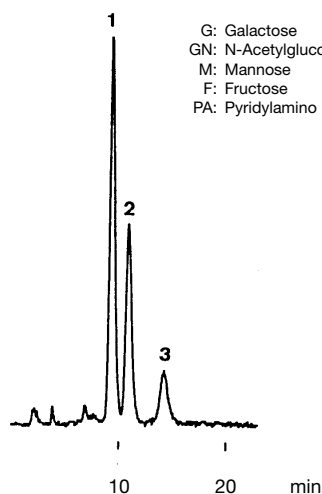

1:PA Sugar Chain 014, N-Acetylglucosamine-type
agalacto tetraantennary

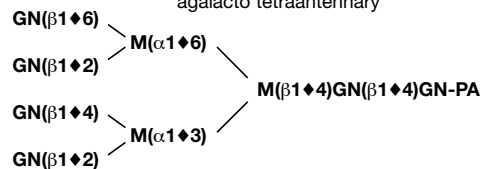

2:PA Sugar Chain 001, N-Acetylglucosamine-type
biantennary

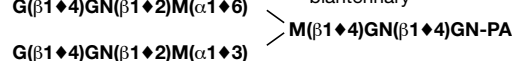

3:PA Sugar Chain 002, N-Acetylglucosamine-type

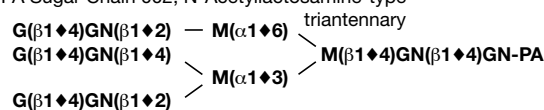

Column: YMC-Pack Polyamine II (5 μm) 150 x 4.6 mm ID
 Part No.: PB12S05-1546WT
 Eluent: methanol / $\text{NH}_4\text{H}_2\text{PO}_4$ (20 mM) = 80/20
 Flow rate: 1.0 mL/min
 Detection: fluorescence, Ex.320 nm, Em. 400 nm, 4 mV/FS
 Temperature: 37 $^\circ\text{C}$

Ordering Information

YMC-Pack Polyamine II, 12 nm, 5 μm

Phase dimension	Column ID [mm]	Column length [mm]					Guard cartridges* with 10 mm length [pack of 5]
		30 (WT) / 33 (QT)	50	100	150	250	
12 nm 5 μm	2.1	PB12S05-H3Q1QT	PB12S05-05Q1QT	PB12S05-10Q1QT	PB12S05-15Q1QT	PB12S05-25Q1QT	PB12S05-01Q1GC
	3.0	PB12S05-H303QT	PB12S05-0503QT	PB12S05-1003QT	PB12S05-1503QT	PB12S05-2503QT	PB12S05-0103GC
	4.0	PB12S05-H304QT	PB12S05-0504QT	PB12S05-1004QT	PB12S05-1504QT	PB12S05-2504QT	PB12S05-0104GC
	4.6	PB12S05-0346WT	PB12S05-0546WT	PB12S05-1046WT	PB12S05-1546WT	PB12S05-2546WT	PB12S05-0104GC

*Guard cartridge holder required, part no. XPGCH-Q1

For more details please contact us: Phone 02064-427-0 or E-Mail info@ymc.de.

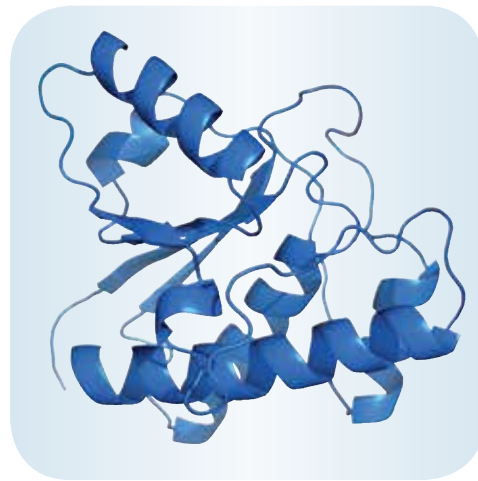
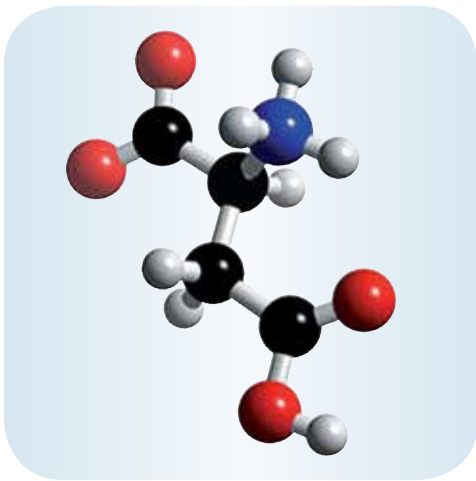

GLASS
COLUMNS

ECO Glass Columns

- biocompatible
- solvent resistant version (optional)
- easy to use
- low temperature application
- 2 adjustable length plungers (Multivario) supplied on request
- compatible with any LC system
- water-jacketed version available on request
- FDA, BSE/TSE certificates available

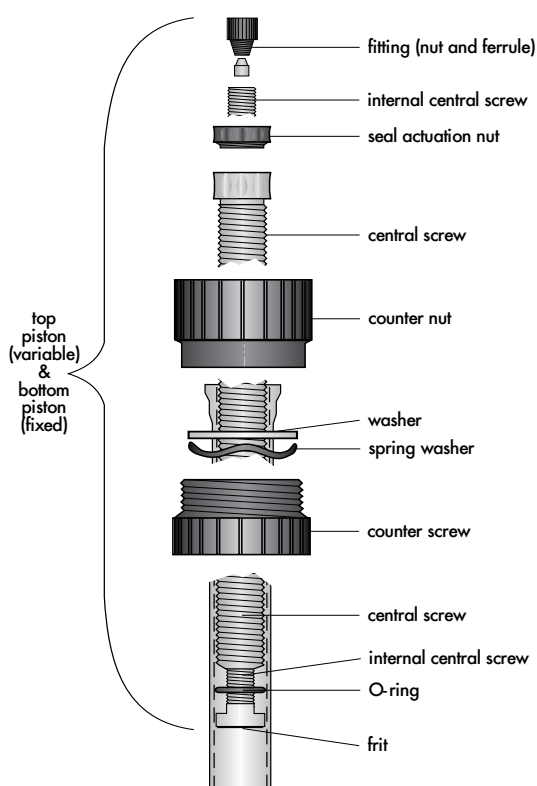

ECO Column ID 10-50 mm

General

ECO columns are glass columns for almost all types of soft gel and low pressure (pressure limit 5 - 30 bar) liquid chromatography applications. With a choice of one or two adjustable length plungers, they are available in two forms: AB (aqueous buffer) for use with aqueous buffers and cold room applications and SR (solvent resistant) for all forms of normal and reversed phase chromatography.

ECO columns are produced by high-precision CNC manufacturing. They are competitively priced and equipped with a screw-lock system which makes it possible to open and seal the column simply and quickly. Each column passes a quality control pressure test. A water-jacketed option can be supplied on request.

Versions available

Version	Temperature Range [°C]	Plunger	Seal	Frit
ECO AB (Aqueous Buffer)	4 - 40	POM	Viton® O-ring EPDM	Porous glass (ID 10 - 50 mm) Polyethylene (ID 70 - 80 mm)
ECO SR (Solvent Resistant)	4 - 40	PVDF	Kalrez® O-ring	Porous glass (ID 10 - 50 mm) Stainless steel (ID 70 - 80 mm)

ECO Glass Columns

Characteristics

- Pressure limit: 5 - 30 bar (depending on diameter)
- Temperature range: aqueous buffer version (AB): 4 - 40 °C
solvent resistant version (SR): 4 - 40 °C
- Wetted parts: borosilicate glass
aqueous buffer version (AB): POM, sintered glass frit and Viton® seal (ID 10 - 50 mm)
POM, polyethylene frit and EPDM seal (ID 70 - 80 mm)
solvent resistant version (SR): PVDF, sintered glass frit and Kalrez® seal (ID 10 - 50 mm)
PVDF, stainless steel frit and Kalrez® seal (ID 70 - 80 mm)
- Diameters: 10 mm, 15 mm, 25 mm, 50 mm, 70 mm, 80 mm
- Bed lengths: 120 mm, 200 mm, 450 mm, 750 mm, 1000 mm
- Height adjustment: Adjustable plunger provides up to 120 mm bed height adjustment (2 adjustable plungers supplied on request).
- Connections: The columns are supplied with different adaptors to allow direct connection to any LC-system.

Specifications

ID [mm]*	Pressure limit [bar]	Vario		Multivario	
		Bed length [mm]	Volume [mL]	Bed length [mm]	Volume [mL]
10	30	0-120	0-9.4	0-120	0-9.4
		80-200	6.3-16	0-200	0-16
		330-450	26-35	210-450	17-35
		630-750	50-59	510-750	40-59
		880-1000	69-79	760-1000	60-79
15	25	0-120	0-21	0-120	0-21
		80-200	14-35	0-200	0-35
		330-450	58-80	210-450	37-80
		630-750	111-133	510-750	90-133
		880-1000	156-177	760-1000	134-177
25	15	0-120	0-59	0-120	0-59
		80-200	39-98	0-200	0-98
		330-450	162-221	210-450	103-221
		630-750	309-368	510-750	250-368
		880-1000	432-491	760-1000	373-491
50	10	0-120	0-236	0-120	0-236
		80-200	157-393	0-200	0-393
		330-450	648-884	210-450	412-884
		630-750	1237-1473	510-750	1001-1473
		880-1000	1728-1964	760-1000	1492-1964
70	5	—	—	0-120	0-462
		—	—	0-200	0-770
		—	—	90-450	356-1732
		—	—	390-750	1501-2886
		—	—	640-1000	2463-3848
80	5	—	—	0-120	0-603
		—	—	0-200	0-1005
		—	—	90-450	452-2262
		—	—	390-750	1960-3770
		—	—	640-1000	3217-5026

* Columns with inner diameter of 20 and 32 mm are available upon request

Accessories supplied

All columns: 1x frit removal tool / 2x plugs, PTFE (1/4"-28G)

and for each specific diameter the following tubing, nuts and ferrules:

ID 10–15 mm: 1x 1m FEP-tubing (0.8 x 1.6 mm); 4x 1/4"-28G nuts and ferrules (collapsible) for 1/16" tubing;
2x M6 nuts and ferrules for 1/16" tubing and 2x 10-32 nuts and ferrules for 1/16" tubing

ID 25–80 mm: 1x 1m FEP-tubing (1.6 or 2.4 x 3.2 mm); 4x 1/4"-28G nuts and ferrules (collapsible) for
1/8" tubing and 2x M6 nuts and ferrules for 1/8" tubing

Ordering guide

The part numbers for the columns contain information on the column type, inner diameter, column length, plunger type, frit porosity and seal (O-ring) material.

Inner diameter ID [mm]*	Pressure limit [bar]	Order code
10	30	ECO10/
15	25	ECO15/
25	15	ECO25/
50	10	ECO50/
70	5	ECO70/
80	5	ECO80/

* Columns with inner diameter of 20 and 32 mm are available upon request

Max. bed length [mm]	Order code
120	120
200	200
450	450
750	750
1000	999
Longer columns are available on request.	

No. of adjustable plungers	Order code
1 adjustable plunger (Vario)	V
2 adjustable plungers (Multivario)	M
up to 120 mm bed variability each	

Frit porosity [μm]	Order code
10	0
16 - 40	3
40 - 100	4
Other frit porosities are available on request.	

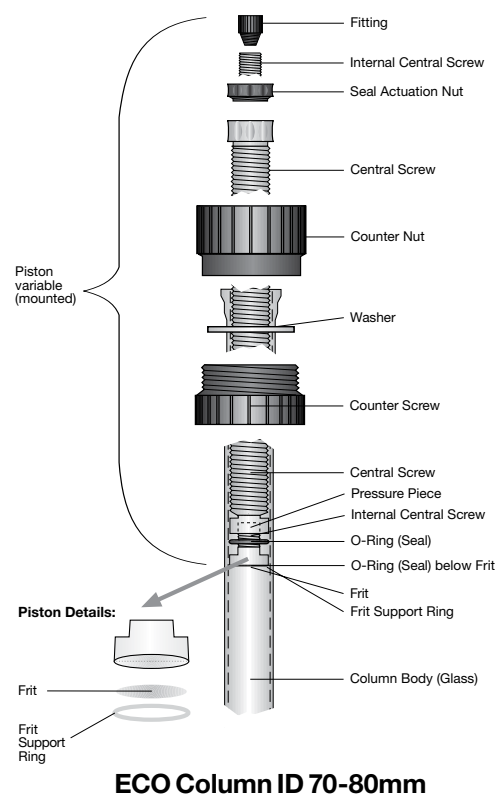

Column version	Seal O-ring material	Order code
ECO AB (Aqueous Buffer)	Viton® / EPDM	V
ECO SR (Solvent Resistant)	Kalrez®	K

Option	Order code
Water-jacket version*	-K
*(only in combination with Multi Vario plunger)	

Ordering guide

Examples

To order an aqueous buffer ECO column with an inner diameter of 15 mm, a column length of 120 mm, with 1 adjustable plunger and a frit porosity of 16 - 40 μm , a Viton O-ring and without the water-jacket option, please use the corresponding part number ECO15/120V3V.

Part Number: ECO15/120V3V

Example	ECO	15/	120	V	3	V
Column type	ECO					
Inner diameter		15/				
Max. bed length			120			
Plunger type				V		
Frit porosity					3	
Seal O-ring material						V

To order a solvent resistant ECO column with an inner diameter of 10 mm, a column length of 120 mm, with 2 adjustable plungers and a frit porosity of 10 μm , a Kalrez O-ring and with the water-jacket option, please use the corresponding part number ECO10/120M0K-K.

Part Number: ECO10/120M0K-K

Example	ECO	10/	120	M	0	K	-K
Column type	ECO						
Inner diameter		10/					
Column length			120				
Plunger type				M			
Frit porosity					0		
Seal O-ring material						K	
Water-jacket version							-K

Packing Adaptors

The ECO series packing adaptors consist of a column coupler and an empty glass body. These must be of the same diameter as the column to be packed and must only be used as packing adaptors, not for extending the length of a column body. The length of the additional glass body used should be selected to allow:

- Double the volume of slurry compared to the required packed bed volume if packing silica materials
- Triple the volume of slurry for softer packing materials

The product manual supplied with each column contains detailed examples of dry packing and slurry packing techniques.

For ordering information please see next page.

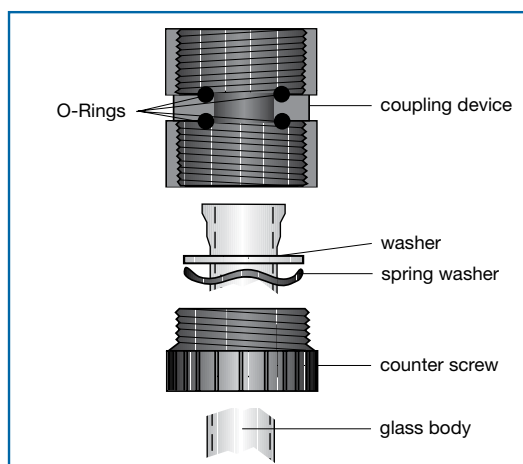

column coupler

Ordering information for ECO packing adaptors

Inner Diameter*	Description	Length	Part Number
10	Column Coupler (no Glass Body) including Viton® O-Ring		ECO10KU/V-2
15	Column Coupler (no Glass Body) including Viton® O-Ring		ECO15KU/V-2
25	Column Coupler (no Glass Body) including Viton® O-Ring		ECO25KU/V-2
50	Column Coupler (no Glass Body) including Viton® O-Ring		ECO50KU/V-2
70	Column Coupler (no Glass Body) including EPDM O-Ring		ECO70KU/E-2
80	Column Coupler (no Glass Body) including EPDM O-Ring		ECO80KU/E
10	Glass Body for use with Column Coupler	120	ECO10/120
		200	ECO10/200
		450	ECO10/450
		750	ECO10/750
		1000	ECO10/999
15	Glass Body for use with Column Coupler	120	ECO15/120
		200	ECO15/200
		450	ECO15/450
		750	ECO15/750
		1000	ECO15/999
25	Glass Body for use with Column Coupler	120	ECO25/120
		200	ECO25/200
		450	ECO25/450
		750	ECO25/750
		1000	ECO25/999
50	Glass Body for use with Column Coupler	120	ECO50/120
		200	ECO50/200
		450	ECO50/450
		750	ECO50/750
		1000	ECO50/999
70	Glass Body for use with Column Coupler	120	ECO70/120
		200	ECO70/200
		450	ECO70/450
		750	ECO70/750
		1000	ECO70/999
80	Glass Body for use with Column Coupler	120	ECO80/120
		200	ECO80/200
		450	ECO80/450
		750	ECO80/750
		1000	ECO80/999

* Column Couplers for columns with inner diameter of 20 and 32 mm are available upon request

ECO^{PLUS} Glass Columns

- Suitable for universal use
- Biocompatible
- Simple to use
- Compatible to any LC system
- Height-adjustable pistons at both ends
- Suitable for cold rooms from 4 - 40 °C (with polyethylene piston and EPDM O ring)
- SR-Version resistant to organic solvents (SR = Solvent Resistant)
- FDA, BSE/TSE certificates available



General

Biochromatography is widely applied in high-performance downstream processing techniques that can be used for a range of compounds, such as proteins, peptides or nucleic acids. When using various chromatographic techniques such as ion exchange, affinity or gel permeation chromatography, increasingly high-performance separation media are used and, as a result, higher demands are made on the quality of the column hardware.

ECO^{PLUS} glass columns meet the highest criteria for professional laboratory use. Particular attention has been paid to the column volume ranges that are as wide as possible (0.4 - 982 mL)

and to the high pressure resistance (up to 80 bar / 1160 psi), so that high flow rates and performance/efficiency can be achieved.

We have selected high-quality, inert materials to make sure ECO^{PLUS} glass columns are biocompatible and offer the best conditions for high recovery with no loss of bio-activity of your biomolecules. Thanks to the "Quick-Lock" seal and the two adjustable pistons, the columns are fully adjustable and easy to use.

Given the wide range of diameters, frit porosities and lengths available, you can use ECO^{PLUS} glass columns for the most diverse of applications.

„Quick-Lock“ Fitting



No more than a quarter turn is needed to seal the column.

Piston height adjustment is done by turning the locked "Quick-Lock" Fitting.

Application Examples

In reversed phase and adsorption chromatography, the possibilities for using glass columns are often limited due to high back pressures generated by small particles. The high pressure resistance of the ECO^{PLUS} glass columns allow you to achieve high flow rates for demanding separations. The example shows that this enables a considerable acceleration of the separation, which means that you can achieve significant time savings.

Separation of a standard test mixture of proteins

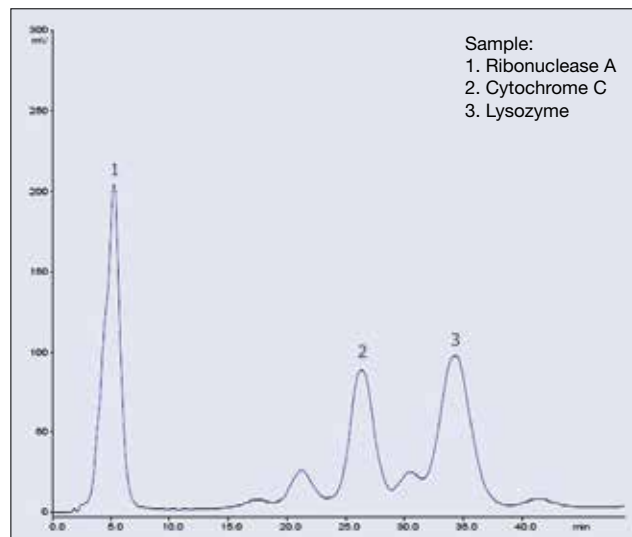

Column: ECO^{PLUS} 250 x 15 mm ID
Stationary phase: YMC-BioPro S30, 30 µm (bed length 170 mm)
Mobile phase: A) 20 mM KH₂PO₄*K₂HPO₄ (pH 6.8)
B) 20 mM KH₂PO₄*K₂HPO₄ (pH 6.8) containing 0.5 M NaCl
Gradient: 40-80% B
Flow rate: 6 mL/min
Temperature: 25°C
Detection: UV at 220 nm
Injection: 100 µl

Example of application with reversed phase media

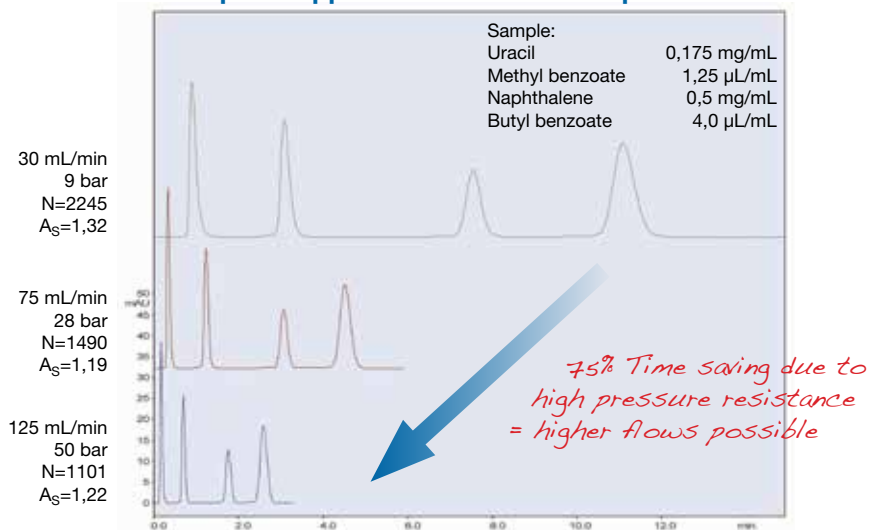

Column: ECO^{PLUS} 125 x 25 mm ID
Stationary phase: YMC*Gel ODS-AQ, 10 µm, 12 nm, 8 cm bed length
Flow rate: 30 mL/min - 75 mL/min - 125 mL/min
Mobile phase: ACN/H₂O (50:50)
Injection: 500 µL
Detection: UV at 254 nm

Product options

ECO^{PLUS} laboratory glass columns are routinely available in three different lengths (125, 250, and 500 mm) and three combinations of pistons (Short, Short/Long, Long) in order to accommodate different volume configurations.

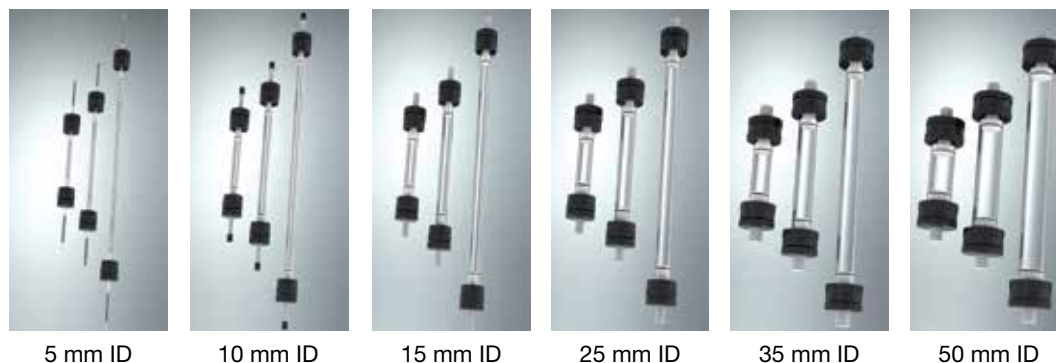

The modular construction allows for a range of piston variations to provide the ideal column volume.

Standard Version for Aqueous Buffers (AB)

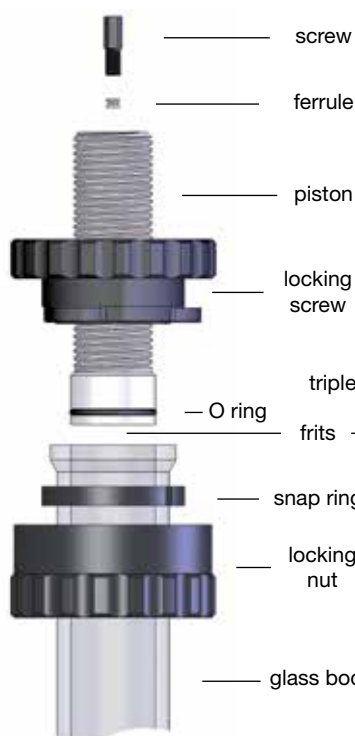

Optional Version Solvent Resistant (SR)



ECO^{PLUS} glass columns are multi-purpose columns for all liquid chromatography applications (with pressure limits of 30 to 80 bar (435 to 1160 psi) - depending on column diameter as shown in the table on the next page). ECO^{PLUS} glass columns are available in two versions:

Standard Version

(AB = Aqueous Buffer) for aqueous buffers and applications in cold rooms.

Optional Version

(SR = Solvent Resistant) for normal and reversed phase chromatography. The height-adjustable pistons (standard) at each end of the ECO^{PLUS} glass column with Teflon ribs (SR-version) are suitable for the entire spectrum of normal phase and reversed phase chromatography as well as biochromatography above ambient temperature.

All ECO^{PLUS} glass columns are made with high-precision CNC machines and undergo several rigorous quality controls before they are delivered.

ECO^{PLUS} Glass Columns

Versions available / materials used / components in contact with media

All the columns are made of borosilicate glass 3.3 (calibrated precision glass - KPG®)

Version*	Temperature range [°C]	max. Pressure [bar]	Piston	Seal	Frits
ECO ^{PLUS} AB (Aqueous Buffer)	4 - 40	ID 05 mm: 80 ID 10 mm: 80 ID 15 mm: 70 ID 25 mm: 50 ID 35 mm: 40 ID 50 mm: 30	Polyethylene	O ring EPDM (ethylene-propylene-diene-M-class rubber)	Column ID 5-50 mm: Polyethylene
ECO ^{PLUS} SR (Solvent Resistant)	16 - 40	ID 05 mm: 80 ID 10 mm: 50 ID 15 mm: 50 ID 25 mm: 50 ID 35 mm: 40 ID 50 mm: 25	PTFE (Teflon)	PTFE (Teflon)	Column ID 5-15 mm: sintered glass Column ID 25-50 mm: Stainless steel (SS)

* Material certificates for wetted parts are available upon request.

Specifications

ID [mm]	Short pistons		Short/long piston		Long pistons	
	Bed length [mm]	Volume [mL]	Bed length [mm]	Volume [mL]	Bed length [mm]	Volume [mL]
5	22 - 125 147 - 250 397 - 500	0.4 - 2.5 2.9 - 4.9 7.8 - 9.8	0 - 125 67 - 250 317 - 500	0 - 2.5 1.3 - 4.9 6.2 - 9.8	0 - 125 0 - 250 237 - 500	0 - 2.5 0 - 4.9 4.7 - 9.8
10	32 - 125 157 - 250 407 - 500	2.5 - 9.8 12 - 20 32 - 39	0 - 125 77 - 250 327 - 500	0 - 9.8 6.0 - 20 26 - 39	0 - 125 0 - 250 247 - 500	0 - 9.8 0 - 20 19 - 39
15	24 - 125 149 - 250 399 - 500	4.2 - 22 26 - 44 71 - 88	0 - 125 69 - 250 319 - 500	0 - 22 12 - 44 56 - 88	0 - 125 0 - 250 239 - 500	0 - 22 0 - 44 42 - 88
25	28 - 125 153 - 250 403 - 500	14 - 61 75 - 123 198 - 245	0 - 125 73 - 250 323 - 500	0 - 61 36 - 123 159 - 245	0 - 125 0 - 250 243 - 500	0 - 61 0 - 123 119 - 245
35	30 - 125 155 - 250 405 - 500	29 - 120 149 - 241 390 - 481	0 - 125 75 - 250 325 - 500	0 - 120 72 - 241 313 - 481	0 - 125 0 - 250 245 - 500	0 - 120 0 - 241 236 - 481
50	36 - 125 161 - 250 410 - 500	71 - 245 316 - 491 805 - 982	0 - 125 81 - 250 331 - 500	0 - 245 159 - 491 650 - 982	0 - 125 0 - 250 250 - 500	0 - 245 0 - 491 491 - 982

Standard accessories (included with the column)

All glass columns include: 1x frit ejector / 2x plugs, PTFE (1/4"-28G),

plus the screws, ferrules and capillaries required to link up to any LC system, depending on the tube ID:

ID 5 mm: 1x 1m ETFE 1/16" capillary tubing pre-assembled / 4x 1/4"-28G screws / ferrules for 1/16" tubing / 2x M6 screws / ferrules for 1/16" tubing / 2x 10-32 screws / ferrules for 1/16" tubing.

ID 10-15 mm: 1x 1m FEP 1/16" capillary tubing (0.8 x 1.6 mm) / 4x 1/4"-28G screws / ferrules for 1/16" tubing / 2x M6 screws / ferrules for 1/16" tubing / 2x 10-32 screws / ferrules for 1/16" tubing.

ID 25-50 mm: 1x 1m FEP 1/8" capillary tubing (1.6 x 3.2 mm) / 4x 1/4"-28G screws / ferrules for 1/8" tubing / 2x M6 screws / ferrules for 1/8" tubing.

ECO^{PLUS} Glass Columns

Accessories / Replacement parts

To allow packing of a glass column, you can use the ECO^{PLUS} column coupler to join a glass body to a column. For this to work, it must have the same inside diameter as the column. The length of the extra glass body required for column packing depends on the packing material being used and can be calculated from the packing instructions for the chosen packing material.

Column couplers consist of:

- ECO^{PLUS} connection screw with Teflon insert (assembled)
- Column coupler counter screw with snap ring
- Counter nut (bayonet) with snap ring
- AB-version has two sets (4 items) of Viton® O rings
- SR-version has two Kalrez® O rings

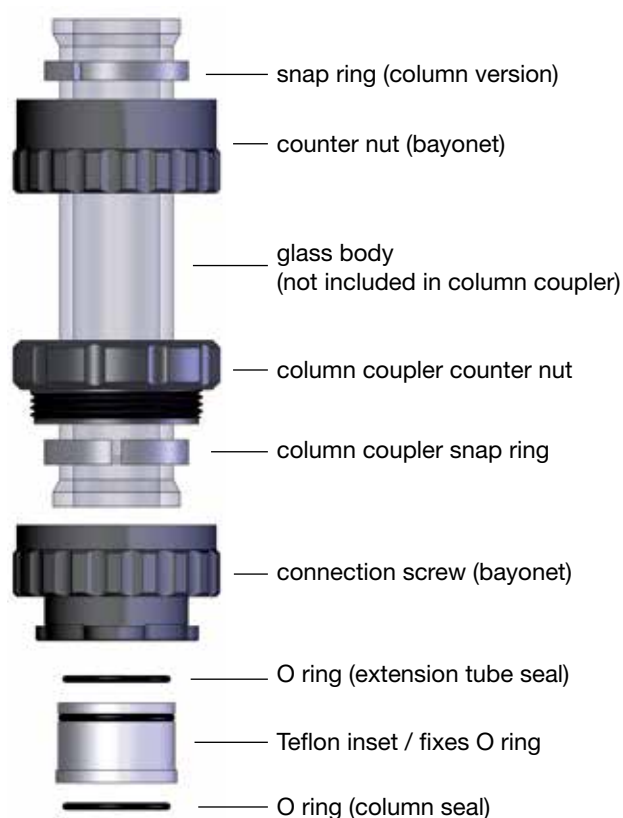

ECO^{PLUS} column coupler

Column ID [mm]	AB Version column couplers* Part No.	SR Version column couplers* Part No.
5	TAC05KU-AB	TAC05KU-SR
10	TAC10KU-AB	TAC10KU-SR
15	TAC15KU-AB	TAC15KU-SR
25	TAC25KU-AB	TAC25KU-SR
35	TAC35KU-AB	TAC35KU-SR
50	TAC50KU-AB	TAC50KU-SR

* the column coupler does not include a glass body: please order this separately

ECO^{PLUS} glass bodies

Column ID [mm]	max. bed length 125 mm Part No.	max. bed length 250 mm Part No.	max. bed length 500 mm Part No.
5	TAC05/125-2	TAC05/250-2	TAC05/500-2
10	TAC10/125-2	TAC10/250-2	TAC10/500-2
15	TAC15/125-2	TAC15/250-2	TAC15/500-2
25	TAC25/125-2	TAC25/250-2	TAC25/500-2
35	TAC35/125-2	TAC35/250-2	TAC35/500-2
50	TAC50/125-2	TAC50/250-2	TAC50/500-2

Ordering guide

The part number for an ECO^{PLUS} glass column consists the identification of the inner diameter, maximum bed length, piston set type, frit porosity and material, plus the model type (SR or AB version).

To order a solvent resistant ECO^{PLUS} glass column with an inner diameter of 25 mm, a maximum bed length of 500 mm, 2 short pistons and stainless steel frits with a porosity of 2 µm, the part number would be: TAC25/500S2-SR-2 (see example).

Combination options	TAC05/ (5 mm ID)	125 (125 mm max. bed length)	— Standard version has 2 short pistons: no product coding required; For other versions, please insert either:	PE Polyethylene (AB-Version)	2 (2 µm)	-AB-2 (aqueous buffer)
	TAC10/ (10 mm ID)			250 (250 mm max. bed length)		G Sintered glass (SR-Version with ≤ 15 mm ID)
	TAC15/ (15 mm ID)			S Stainless steel (SS) (SR-Version with ≥ 25 mm ID)	0 (10 µm)	
	TAC25/ (25 mm ID)	500 (500 mm max. bed length)	SL (1 short/1 long piston)			
	TAC35/ (35 mm ID)		or			
	TAC50/ (50 mm ID)		L (2 long pistons)			
Example	TAC25/	500		S	2	-SR-2
Inner diameter	25 mm					
max. bed length		500 mm				
Piston type						
Frit material				Stainless steel		
Frit porosity					2 µm	
Version						SR-Version

Pilot Glass and DAU Columns



For information on YMC Pilot glass columns and YMC DAU (dynamic axial compression) columns kindly inquire the corresponding brochures.



Chiral Columns

Content



CHIRAL ART Coated Polysaccharide
Derivatives Series 244-253

CHIRAL ART Immobilised Polysaccharide
Derivatives Series 254-261



YMC CHIRAL NEA(R)(S) 262-265

YMC CHIRAL CD BR 266-269

Contract Purification of Chiral Compounds..... 270

Ordering Information.....271-273

Introduction

HPLC Columns for Optical Isomer Separation

Chirality has become vitally important in the production of pharmaceuticals, agrochemicals, food and related products due to the different pharmacological or taste/odour effects which the different optical isomers can present. The pharmacological effects can range from no activity through undesirable effects to having potentially life threatening adverse effects. This has led to the development of highly efficient chiral stationary phases (CSP) for analytical and preparative scale separations.

If the CSP is available in two enantiomeric configurations the elution order of enantiomeric pairs can be reversed.

This is particularly useful when the two isomers are not present in equal quantities; a later eluting minor component can often be hidden by the tail of a major peak but on reversal of elution order can be totally resolved from the major component.

CHIRAL ART

Coated Polysaccharide Derivatives Series

- polysaccharide chiral selectors
- wide application range
- with high stability, also for SFC/SMB
- HPLC columns and preparative grade bulk media with particle sizes of 3, 5, 10 and 20 μm available
- extremely attractive pricing

Introduction

A family of coated chiral polysaccharide phases has been developed by YMC, designed to supply superior products which are competitively priced compared to established vendors. In addition – and typical of YMC – fully scalable preparative grades are available in large quantities.

Mobile phase and sample solvent

The silica packing material is coated with the polysaccharide derivative. Therefore trace quantities of a solvent which might potentially dissolve the polysaccharide derivative (eg. THF, acetone, ethyl acetate, chloroform, dichloromethane, DMSO, DMF, etc.) should be eliminated. These solvents must be avoided in the mobile phase and the sample solvent.

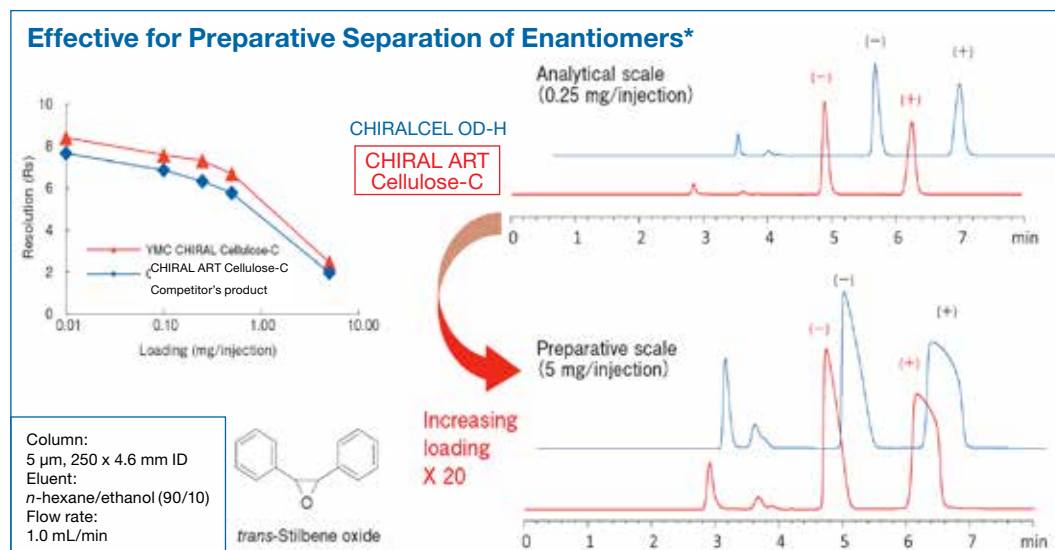

CHIRAL ART

Coated Polysaccharide Derivatives Series



Specifications	CHIRAL ART Amylose-C	CHIRAL ART Cellulose-C
Particle size	3, 5, 10, 20 µm	3, 5, 10, 20 µm
CHIRAL selector	Amylose tris (3,5-dimethylphenylcarbamate)	Cellulose tris (3,5-dimethylphenylcarbamate)
USP	L51	L40
Type	Coated type	Coated type
Separation mode	Normal Phase / SFC	Normal Phase / SFC
Shipping solvent	<i>n</i> -hexane / 2-propanol (90/10)	<i>n</i> -hexane / 2-propanol (90/10)
Temp. range	0-40 °C	0-40 °C
Pressure limit	30 MPa (4350 psi)	30 MPa (4350 psi)
Recommended flow rate	4.6 mm ID: 0.5 - 1.0 mL/min (Max. flow rate: 3.0 mL/min) 10 mm ID: 2.5 - 5.0 mL/min (Max. flow rate: 15 mL/min)	

Product Line-up

Product name	Particle size [µm]	Chiral selector	Type	Competitive product
CHIRAL ART Amylose-C	3 5	Amylose tris (3,5-dimethylphenylcarbamate)	Coated	CHIRALPAK® AD, AD-H, AD-3
CHIRAL ART Cellulose-C	10 20	Cellulose tris (3,5-dimethylphenylcarbamate)	Coated	CHIRALCEL® OD, OD-H, OD-3



Coated Polysaccharides

Enhanced stability using TFA

Stability evaluation with Warfarin*

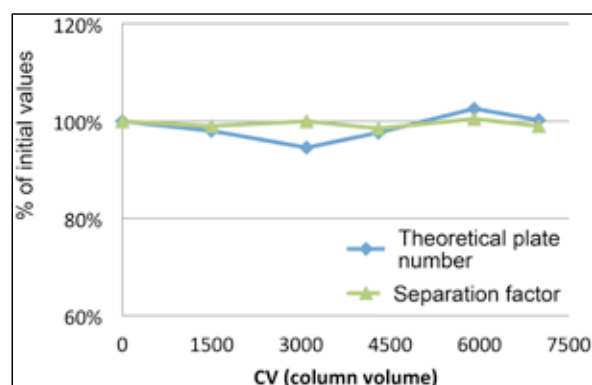
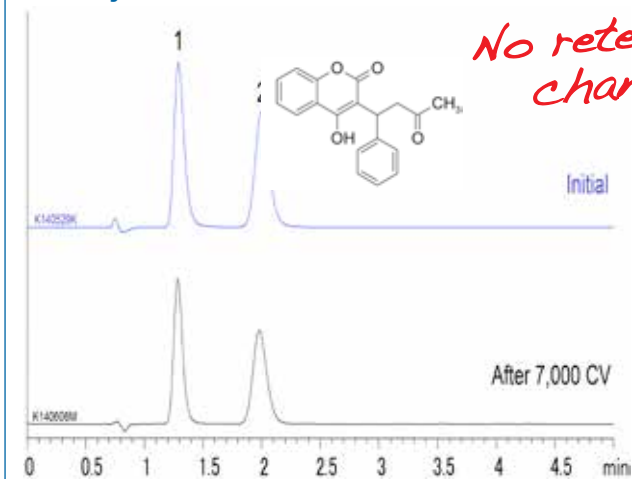

Column: CHIRAL ART Amylose-C (5 μ m) 50 x 3.0 mm ID
 Part No.: KAN99S05-0503WT
 Eluent: *n*-hexane / ethanol / TFA (70/30/0.1)
 Flow rate: 0.425 mL/min
 Temperature: 25°C
 Detection: UV at 254 nm

Repeated analysis of Ibuprofen*

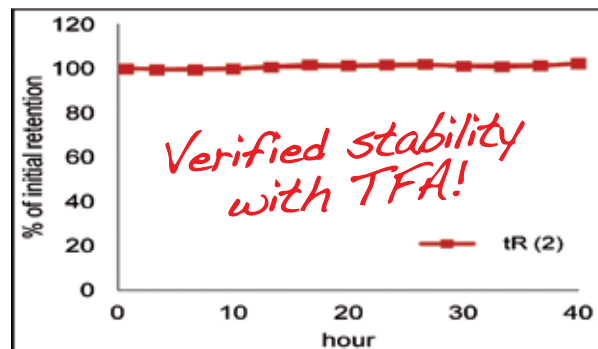
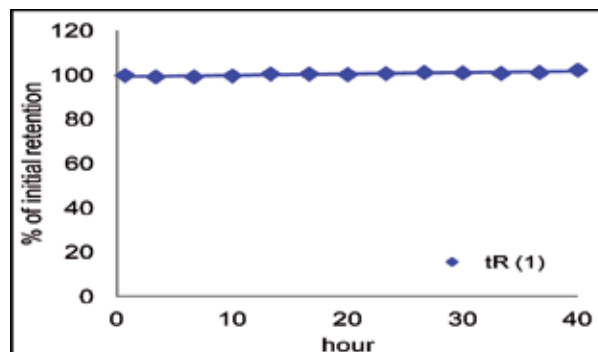
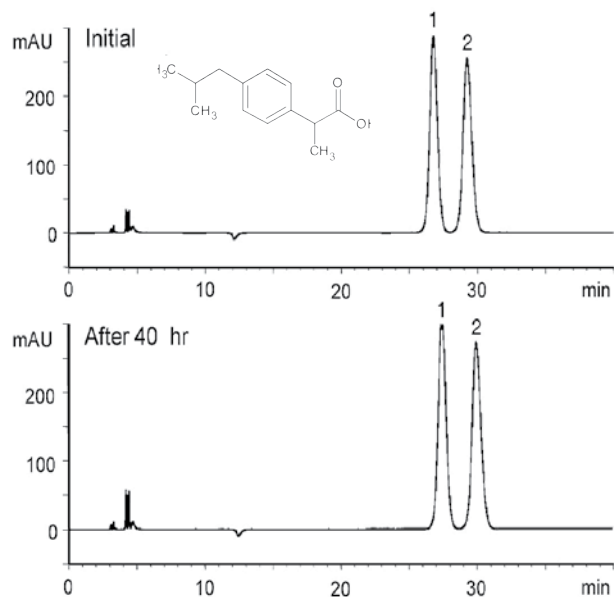

Column: CHIRAL ART Amylose-C (5 μ m) 250 x 4.6 mm ID
 Part No.: KAN99S05-2546WT
 Eluent: *n*-hexane / 2-propanol / TFA (99/1/0.1)
 Flow rate: 1.0 mL/min
 Temperature: 25°C
 Detection: UV at 220 nm
 Injection: 10 μ L (1 mg/mL)

TFA can be challenging for coated amylose phases with regards to stability and lifetime. CHIRAL ART Amylose-C however shows long-term stability using mobile phases containing TFA. The retention behaviour and column efficiency remain completely unaffected.

Coated Polysaccharides

Extended packing stability*

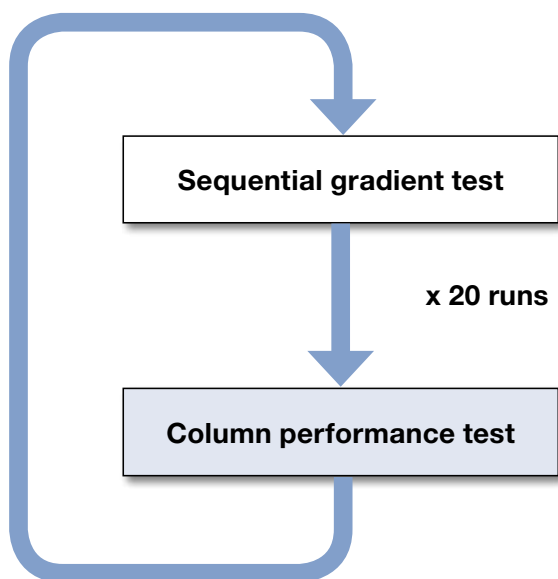

Sequential gradient test

Column: 5 μ m, 250 x 4.6 mm ID
 Eluent: A) *n*-hexane, B) ethanol
 0-100% B (0-15 min)
Flow rate: 3.0 mL/min
Pressure: 10-30 MPa/run
 Temperature: 37 °C

Column performance test

Column: 5 μ m, 250 x 4.6 mm ID
 Eluent: *n*-hexane/ethanol (90/10)
 Flow rate: 1.0 mL/min
 Temperature: 37 °C
 Detection: UV at 230 nm
 Sample: *trans*-Stilbene oxide

Amylose-C

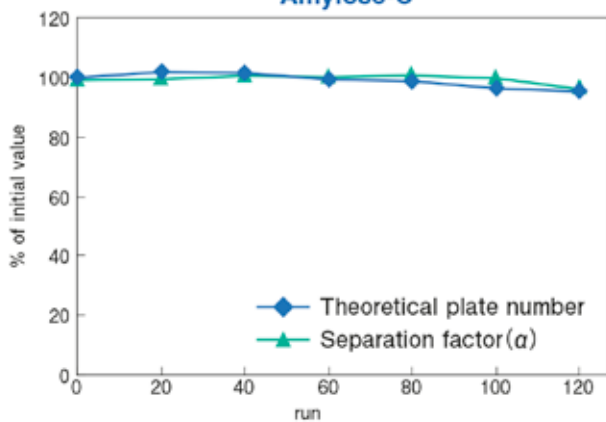

Cellulose-C

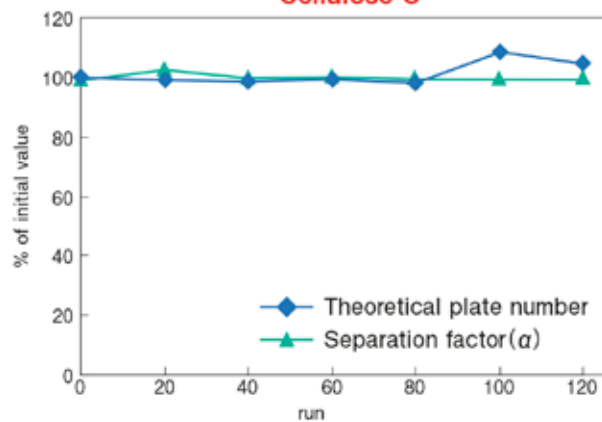

Coated Polysaccharides

Applications

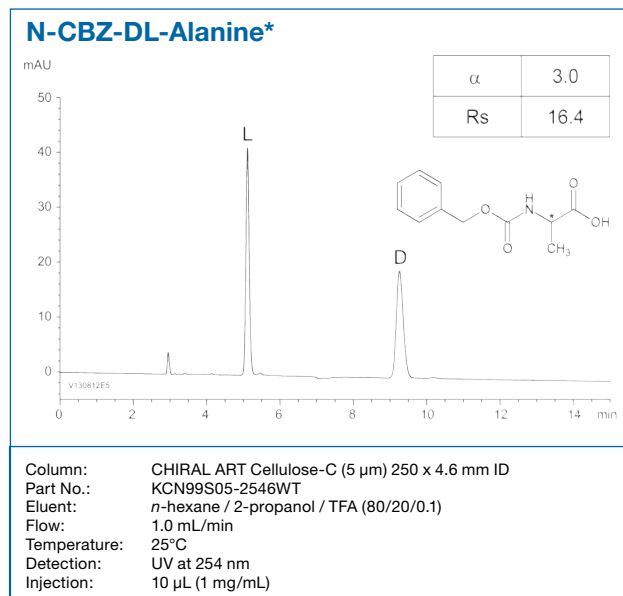
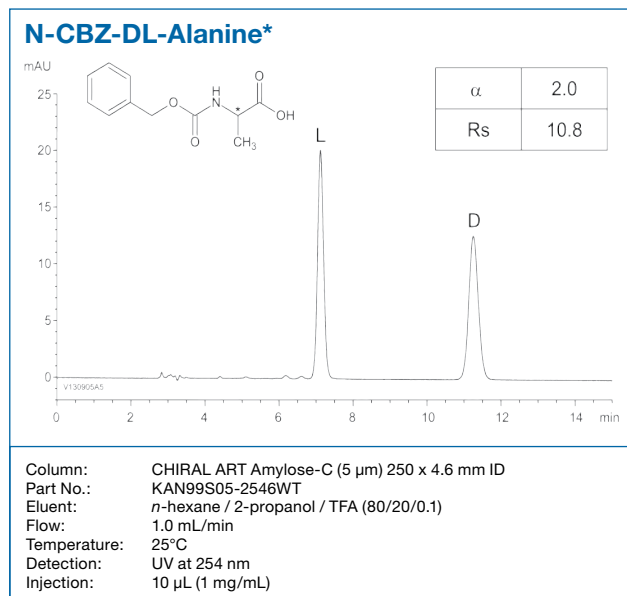
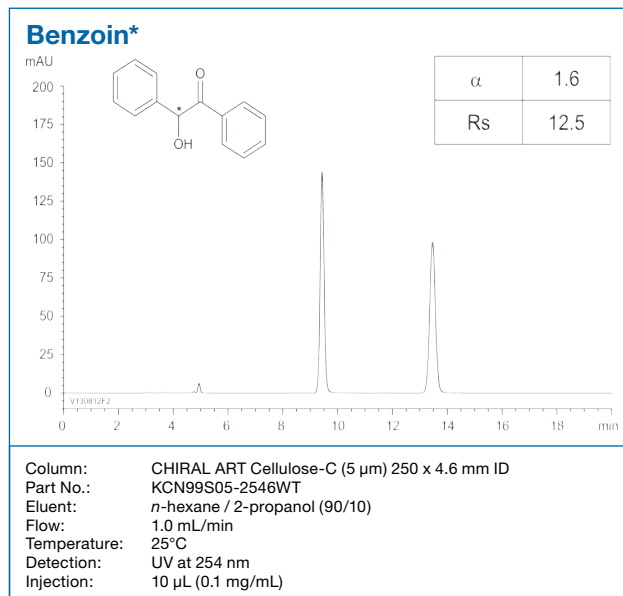
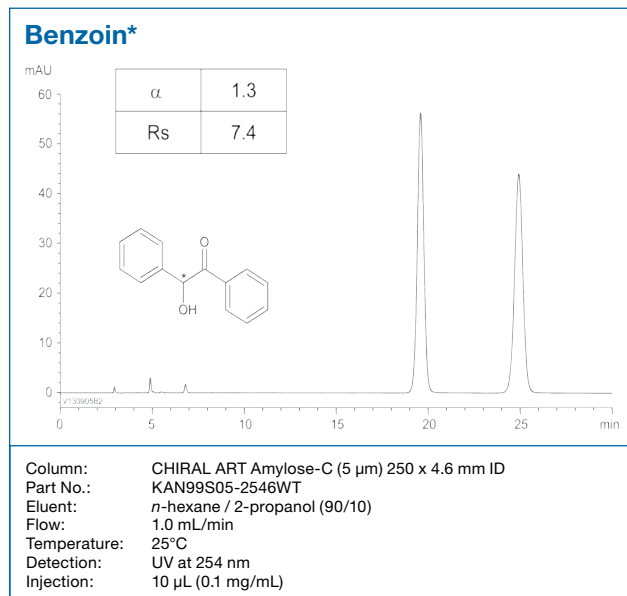

Coated Polysaccharides

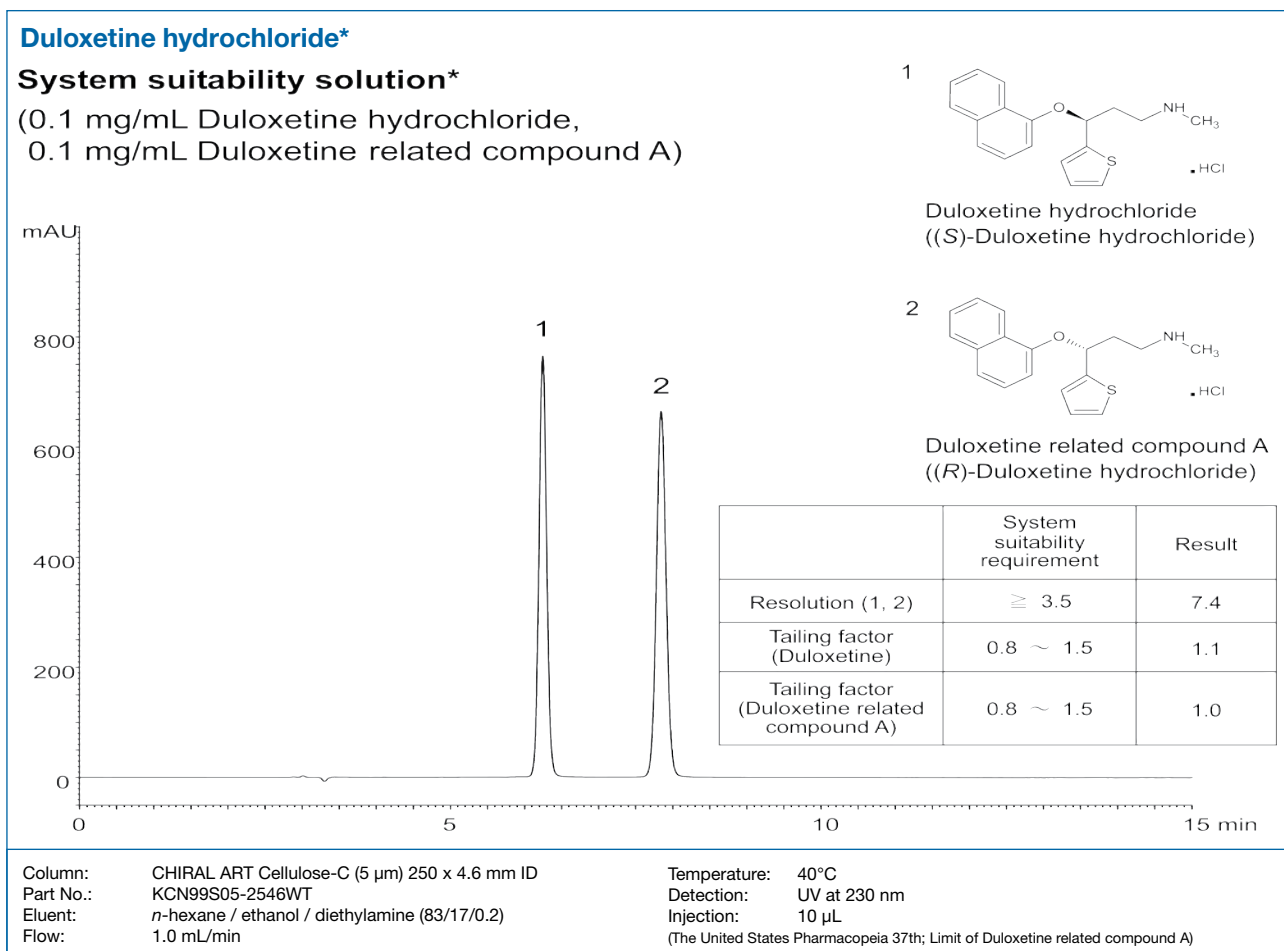
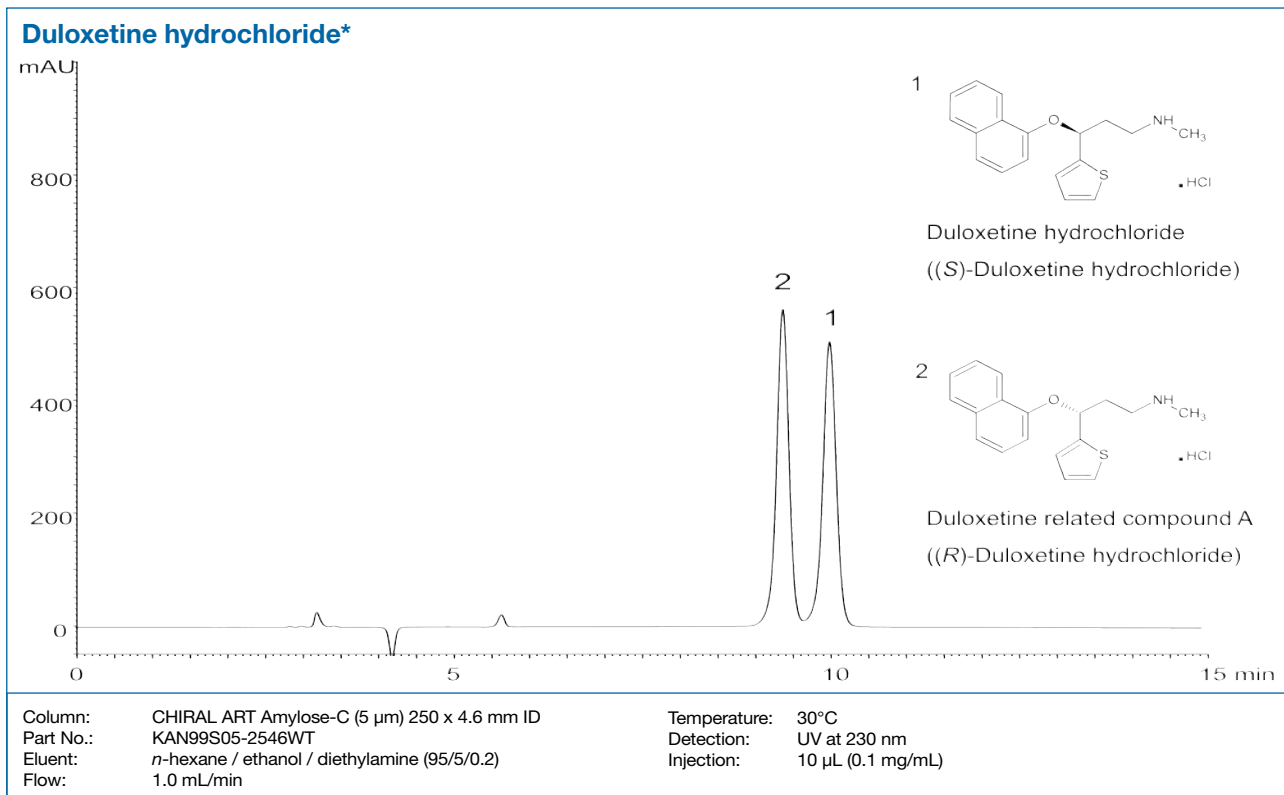

Coated Polysaccharides

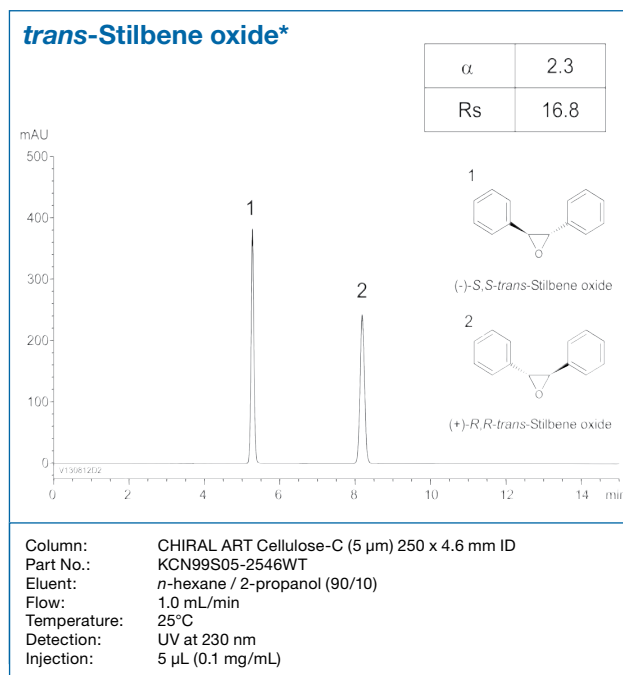
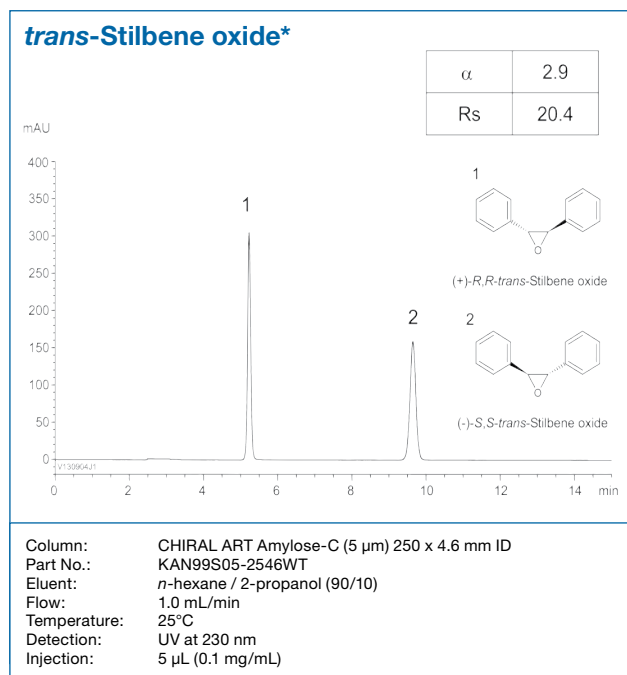
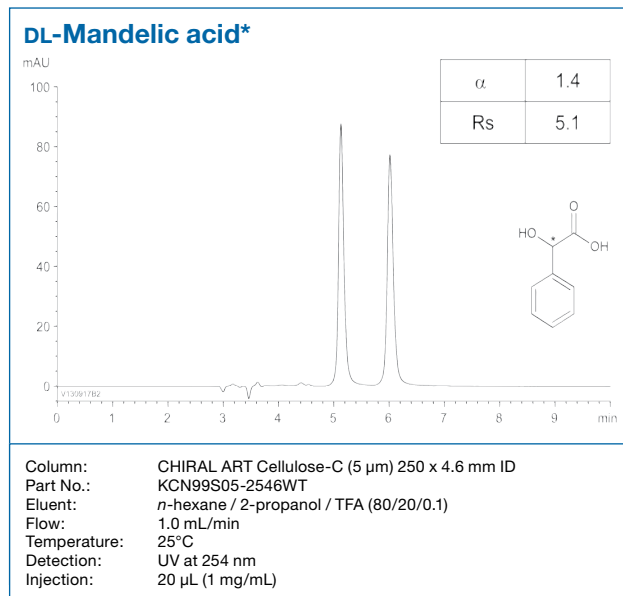
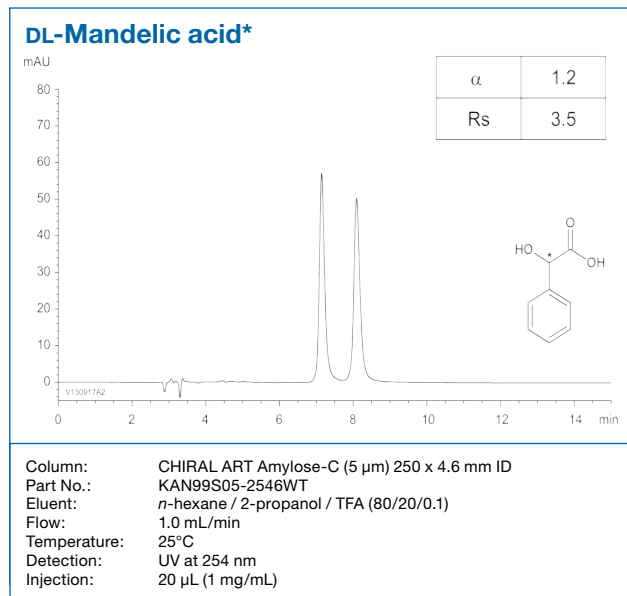

Coated Polysaccharides

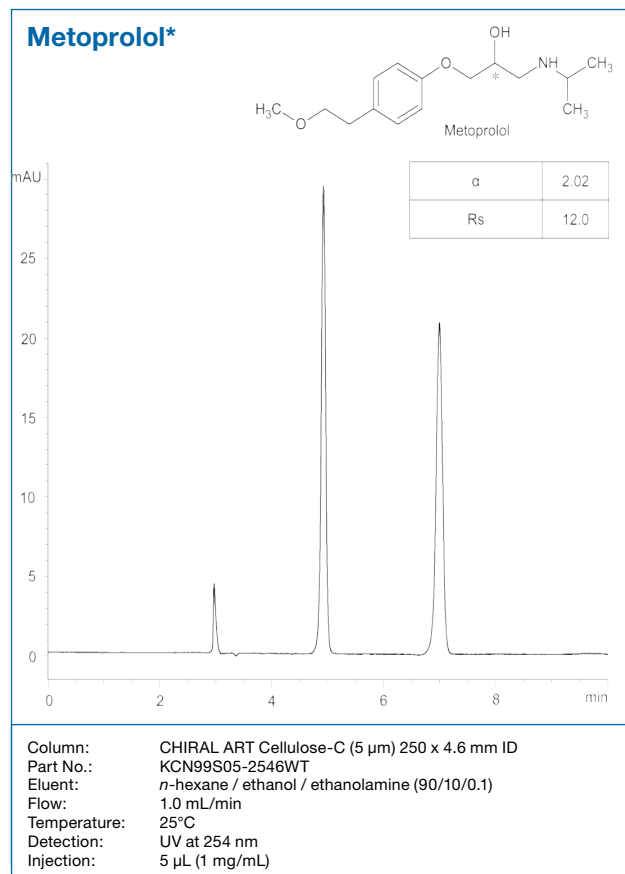
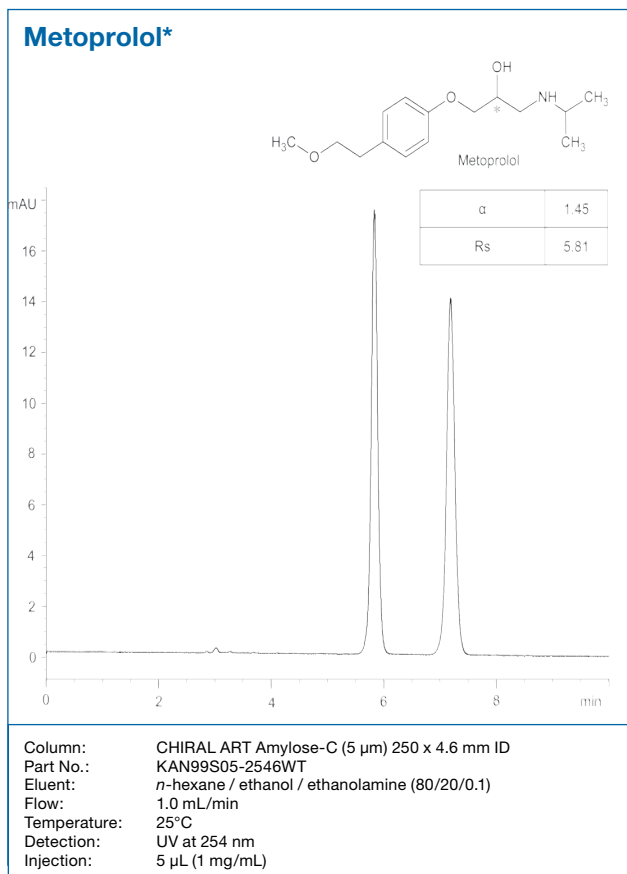
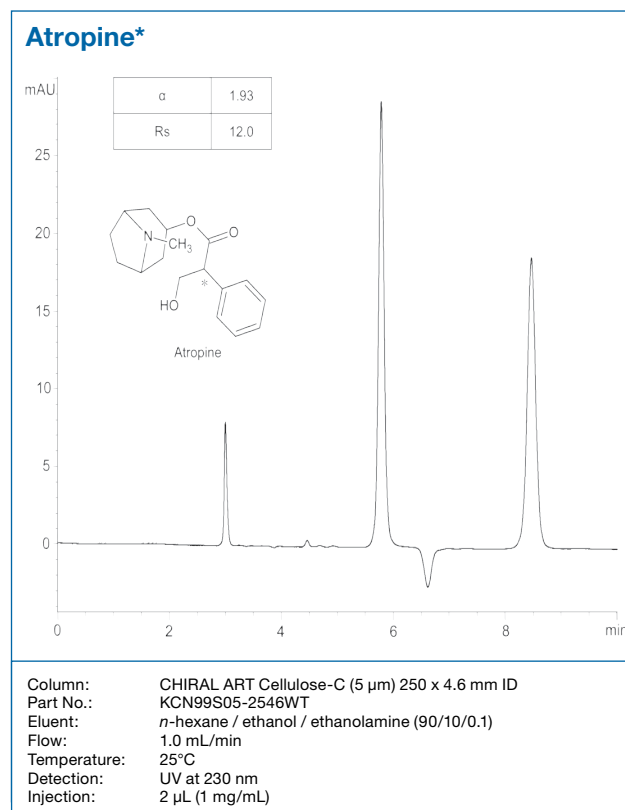
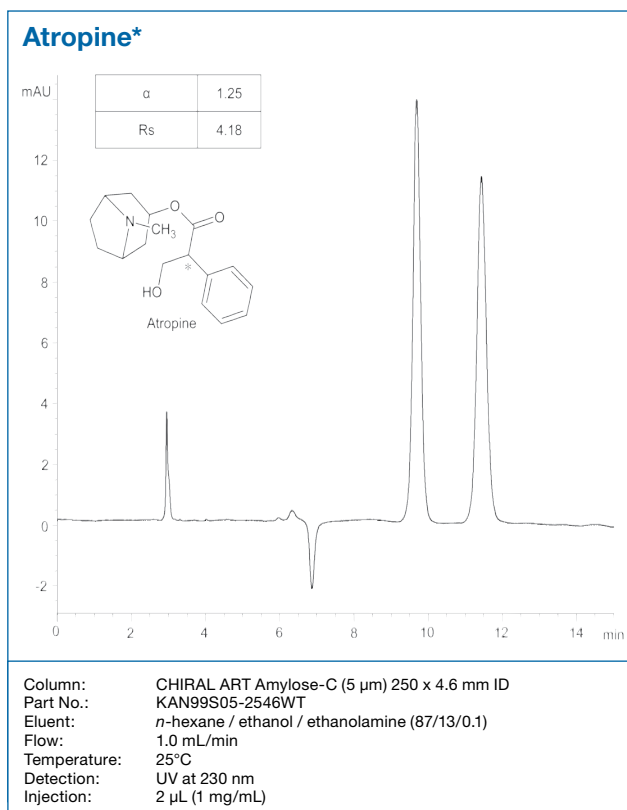

Coated Polysaccharides

Valsartan* (The United States Pharmacopeia)

Test solution*
(1.0 mg/mL Valsartan)

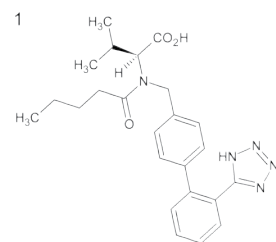
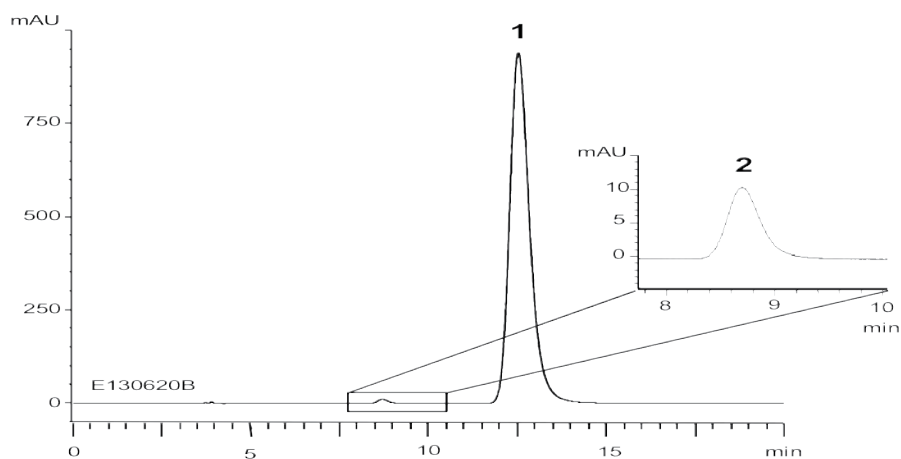

Valsartan

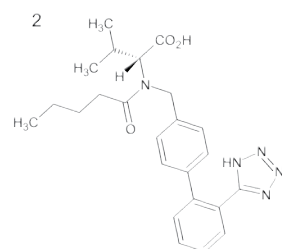

Valsartan enantiomer
(Valsartan related compound A)

* Test solution was prepared from Valsartan supplied as a reagent for laboratory use.

Column: CHIRAL ART Cellulose-C (5 μ m) 250 x 4.6 mm ID
Part No.: KCN99S05-2546WT
Eluent: *n*-hexane / 2-propanol / trifluoroacetic acid (85/15/0.1)
Flow: 0.8 mL/min

Temperature: 25°C
Detection: UV at 230 nm
Injection: 10 μ L
(The United States Pharmacopeia 34th, Related compounds)

Sertraline hydrochloride* (The European Pharmacopeia)

(A) Reference solution (a)*¹ (6.18 mg/mL Sertraline for system suitability CRS)

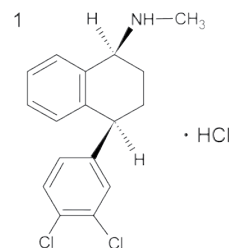
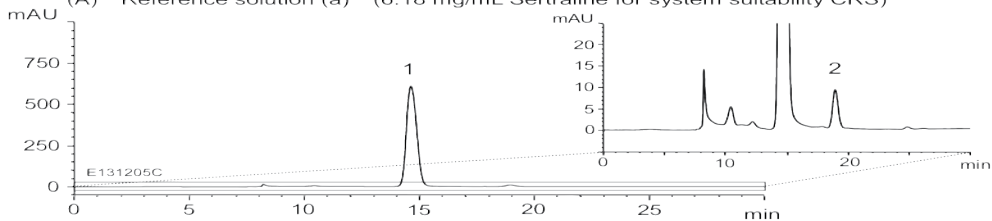

Sertraline hydrochloride

(B) Test solution*¹ (6.0 mg/mL Sertraline hydrochloride)

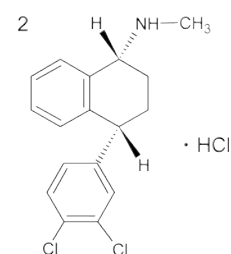
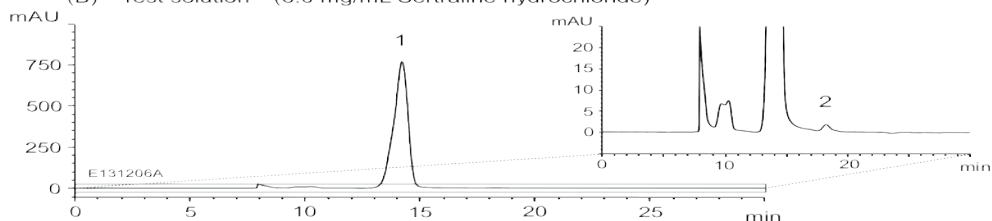

Sertraline hydrochloride
(enantiomer)

(C) Reference solution (b)*¹ (0.03 mg/mL Sertraline hydrochloride)

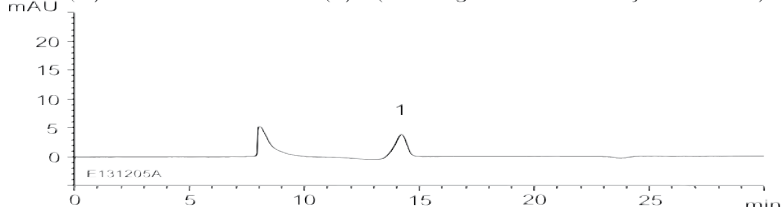

*¹ Test solution and Reference solution were prepared from Sertraline hydrochloride supplied as a reagent for laboratory use.

Column: CHIRAL ART Amylose-C (5 μ m) 250 x 4.6 mm ID
Part No.: KAN99S05-2546WT
Eluent: mixture*2 / *n*-hexane (70/30)
*2 *n*-hexane / 2-propanol / diethylamine (75/25/1)
Flow: 0.4 mL/min

Temperature: 25°C
Detection: UV at 275 nm
Injection: 20 μ L
(The draft for The European Pharmacopeia, Enantiomeric purity)

Coated Polysaccharides

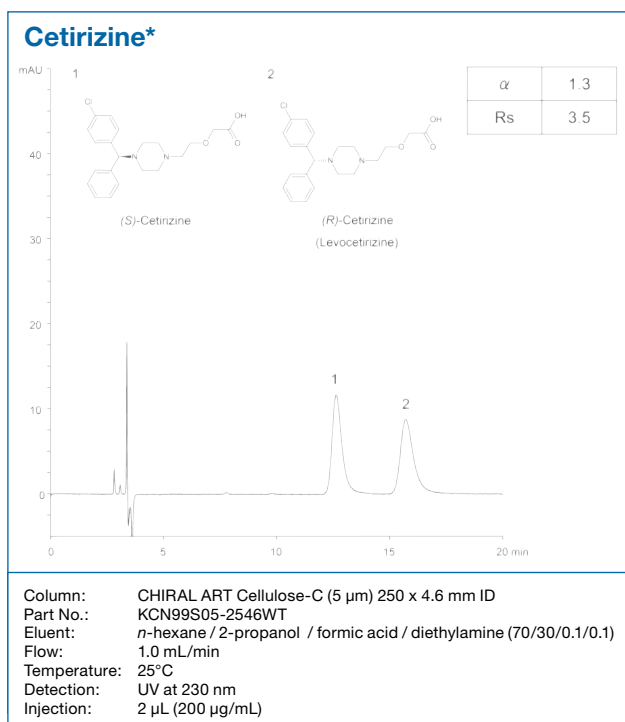
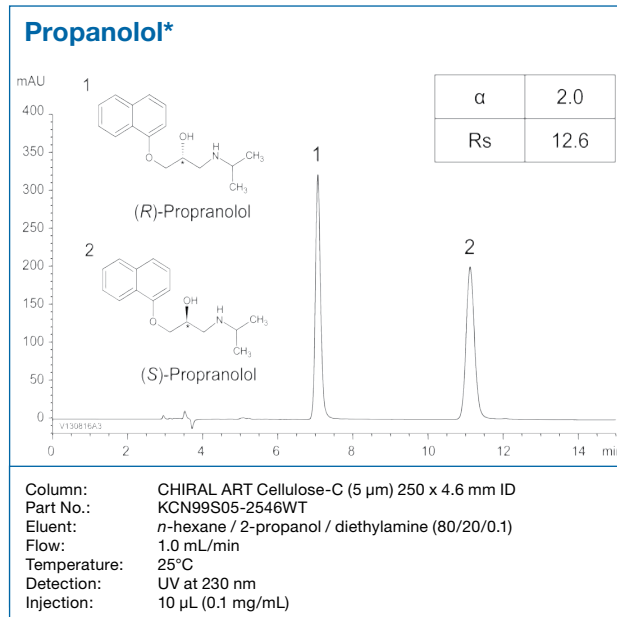
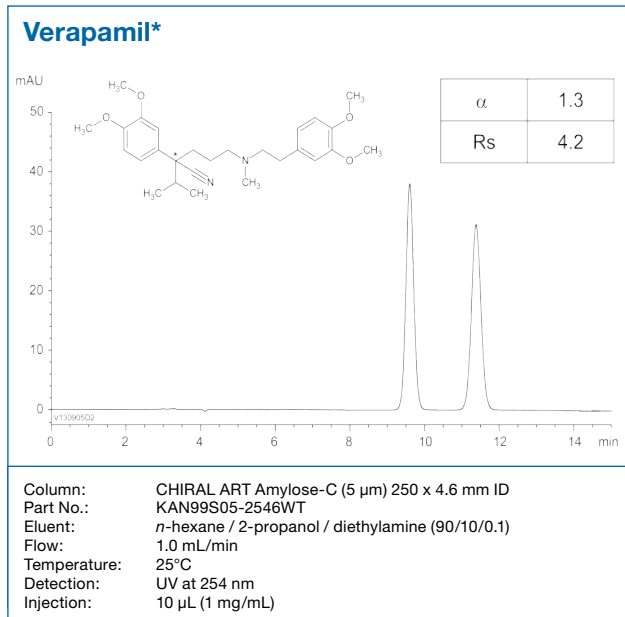

Column Care

The recommended pH range for using CHIRAL ART coated polysaccharide derivatives columns is 3.5-6.5. Store the column in *n*-hexane/2-propanol = 90/10. If columns are affected by undesired contaminants or clogged inlet frits which cause back pressure increases, flush the column with ethanol.

For detailed information please refer to the "Column Care and Use Instructions" which can be downloaded from www.ymc.de.

CHIRAL ART

Immobilised Polysaccharide Derivatives Series

- applicable for normal and reversed phase modes
- more flexibility due to wide range of usable solvents
- highly robust, also suitable for SFC/SMB
- remarkably reduced background signal
- HPLC columns and preparative grade bulk media with particle sizes of 3, 5, 10 and 20 μm available
- extremely attractive pricing

Introduction

CHIRAL ART polysaccharides derivatives are a series of chiral separation columns / packing materials with high stereo-selectivity. They are suitable for separations of a wide range of chiral compounds, cis-trans isomers and geometric isomers. The range of particle sizes and column dimensions available offer outstanding cost effectiveness for analytical to preparative separations.

Immobilised Type

CHIRAL ART immobilised polysaccharide derivatives can be used either in normal phase or in reversed phase modes. They are available in HPLC columns and in preparative grades, in large (multi kg) quantities.

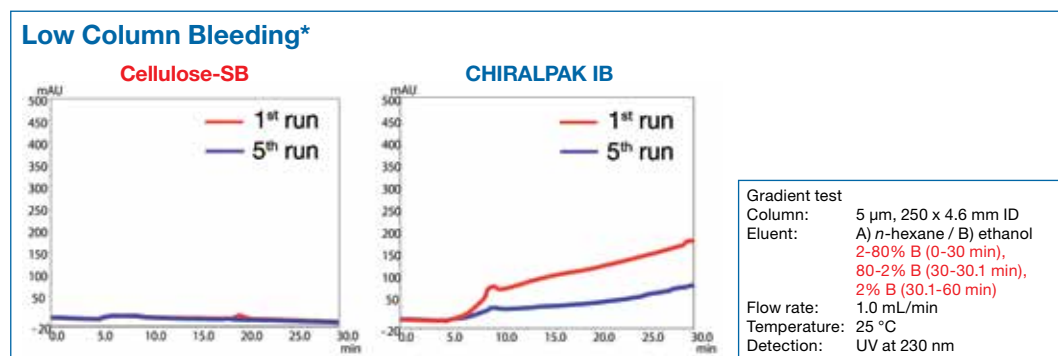
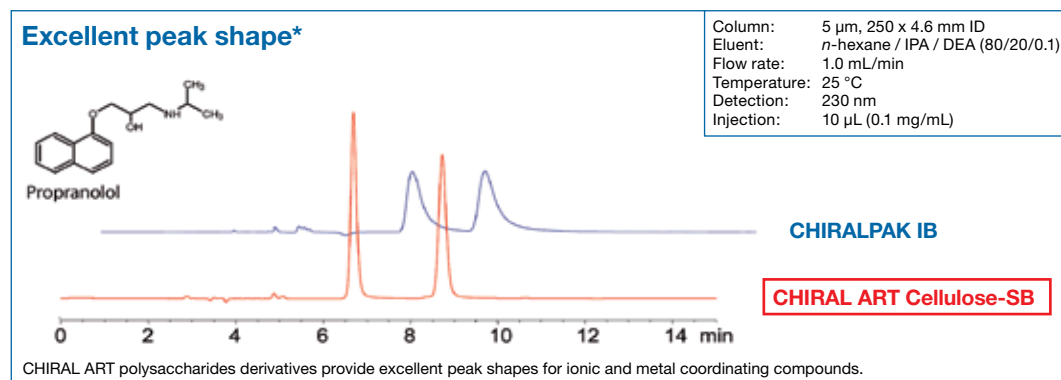

CHIRAL ART

Immobilised Polysaccharide Derivatives Series

Item	CHIRAL ART Amylose-SA	CHIRAL ART Cellulose-SB	CHIRAL ART Amylose-SE	CHIRAL ART Cellulose-SC
Particle size	3, 5, 10, 20 µm	3, 5, 10, 20 µm	5, 10, 20 µm	3, 5, 10, 20 µm
CHIRAL selector	Amylose tris (3,5-dimethylphenyl-carbamate)	Cellulose tris (3,5-dimethylphenyl-carbamate)	Amylose tris (3,5-dichlorophenyl-carbamate)	Cellulose tris (3,5-dichlorophenyl-carbamate)
Type	Immobilised type			
Separation mode	Normal Phase / Reversed Phase / SFC			
Shipping solvent	<i>n</i> -hexane / 2-propanol (90/10)			
Usable pH-range	2.0 - 9.0			
Pressure limit	30 MPa (4350 psi)			
Recommended flow rate	4.6 mm ID: 0.5 - 1.0 mL/min (Max. flow rate: 3.0 mL/min) 10 mm ID: 2.5 - 5.0 mL/min (Max. flow rate: 15 mL/min)			



Product Line-up

Product name	Particle size [µm]	CHIRAL selector	Type	Competitive product
CHIRAL ART Amylose-SA	3	Amylose tris (3,5-dimethylphenylcarbamate)	Immobilised	CHIRALPAK® IA, IA-3
CHIRAL ART Cellulose-SB	5	Cellulose tris (3,5-dimethylphenylcarbamate)		CHIRALPAK® IB, IB-3
CHIRAL ART Amylose-SE	10	Amylose tris (3,5-dichlorophenylcarbamate)		CHIRALPAK® IE, IE-3
CHIRAL ART Cellulose-SC	20	Cellulose tris (3,5-dichlorophenylcarbamate)		CHIRALPAK® IC, IC-3

Launch of CHIRAL ART Amylose-SE scheduled for 2016.

Immobilised Polysaccharides

Wide usable pH range*

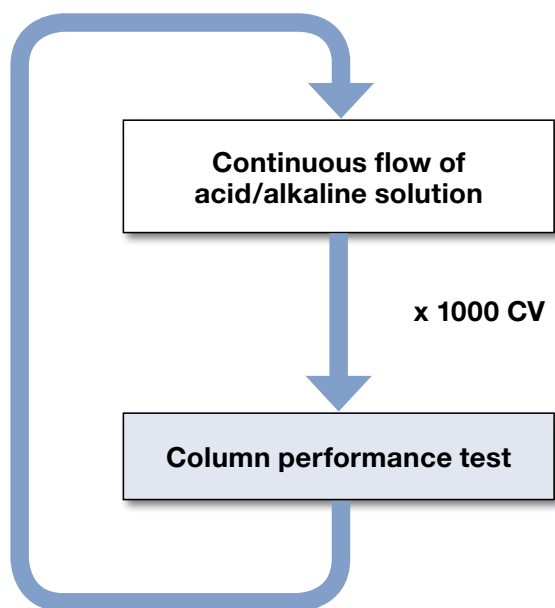

Continuous flow of acid/alkaline solution

Column: CHIRAL ART Cellulose-SB
5 μ m, 50 x 4.6 mm ID
Eluent: buffer/methanol (90/10)
Flow rate: 1.0 mL/min

Acidic condition

Buffer: 0.1% H₃PO₄ (pH 2)
Temperature: 40 °C

Basic condition

Buffer: 20 mM NH₄HCO₃-DEA (pH 9)
Temperature: 25 °C

Column performance test

Column: CHIRAL ART Cellulose-SB
5 μ m, 50 x 4.6 mm ID
Eluent: acetonitrile/water (30/70)
Flow rate: 1.0 mL/min
Temperature: 25 °C
Detection: UV at 254 nm
Sample: Benzoin

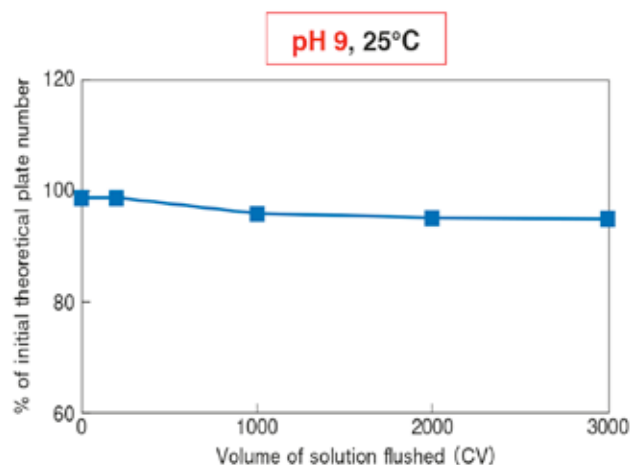
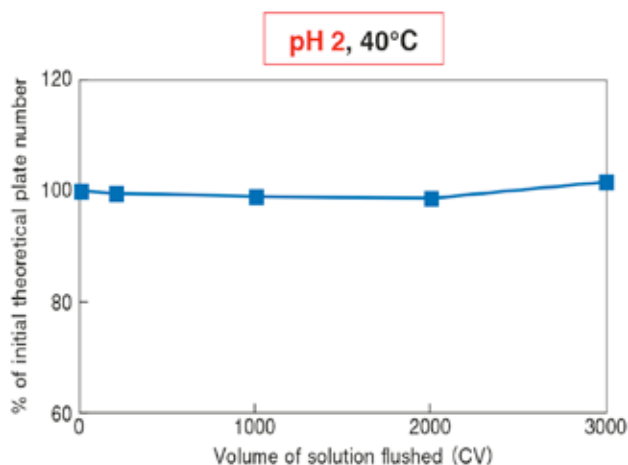

Immobilised Polysaccharides

High stability against various solvents*

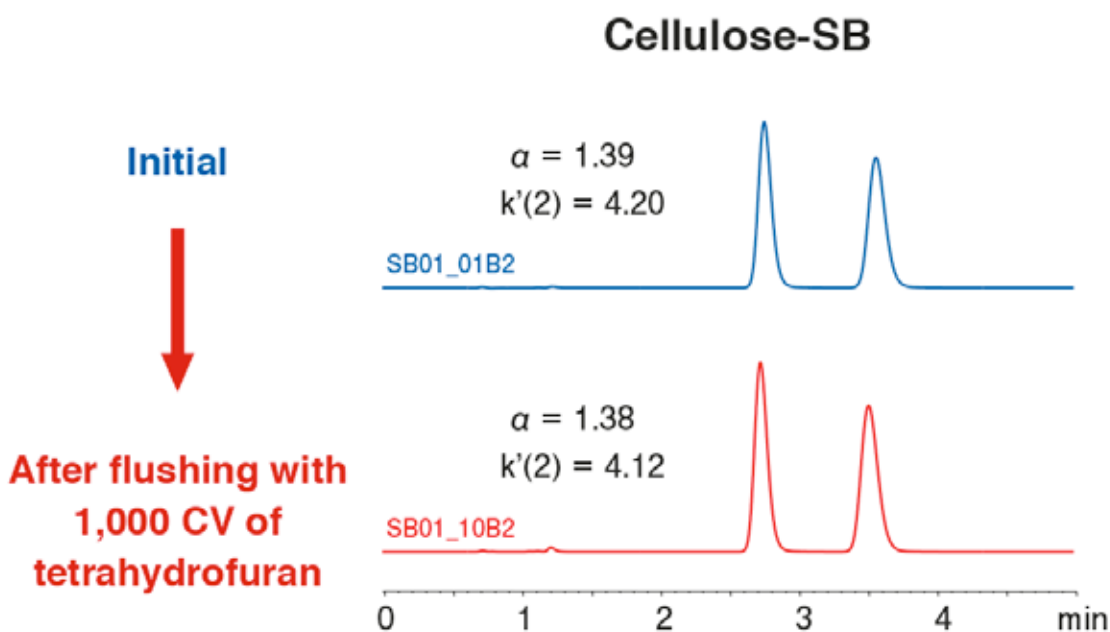
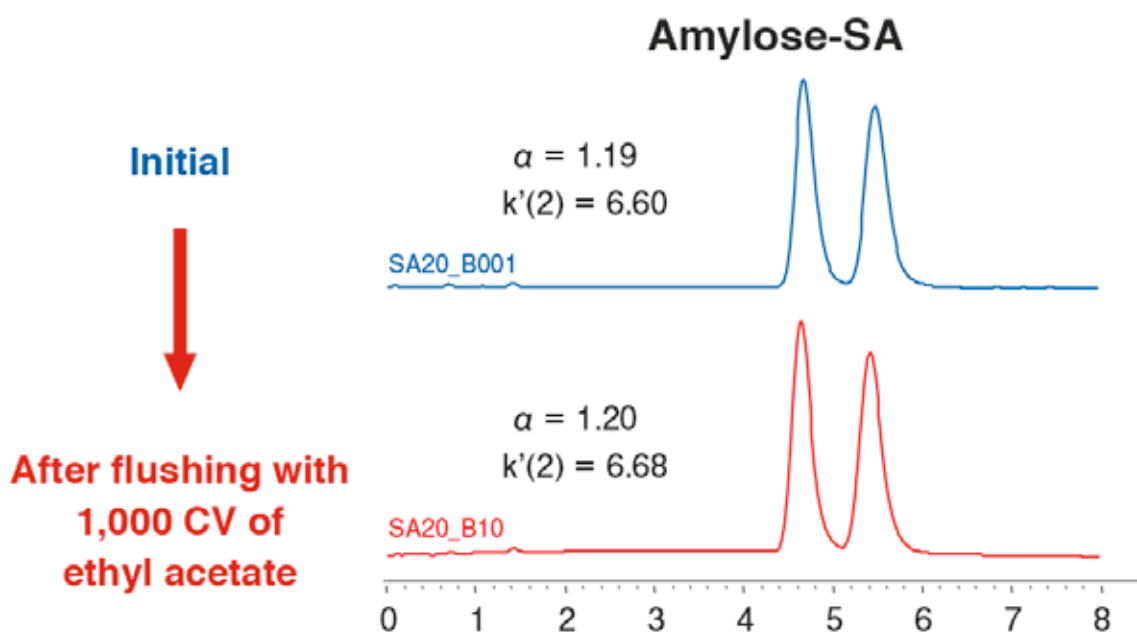

Column: 5 μ m, 50 x 4.6 mm ID
Eluent: *n*-hexane / 2-propanol (95/5)
Flow rate: 1.0 mL/min
Temperature: 25°C
Sample: Benzoin

Immobilised Polysaccharides

Applications

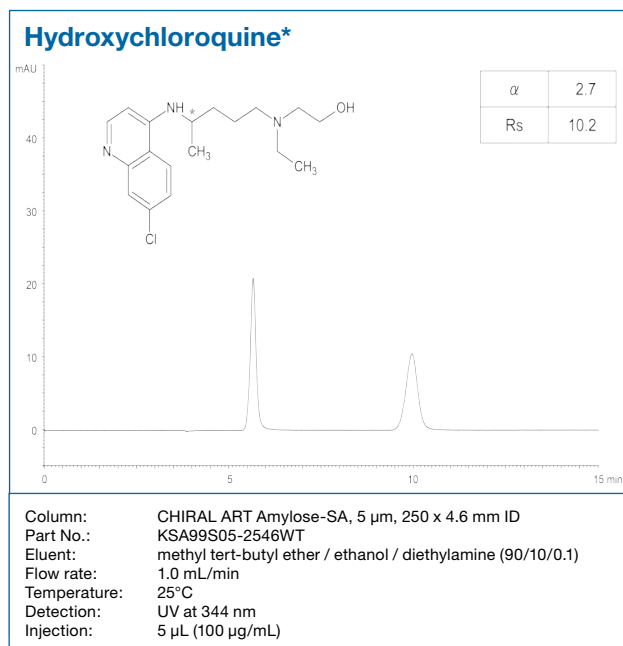
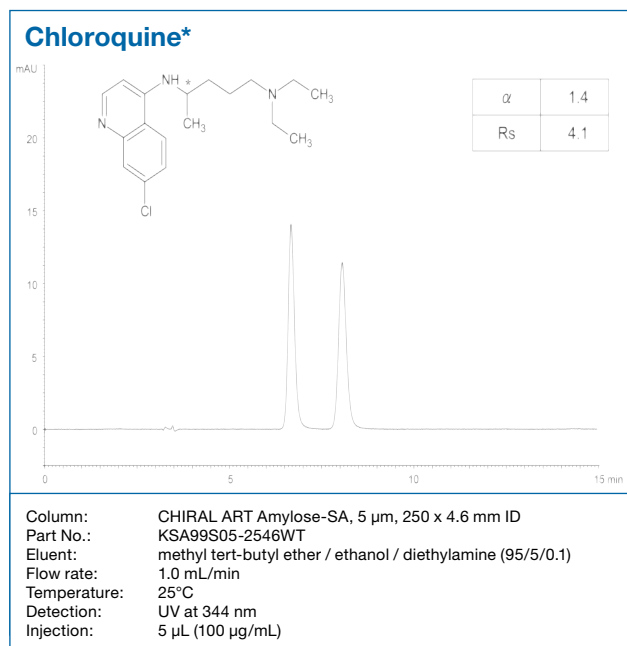
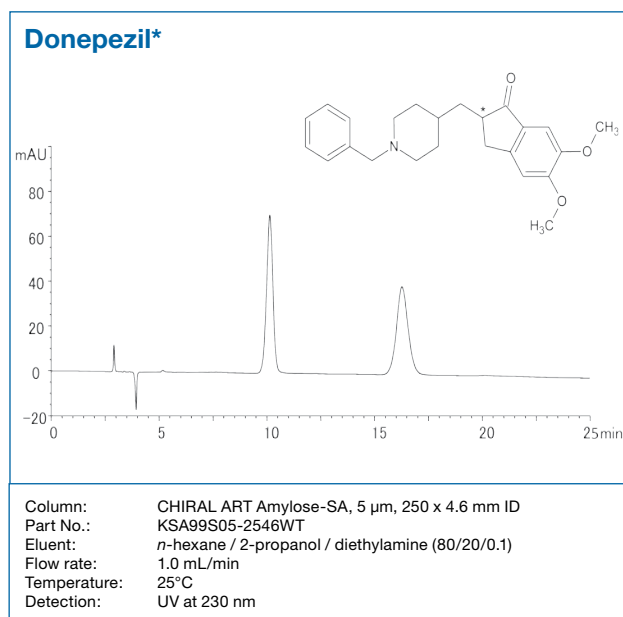
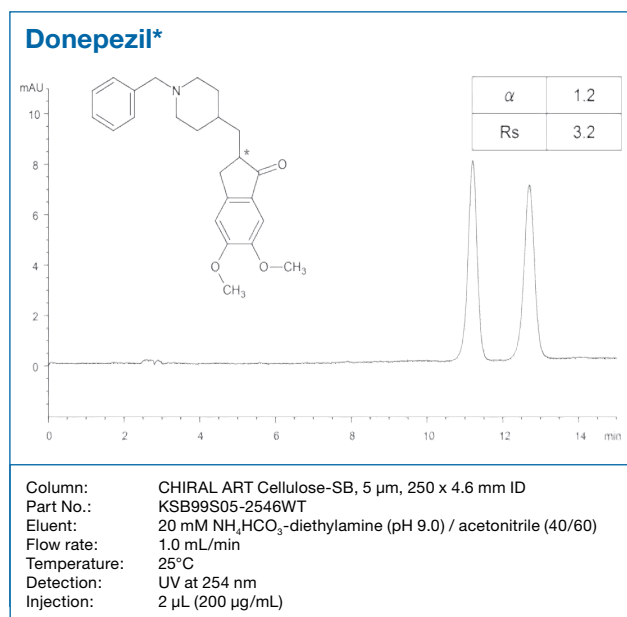

Immobilised Polysaccharides

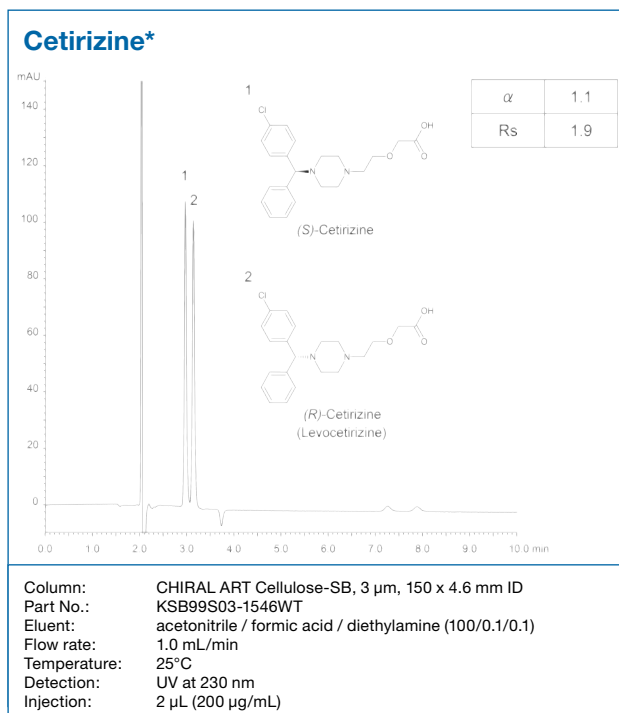
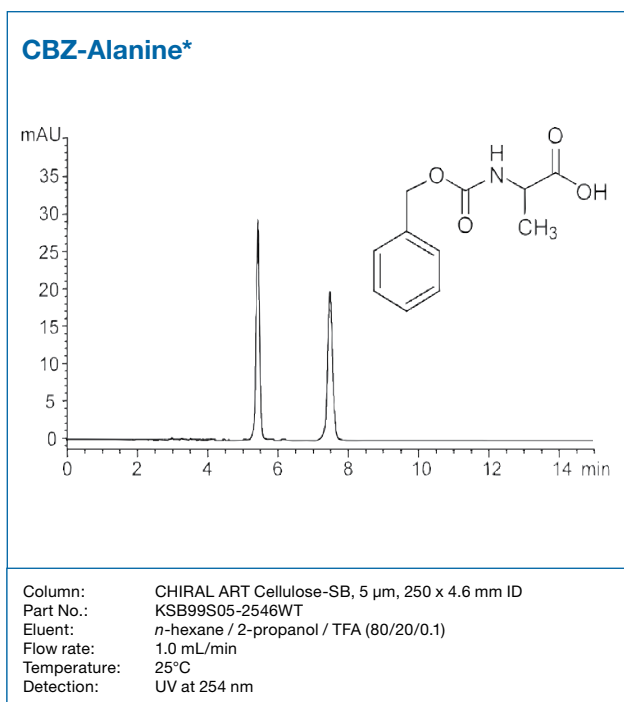
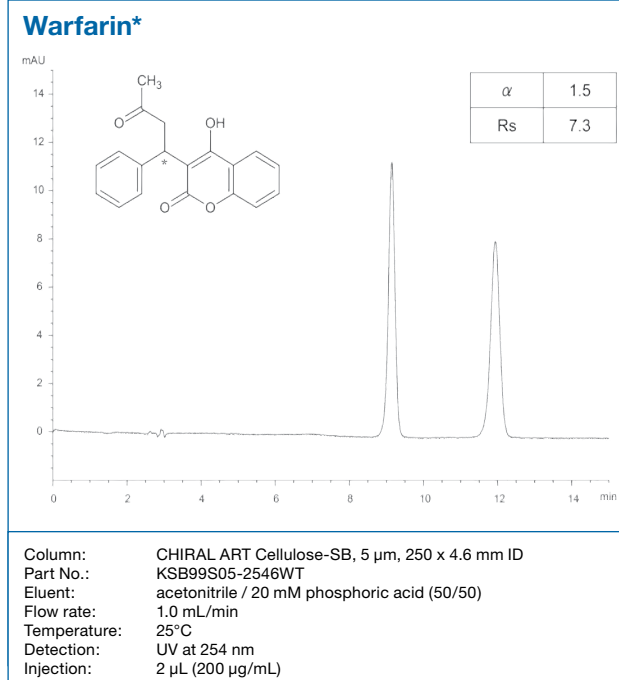
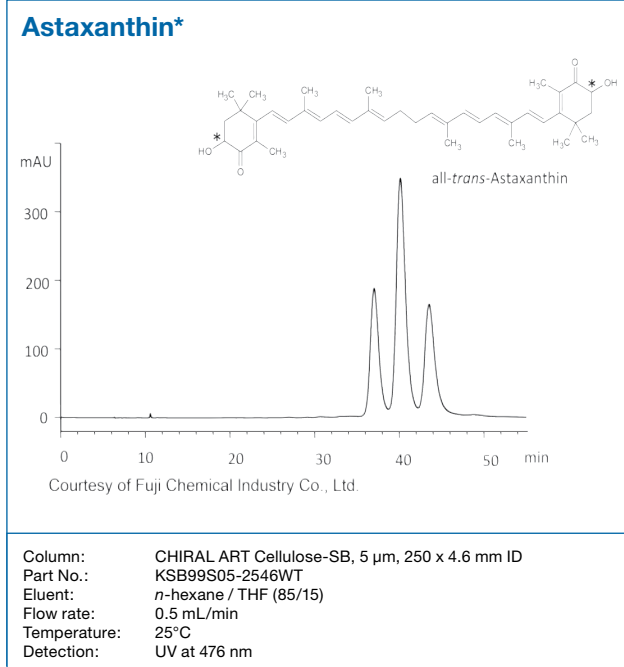

Immobilised Polysaccharides

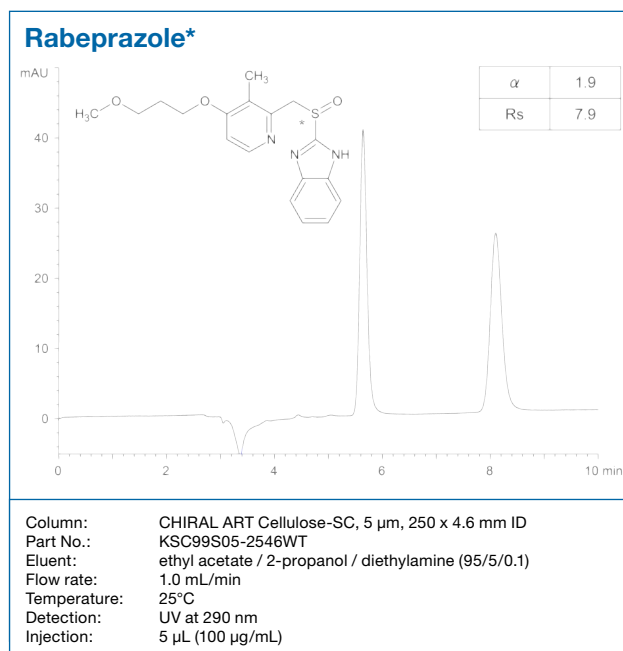
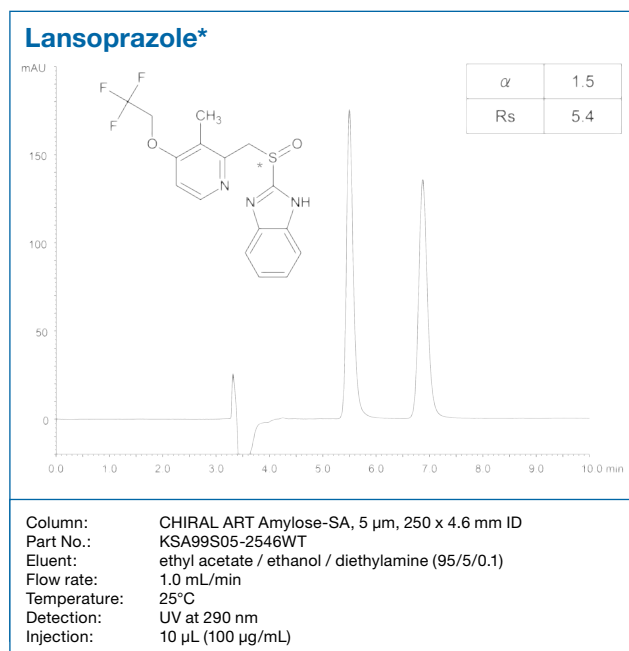
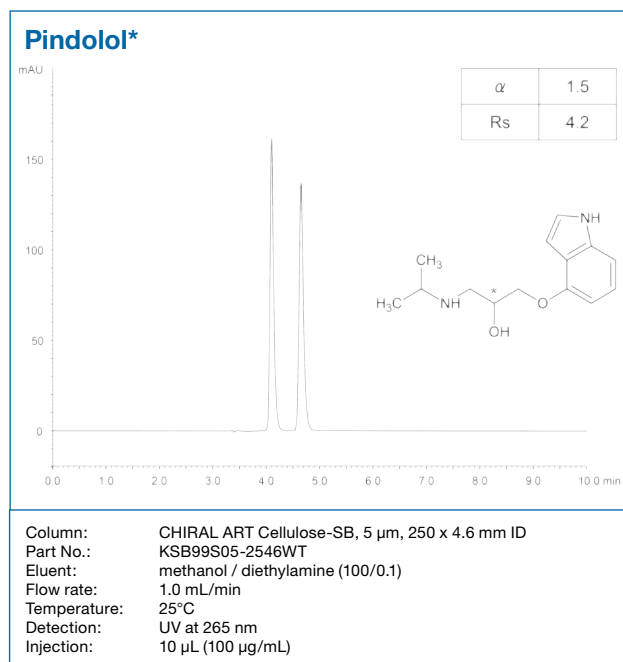
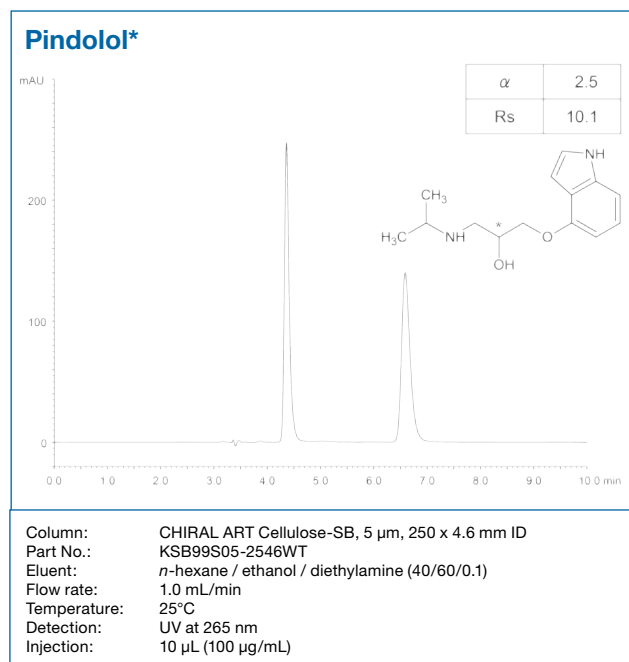

Immobilised Polysaccharides

Ofloxacin (Levofloxacin)*

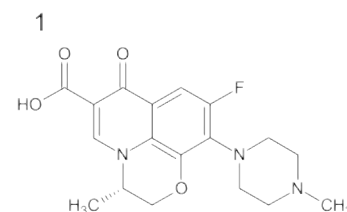
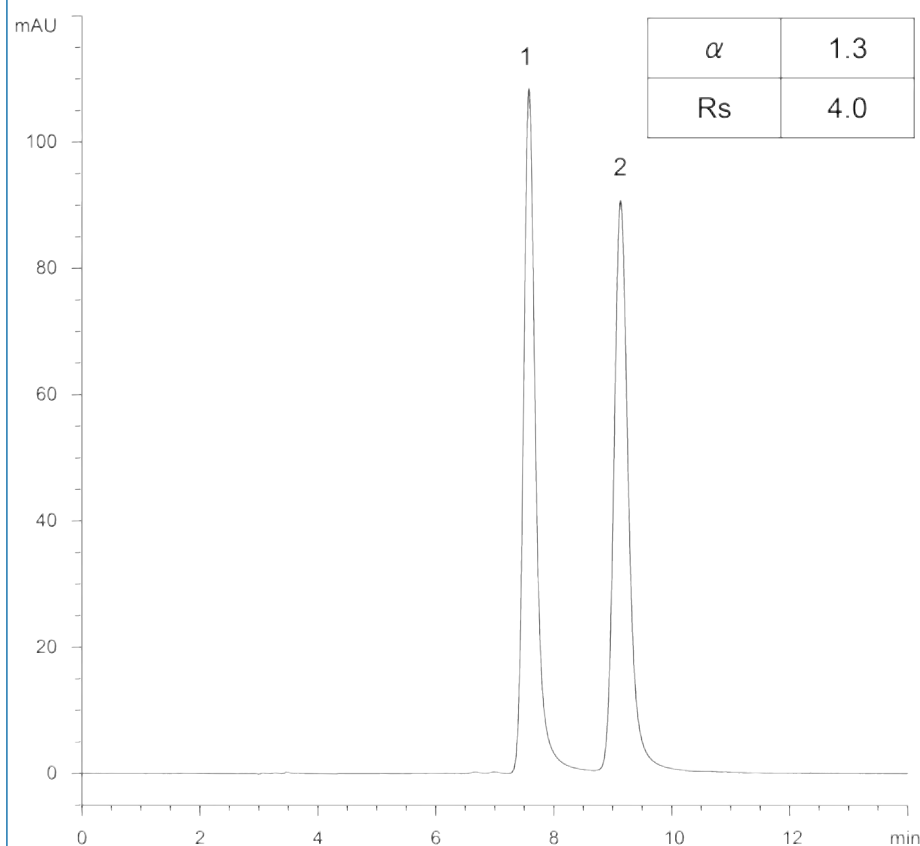

(S)-(-)-Ofloxacin
(Levofloxacin)

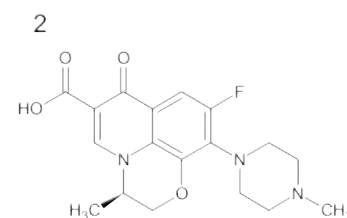

(R)-(+)-Ofloxacin

Column: CHIRAL ART Cellulose-SC, 5 μ m, 250 x 4.6 mm ID
 Part No.: KSC99S05-2546WT
 Eluent: tert-butyl methyl ether / ethanol / acetic acid / ethylenediamine (50/50/0.1/0.1)
 Flow rate: 1.0 mL/min
 Temperature: 40°C
 Detection: UV at 300 nm

Column Care

The recommended pH range for using CHIRAL ART immobilised polysaccharide derivatives columns is 2.0-9.0. Remove acid and buffer salts before storage. Store the column in *n*-hexane/2-propanol = 90/10 (NP) or methanol/water = 50/50 (RP). If columns are affected by undesired contaminants or clogged inlet frits which cause back pressure increases, flush the column (in the reversed direction) with ethanol.

For detailed information please refer to the "Column Care and Use Instructions" which can be downloaded from www.ymc.de.

YMC CHIRAL NEA(R)(S)

- normal and reversed phase mode
- reversal of elution order
- nonpolar to medium polar compounds
- available in bulk quantities



YMC CHIRAL NEA(R)(S)	Specification
Particle Size / μm	5
Pore Size / nm	30
Surface area / m^2g^{-1}	proprietary
Carbon content / %	proprietary
Recommended pH range	2.0 - 6.5 (reversed phase)

Properties

Although separation modes are chosen according to the purpose of separation, it is recommended to use one column dedicated for one separation mode in order to maximise the lifetime of the column.

In normal phase mode YMC CHIRAL NEA allows the separation of a wide range of non-polar to moderately polar compounds.

The separation mechanisms involve a combination of:

- π - π interactions
- hydrogen bonding
- dipole interactions
- steric effects.

For a successful separation at least three points of interaction between the CSP and the target compound must exist. Occasionally, for analytical separations, there may be a need to derivatise the sample with, for example p-donating groups such as dinitrobenzoyl, dinitrophenylurea or dinitrophenylcarbamate groups. In some cases, the increase in detectability can offset the disadvantages of derivatisation

Chiral Separation Mechanism

3 points of interaction: separation

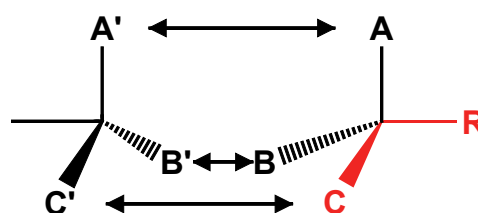

2 points of interaction: no separation

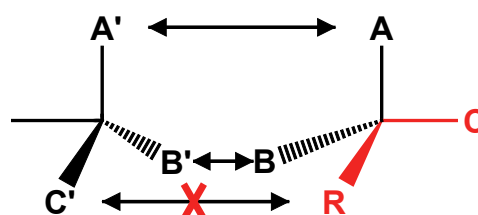

YMC CHIRAL NEA(R)(S)

Applications used in normal phase mode

1,1'-Bi-2-Naphthol*

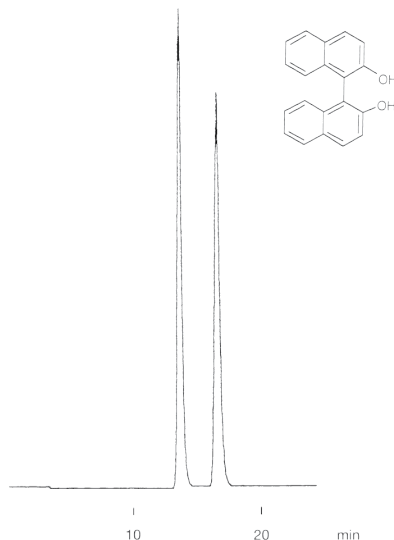

Column: YMC CHIRAL NEA (R) 250 x 4.6 mm ID
 Part No.: CR30S05-2546WT
 Eluent: *n*-hexane / dichloromethane / ethanol (70/30/2)
 Flow rate: 1.0 mL/min
 Temperature: 25°C
 Detection: UV at 254 nm

2,2,2-Trifluoro-1-(9-anthryl) ethanol*

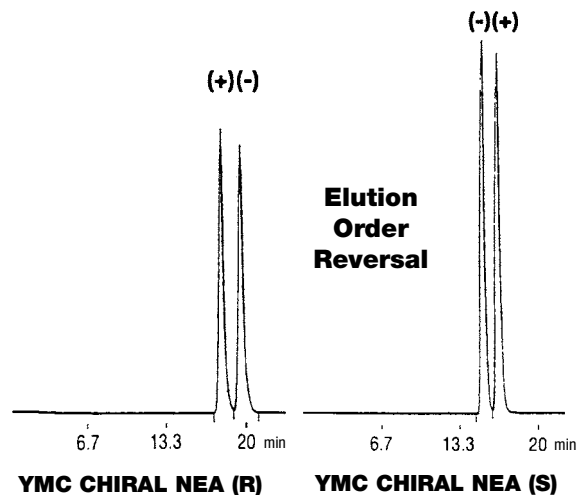

Column: YMC CHIRAL NEA (R) and YMC CHIRAL NEA (S) 250 x 4.6 mm ID
 Part No.: CR30S05-2546WT and CS30S05-2546WT
 Eluent: *n*-hexane / dichloromethane / ethanol (70/30/1)
 Flow rate: 0.5 mL/min
 Temperature: 25°C
 Detection: UV at 254 nm

Hexobarbital*

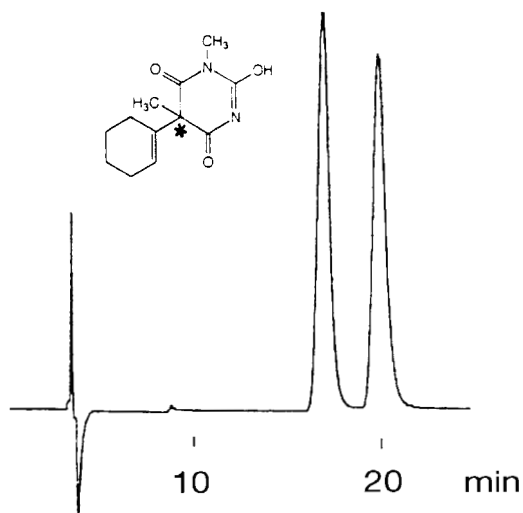

Column: YMC CHIRAL NEA (R) 250 x 4.6 mm ID
 Part No.: CR30S05-2546WT
 Eluent: *n*-hexane / CH₂Cl₂ / ethanol (90/10/2)
 Flow rate: 1.0 mL/min
 Temperature: ambient
 Detection: UV at 220 nm

1-Phenylethanol*

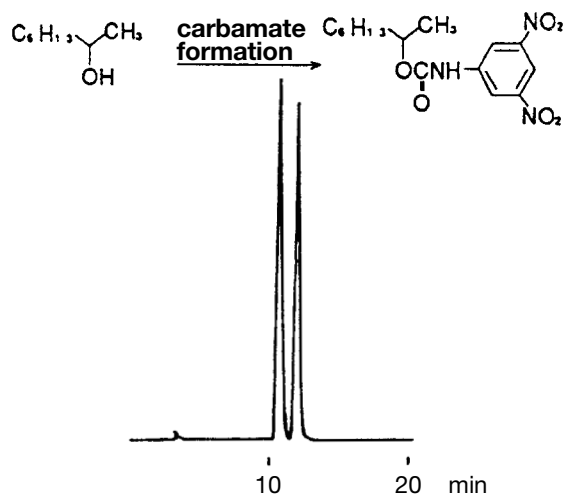

Column: YMC CHIRAL NEA (R) 250 x 4.6 mm ID
 Part No.: CR30S05-2546WT
 Eluent: *n*-hexane / CH₂Cl₂ / ethanol (90/10/5)
 Flow rate: 1.0 mL/min
 Temperature: 35°C
 Detection: UV at 254 nm

YMC CHIRAL NEA(R)(S)

Applications used in reversed phase mode

1,1'-Bi-2-Naphthol*

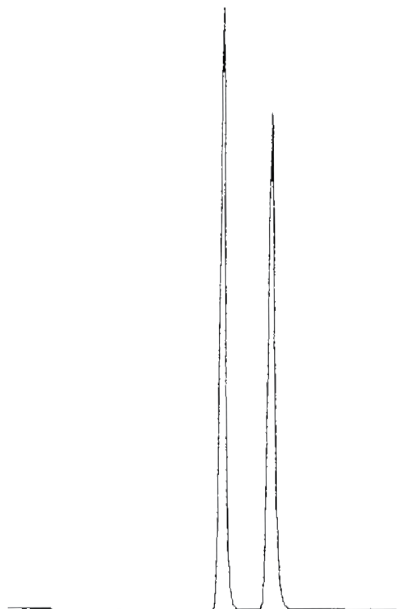

Column: YMC CHIRAL NEA (R) 250 x 4.6 mm ID
 Part No.: NR30S05-2546WT
 Eluent: acetonitrile / water (50/50)
 Flow: 1.0 mL/min
 Pressure: 80 bar
 Detection: UV at 235 nm
 Injection: 1.0 μ L (2.8 mg/mL)
 Temperature: ambient

Propranolol · HCl*

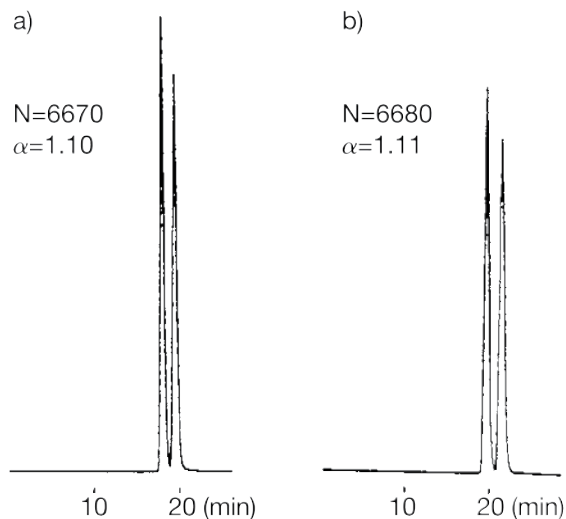

a)
 Column: YMC CHIRAL NEA (R) 250 x 4.6 mm ID
 Part No.: NR30S05-2546WT
 Eluent: acetonitrile / 0.5M NaClO₄ (40/60)
 Flow: 1.0 mL/min
 Temperature: ambient
 Time: 100 hours

b)
 Eluent: acetonitrile / 0.5M NaClO₄ (40/60)
 Flow: 1.0 mL/min
 Temperature: ambient
 Detection: UV at 254 nm

Hexobarbital*

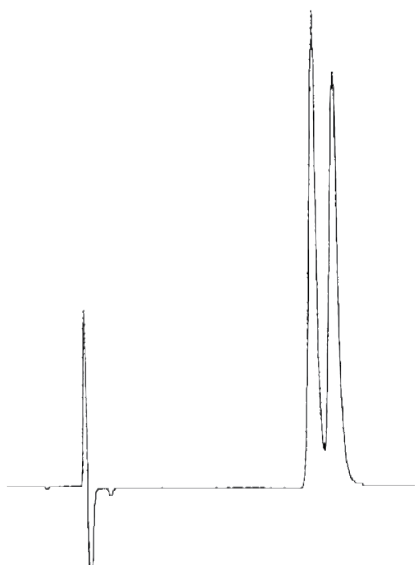

Column: YMC CHIRAL NEA (R) 250 x 4.6 mm ID
 Part No.: NR30S05-2546WT
 Eluent: acetonitrile / water (30/70)
 Flow: 0.7 mL/min
 Detection: UV at 210 nm
 Injection: 1.0 μ L (1.2 mg/mL)
 Temperature: ambient

CBZ-Phenylalanine (Z-Phe-OH)*

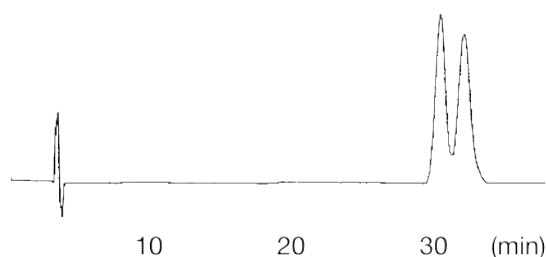

Column: YMC CHIRAL NEA (R) 250 x 4.6 mm ID
 Part No.: NR30S05-2546WT
 Eluent: 0.5M NaClO₄-HClO₄ (pH 2.0) / acetonitrile (70/30)
 Flow: 1.0 mL/min
 Detection: UV at 254 nm
 Injection: 10 μ L (1.5 mg/mL)
 Temperature: ambient

YMC CHIRAL NEA(R)(S)

2,2,2-Trifluoro-1-(9-anthryl)-ethanol*

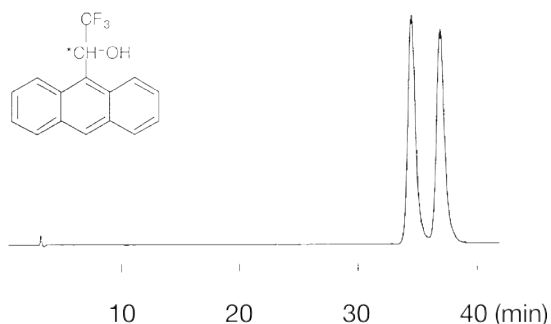

Column: YMC CHIRAL NEA (R) 250 x 4.6 mm ID
 Part No.: NR30S05-2546WT
 Eluent: acetonitrile / water (40/60)
 Flow: 1.0 mL/min
 Detection: UV at 254 nm
 Injection: 1.0 μ L (0.14 mg/mL)
 Temperature: ambient

Ketamin · HCl*

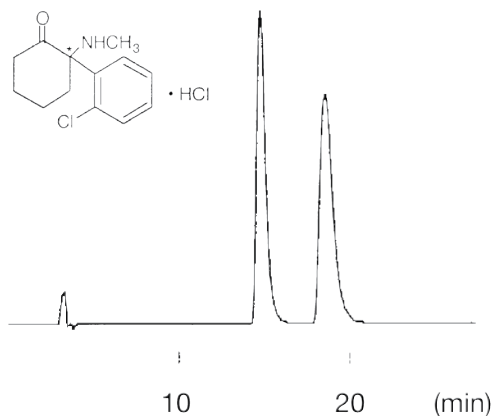

Column: YMC CHIRAL NEA (R) 250 x 4.6 mm ID
 Part No.: NR30S05-2546WT
 Eluent: acetonitrile / 0.5M NaClO₄ (40/60)
 Flow: 1.0 mL/min
 Detection: UV at 268 nm
 Injection: 10 μ L (1.4 mg/mL)
 Temperature: ambient

Column Care

The recommended pH range for using YMC CHIRAL NEA(R)(S) columns is 2.0-6.5. Remove acid and buffer salts before storage. Store the column in methanol/water = 50/50. If columns are affected by undesired contaminants or clogged inlet frits which cause back pressure increases, flush the column with THF in the opposite flow direction.

For detailed information please refer to the "Column Care and Use Instructions" which can be downloaded from www.ymc.de.

YMC CHIRAL CD BR

- reversed phase
- polar pharmaceuticals
- positional isomers
- water-soluble compounds



YMC CHIRAL CD BR	Specification
Particle Size / μm	5
Pore Size / nm	12
Surface area / m^2g^{-1}	proprietary
Carbon content / %	proprietary
Recommended pH range	3.5 - 6.5

Properties

YMC CHIRAL CD BR columns offer an alternative approach to enantioseparation. Covalent bonding of a bromide derivative of a cyclodextrin to YMC silica provides a novel CSP. The bromide derivative, in which the primary hydroxyl groups at carbon 6 are substituted for bromine, provides a different chiral selectivity to the 'normal' cyclodextrins. These cyclodextrin bromide derivatives are used in reversed phase mode to separate a wide range of polar, water-soluble compounds. In addition they will separate, under similar conditions, positional isomers of substituted aromatic compounds.

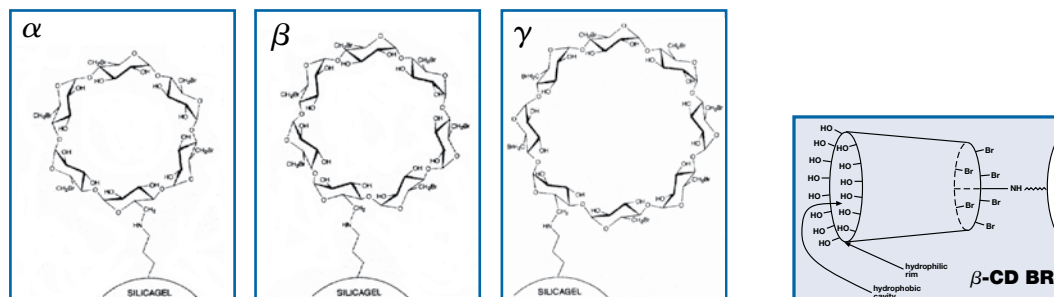

YMC CHIRAL CD BR

Applications

Hexobarbital*

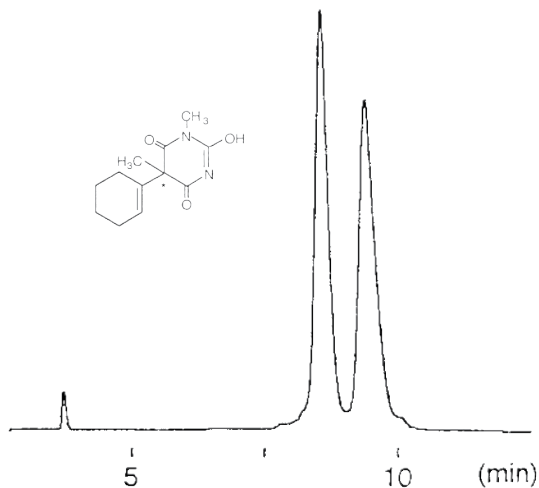

Column: YMC CHIRAL β -CD BR 250 x 4.6 mm ID
 Part No.: DB12S05-2546WT
 Eluent: 0.1M acetic acid-triethylamine in water (pH5.6) / methanol (30/70)
 Flow: 1.0 mL/min
 Temperature: 30°C
 Detection: UV at 254 nm
 Injection: 5 μ L (1 mg/mL)

Ketoprofen*

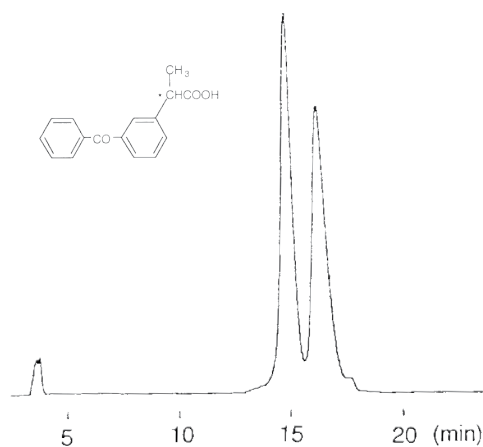

Column: YMC CHIRAL β -CD BR 250 x 4.6 mm ID
 Part No.: DB12S05-2546WT
 Eluent: 0.1M acetic acid-triethylamine in water (pH5.6) / methanol (30/70)
 Flow: 1.0 mL/min
 Temperature: 25°C
 Detection: UV at 254 nm
 Injection: 10 μ L (1 mg/mL)

Flurbiprofen*

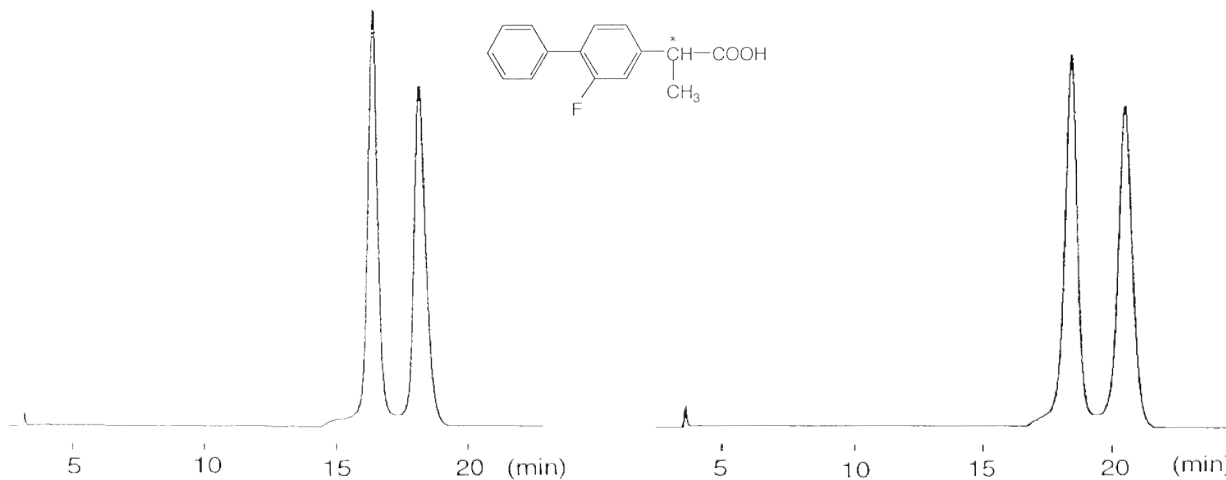

Column: YMC CHIRAL β -CD BR 250 x 4.6 mm ID
 Part No.: DB12S05-2546WT
 Eluent: 0.1M acetic acid-triethylamine in water (pH4.0) / acetonitrile (10/90)
 Flow: 1.0 mL/min
 Temperature: 25°C
 Detection: UV at 254 nm
 Injection: 2 μ L (1 mg/mL)

Column: YMC CHIRAL γ -CD BR 250 x 4.6 mm ID
 Part No.: DG12S05-2546WT
 Eluent: 0.1M acetic acid-triethylamine in water (pH4.0) / methanol (30/70)
 Flow: 1.0 mL/min
 Temperature: 25°C
 Detection: UV at 254 nm
 Injection: 2 μ L (1 mg/mL)

YMC CHIRAL CD BR

1-(1-naphthyl)-ethylalcohol*

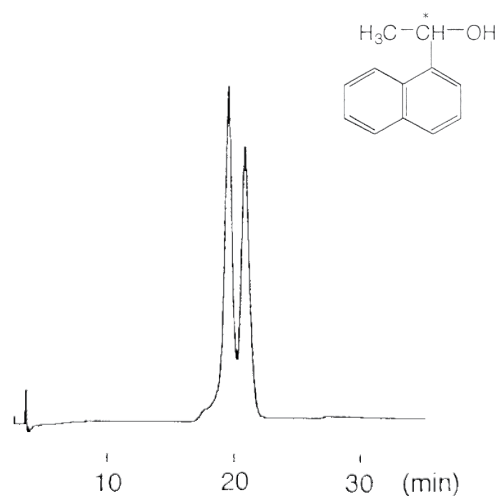

Column: YMC CHIRAL γ -CD BR 250 x 4.6 mm ID
 Part No.: DG12S05-2546WT
 Eluent: 0.1M AcOH_{aq}-TEA (Triethylamine)_{aq} (pH5.6) / methanol (90/10)
 Flow: 1.0 mL/min
 Temperature: 30°C
 Detection: UV at 254 nm
 Injection: 5 μ L (1 mg/mL)

Phenylethylalcohol*

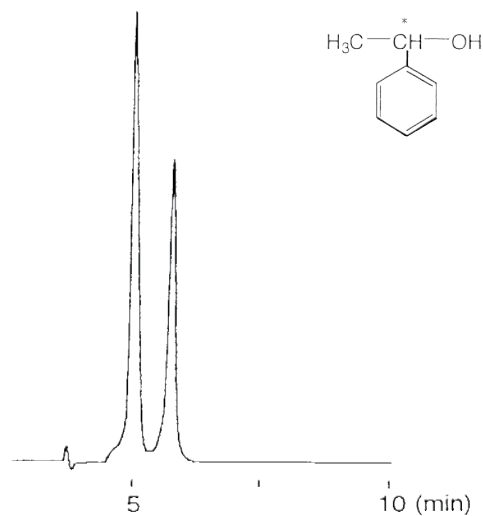

Column: YMC CHIRAL γ -CD BR 250 x 4.6 mm ID
 Part No.: DG12S05-2546WT
 Eluent: 0.1M AcOH_{aq}-TEA (Triethylamine)_{aq} (pH4.0) / methanol (90/10)
 Flow: 1.0 mL/min
 Temperature: 30°C
 Detection: UV at 254 nm
 Injection: 5 μ L (10 mg/mL)

Cresols*

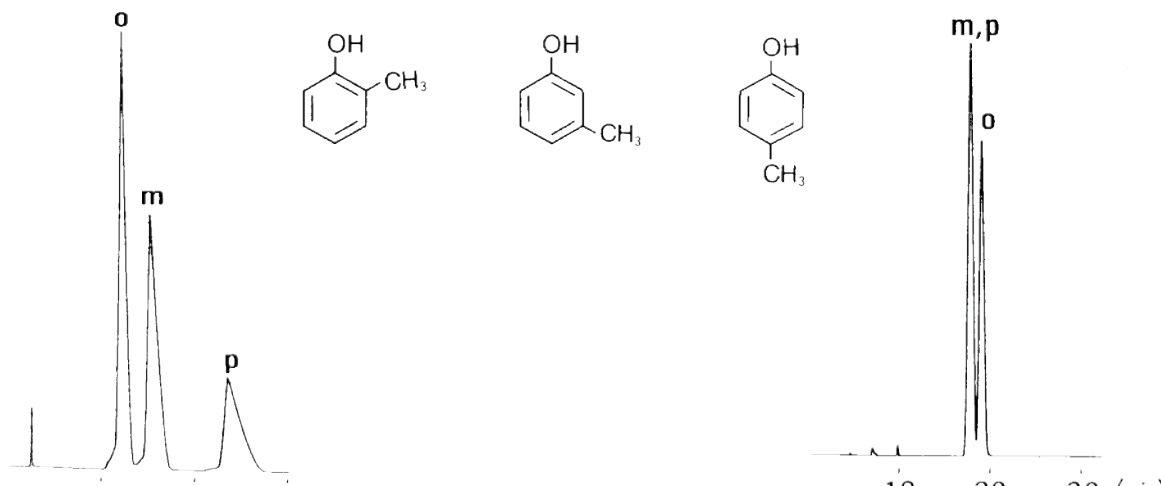

Column: YMC CHIRAL β -CD BR 250 x 4.6 mm ID
 Part No.: DB12S05-2546WT
 Eluent: methanol / water (20/80)
 Flow: 1.0 mL/min
 Temperature: ambient
 Detection: UV at 254 nm

Column: YMC Pack ODS-AM 250 x 4.6 mm ID
 Part No.: AM12S05-2546WT
 Eluent: methanol / water (40/60)
 Flow: 1.0 mL/min
 Temperature: ambient
 Detection: UV at 254 nm

YMC CHIRAL CD BR

Estradiols*

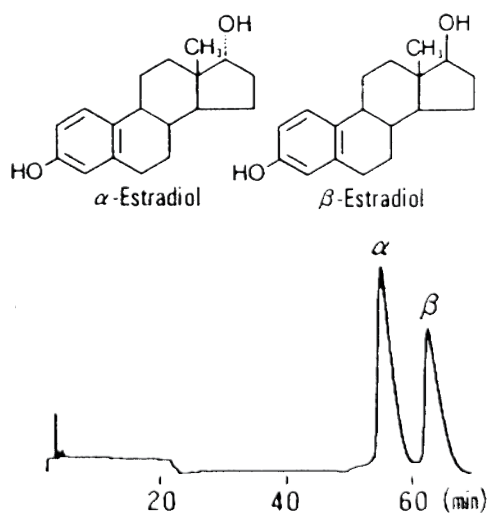

Column: YMC CHIRAL γ -CD BR 250 x 4.6 mm ID
 Part No.: DG12S05-2546WT
 Eluent: methanol / water (50/50)
 Flow: 1.0 mL/min
 Temperature: 30°C
 Detection: UV at 230 nm

Propranolol HCl*

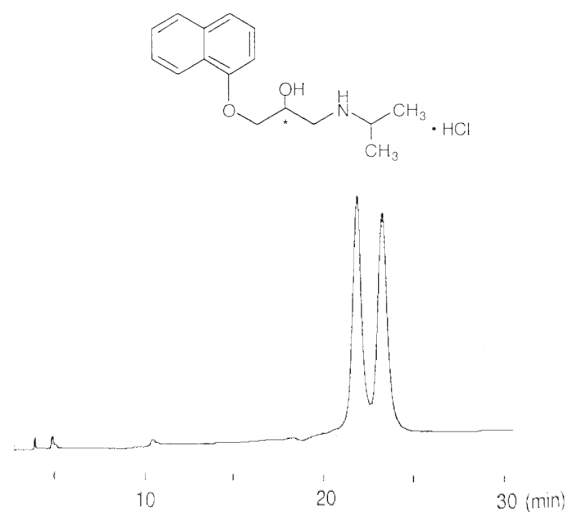

Column: YMC CHIRAL γ -CD BR 250 x 4.6 mm ID
 Part No.: DG12S05-2546WT
 Eluent: acetonitrile / methanol / acetic acid / triethylamine (99/1/0.3/0.25)
 Flow: 1.0 mL/min
 Temperature: 25°C
 Detection: UV at 254 nm
 Injection: 5 μ L (1 mg/mL)

Nitrophenols*

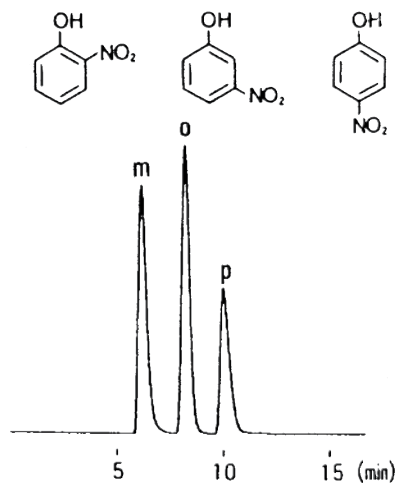

Column: YMC CHIRAL α -CD BR 250 x 4.6 mm ID
 Part No.: DA12S05-2546WT
 Eluent: 0.1M CH_3COOH - CH_3COONa (pH4.0) / methanol (90/10)
 Flow: 1.0 mL/min
 Temperature: 25°C
 Detection: UV at 254 nm

Column Care

The recommended pH range for using YMC CHIRAL CD BR columns is 3.5-6.5. Remove acid and buffer salts before storage. Store the column in methanol/water = 50/50. If columns are affected by undesired contaminants or clogged inlet frits which cause back pressure increases, flush the column with THF in the opposite flow direction.

For detailed information please refer to the "Column Care and Use Instructions" which can be downloaded from www.ymc.de.

Contract Purification of Chiral Compounds

In addition to chiral screening which can be carried out at our German or Japanese facilities, YMC can now offer contract purification of chiral compounds at a range of scales and by different techniques.

Highly productive

Highly efficient preparative separation methods (recycling chromatography, SFC, SMB)

Highly reliable

Extensive expertise and excellent performance in scaling up of chromatography purification



Cost competitive

Competitively priced YMC chiral packing materials used

Applicable to various scales

Equipped with dynamic axial compression columns with a maximum inner diameter of up to 1000 mm and HPLC systems with pumps up to a maximum flow rate of 50 L/min

GMP compliant purification service (opened in September 2015)

Scale	several mg - tens of g			tens of g - several tons		
Location	YMC Chiral Technologies Laboratory			YMC Komatsu Works		
	System	Column ID	Purpose	System	Column ID	Purpose
Equipment	Preparative HPLC LC-Forte/R	20, 30 mm	Purification of trace impurity, recycling purification of enantiomers	Dynamic Axial Compression Columns + K-Prep system	100 – 1000 mm max. flow rate 0.5 – 50 L/min	Production-scale purification of enantiomers
	K-Prep LAB	50 mm	Single column purification with stacked injections	Explosion proof recycling system	up to 1000 mm max. flow rate 50 L/min	Efficient purification of enantiomers
	Preparative SFC	20, 30 mm	Preparative SFC purification of enantiomers	Large SMB (Planned)	150 mm	Production-scale purification of API
	SMB	20, 30 mm	Continuous purification, simulation for scaling up SMB processes	GMP purification facility	300 – 800 mm	GMP compliant purification of pharmaceutical intermediates
						

Ordering Information

CHIRAL ART Amylose-C

Phase dimension	Column ID [mm]	Column length [mm]		Guard cartridges* with 10 mm length
		150	250	
5 µm	2	KAN99S05-1502WT	KAN99S05-2502WT	KAN99S05-01Q1GC (pack of 5)
	4.6	KAN99S05-1546WT	KAN99S05-2546WT	KAN99S05-0104GC (pack of 5)
	10	—	KAN99S05-2510WT	KAN99S05-0110CC (pack of 2)
	20	—	KAN99S05-2520WX	KAN99S05-0120CC (pack of 2)
	30	—	KAN99S05-2530WX	KAN99S05-0130CC (pack of 2)

CHIRAL ART Cellulose-C

Phase dimension	Column ID [mm]	Column length [mm]		Guard cartridges* with 10 mm length
		150	250	
5 µm	2	KCN99S05-1502WT	KCN99S05-2502WT	KCN99S05-01Q1GC (pack of 5)
	4.6	KCN99S05-1546WT	KCN99S05-2546WT	KCN99S05-0104GC (pack of 5)
	10	—	KCN99S05-2510WT	KCN99S05-0110CC (pack of 2)
	20	—	KCN99S05-2520WX	KCN99S05-0120CC (pack of 2)
	30	—	KCN99S05-2530WX	KCN99S05-0130CC (pack of 2)

CHIRAL ART Amylose-SA

Phase dimension	Column ID [mm]	Column length [mm]			Guard cartridges* with 10 mm length
		50	100	150	
3 µm	2	KSA99S03-0502WT	KSA99S03-1002WT	KSA99S03-1502WT	KSA99S03-01Q1GC (pack of 5)
	3	KSA99S03-0503WT	KSA99S03-1003WT	KSA99S03-1503WT	KSA99S03-0103GC (pack of 5)
	4.6	KSA99S03-0546WT	KSA99S03-1046WT	KSA99S03-1546WT	KSA99S03-0104GC (pack of 5)

CHIRAL ART Amylose-SA

Phase dimension	Column ID [mm]	Column length [mm]		Guard cartridges* with 10 mm length
		150	250	
5 µm	2	KSA99S05-1502WT	KSA99S05-2502WT	KSA99S05-01Q1GC (pack of 5)
	4.6	KSA99S05-1546WT	KSA99S05-2546WT	KSA99S05-0104GC (pack of 5)
	10	—	KSA99S05-2510WT	KSA99S05-0110CC (pack of 2)
	20	—	KSA99S05-2520WX	KSA99S05-0120CC (pack of 2)
	30	—	KSA99S05-2530WX	KSA99S05-0130CC (pack of 2)

*Guard cartridge holder required, part no. XPGCH-Q1 (2.1, 3, 4 mm ID)
 XPCHSPW1 (10 mm ID)
 XPCHSPW2 (20 mm ID)
 XPCHSPW3 (30 mm ID)

Ordering Information

CHIRAL ART Cellulose-SB

Phase dimension	Column ID [mm]	Column length [mm]			Guard cartridges* with 10 mm length
		50	100	150	
3 μ m	2	KSB99S03-0502WT	KSB99S03-1002WT	KSB99S03-1502WT	KSB99S03-01Q1GC (pack of 5)
	3	KSB99S03-0503WT	KSB99S03-1003WT	KSB99S03-1503WT	KSB99S03-0103GC (pack of 5)
	4.6	KSB99S03-0546WT	KSB99S03-1046WT	KSB99S03-1546WT	KSB99S03-0104GC (pack of 5)

CHIRAL ART Cellulose-SB

Phase dimension	Column ID [mm]	Column length [mm]		Guard cartridges* with 10 mm length
		150	250	
5 μ m	2	KSB99S05-1502WT	KSB99S05-2502WT	KSB99S05-01Q1GC (pack of 5)
	4.6	KSB99S05-1546WT	KSB99S05-2546WT	KSB99S05-0104GC (pack of 5)
	10	—	KSB99S05-2510WT	KSB99S05-0110CC (pack of 2)
	20	—	KSB99S05-2520WX	KSB99S05-0120CC (pack of 2)
	30	—	KSB99S05-2530WX	KSB99S05-0130CC (pack of 2)

CHIRAL ART Amylose-SE

Phase dimension	Column ID [mm]	Column length [mm]		Guard cartridges* with 10 mm length
		150	250	
5 μ m	2	KSE99S05-1502WT	KSE99S05-2502WT	KSE99S05-01Q1GC (pack of 5)
	4.6	KSE99S05-1546WT	KSE99S05-2546WT	KSE99S05-0104GC (pack of 5)
	10	—	KSE99S05-2510WT	KSE99S05-0110CC (pack of 2)
	20	—	KSE99S05-2520WX	KSE99S05-0120CC (pack of 2)
	30	—	KSE99S05-2530WX	KSE99S05-0130CC (pack of 2)

Launch of CHIRAL ART Amylose-SE scheduled for 2016.

CHIRAL ART Cellulose-SC

Phase dimension	Column ID [mm]	Column length [mm]		Guard cartridges* with 10 mm length
		150	250	
5 μ m	2	KSC99S05-1502WT	KSC99S05-2502WT	KSC99S05-01Q1GC (pack of 5)
	4.6	KSC99S05-1546WT	KSC99S05-2546WT	KSC99S05-0104GC (pack of 5)
	10	—	KSC99S05-2510WT	KSC99S05-0110CC (pack of 2)
	20	—	KSC99S05-2520WX	KSC99S05-0120CC (pack of 2)
	30	—	KSC99S05-2530WX	KSC99S05-0130CC (pack of 2)

*Guard cartridge holder required, part no. XPGCH-Q1 (2.1, 3, 4 mm ID)
 XPCHSPW1 (10 mm ID)
 XPCHSPW2 (20 mm ID)
 XPCHSPW3 (30 mm ID)

Ordering Information

Normal Phase: YMC CHIRAL NEA(R)(S)

Phase dimension	Column ID [mm]	Column length [mm]				Guard cartridges* with 10 mm length [pack of 5]
		50	100	150	250	
30 nm 5 μ m NEA(R)	4.6	CR30S05-0546WT	CR30S05-1046WT	CR30S05-1546WT	CR30S05-2546WT	CR30S05-0104GC
30 nm 5 μ m NEA(S)	4.6	CS30S05-0546WT	CS30S05-1046WT	CS30S05-1546WT	CS30S05-2546WT	CS30S05-0104GC

*Guard cartridge holder required, part no. XPGCH-Q1

Reversed Phase: YMC CHIRAL NEA(R)(S)

Phase dimension	Column ID [mm]	Column length [mm]				Guard cartridges* with 10 mm length [pack of 5]
		50	100	150	250	
30 nm 5 μ m NEA(R)	4.6	NR30S05-0546WT	NR30S05-1046WT	NR30S05-1546WT	NR30S05-2546WT	NR30S05-0104GC
30 nm 5 μ m NEA(S)	4.6	NS30S05-0546WT	NS30S05-1046WT	NS30S05-1546WT	NS30S05-2546WT	NS30S05-0104GC

*Guard cartridge holder required, part no. XPGCH-Q1

α -CD BR: YMC CHIRAL CD BR

Phase dimension	Column ID [mm]	Column length [mm]				Guard cartridges* with 10 mm length [pack of 5]
		50	100	150	250	
12 nm 5 μ m	4.6	DA12S05-0546WT	—	DA12S05-1546WT	DA12S05-2546WT	DA12S05-0104GC

*Guard cartridge holder required, part no. XPGCH-Q1

β -CD BR: YMC CHIRAL CD BR

Phase dimension	Column ID [mm]	Column length [mm]				Guard cartridges* with 10 mm length [pack of 5]
		50	100	150	250	
12 nm 5 μ m	4.6	DB12S05-0546WT	—	DB12S05-1546WT	DB12S05-2546WT	DB12S05-0104GC

*Guard cartridge holder required, part no. XPGCH-Q1

γ -CD BR: YMC CHIRAL CD BR

Phase dimension	Column ID [mm]	Column length [mm]				Guard cartridges* with 10 mm length [pack of 5]
		50	100	150	250	
12 nm 5 μ m	4.6	DG12S05-0546WT	—	DG12S05-1546WT	DG12S05-2546WT	DG12S05-0104GC

*Guard cartridge holder required, part no. XPGCH-Q1





Alcyon SFC Columns

Contents

General	276
Fast Separation with High Resolution	277
Excellent Peak Shape	277
High Column Stability	278
Separation of Phenols	279
Ordering Information.....	280

Introduction

The advantages of Supercritical Fluid Chromatography (SFC) compared to Liquid Chromatography include faster separations, ease of sample recovery, reduced solvent consumption and therefore costs. To meet the needs of this mode of separation, YMC has introduced a range of achiral and chiral products dedicated for use in SFC: Alcyon.

The column hardware is specifically designed for SFC applications. Each Alcyon SFC column is delivered with a column inspection report prepared in SFC mode to allow easy comparisons of standard tests without any requirement to change separation mode.

Alcyon SFC

- cost efficient: reduced solvent consumption!
- time saving: faster separations with high resolution
- flexible: chiral and achiral stationary phases



CHIRAL	Alcyon Coated Polysaccharides		Alcyon Immobilised Polysaccharides	
	Alcyon SFC CSP Amylose-C	Alcyon SFC CSP Cellulose-C	Alcyon SFC CSP Amylose-SA	Alcyon SFC CSP Cellulose-SB
Chiral selector	Amylose tris (3,5-dimethyl-phenylcarbamate)	Cellulose tris (3,5-dimethyl-phenylcarbamate)	Amylose tris (3,5-dimethyl-phenylcarbamate)	Cellulose tris (3,5-dimethyl-phenylcarbamate)
USP	L51	L40	—	—
Particle size / μm	5	5	5	5
pH range	3.5 - 6.5	3.5 - 6.5	2.0 - 9.0	2.0 - 9.0
Shipping solvent	2-propanol	2-propanol	2-propanol	2-propanol
Pressure limit	Inner diameter of 2.1 and 4.6 mm: 30 MPa (4350 psi) Inner diameter of 10 and 20 mm: 20 MPa (2980 psi)			

ACHIRAL	Alcyon SFC Triart C18	Alcyon SFC Triart Diol	Alcyon SFC Triart PFP	Alcyon SFC CN	Alcyon SFC SIL
	$-\text{C}_{18}\text{H}_{37}$	$-\text{CH}_2\text{CH}(\text{OH})\text{CH}_2\text{OH}$	$-(\text{CH}_2)_3$	$-(\text{CH}_2)_3-\text{CN}$	$-\text{OH}$
USP	L1	L20	L43	L10	L3
Particle size / μm	5	5	5	5	5
Pore size / nm	12	12	12	12	12
pH range	1.0 - 12.0	2.0 - 10.0	1.0 - 8.0	2.0 - 7.5	2.0 - 7.5
Shipping solvent	2-propanol	2-propanol	2-propanol	2-propanol	2-propanol
Pressure limit	Inner diameter of 2.1 and 4.6 mm: 30 MPa (4350 psi) Inner diameter of 10 and 20 mm: 20 MPa (2980 psi)				

Alcyon SFC

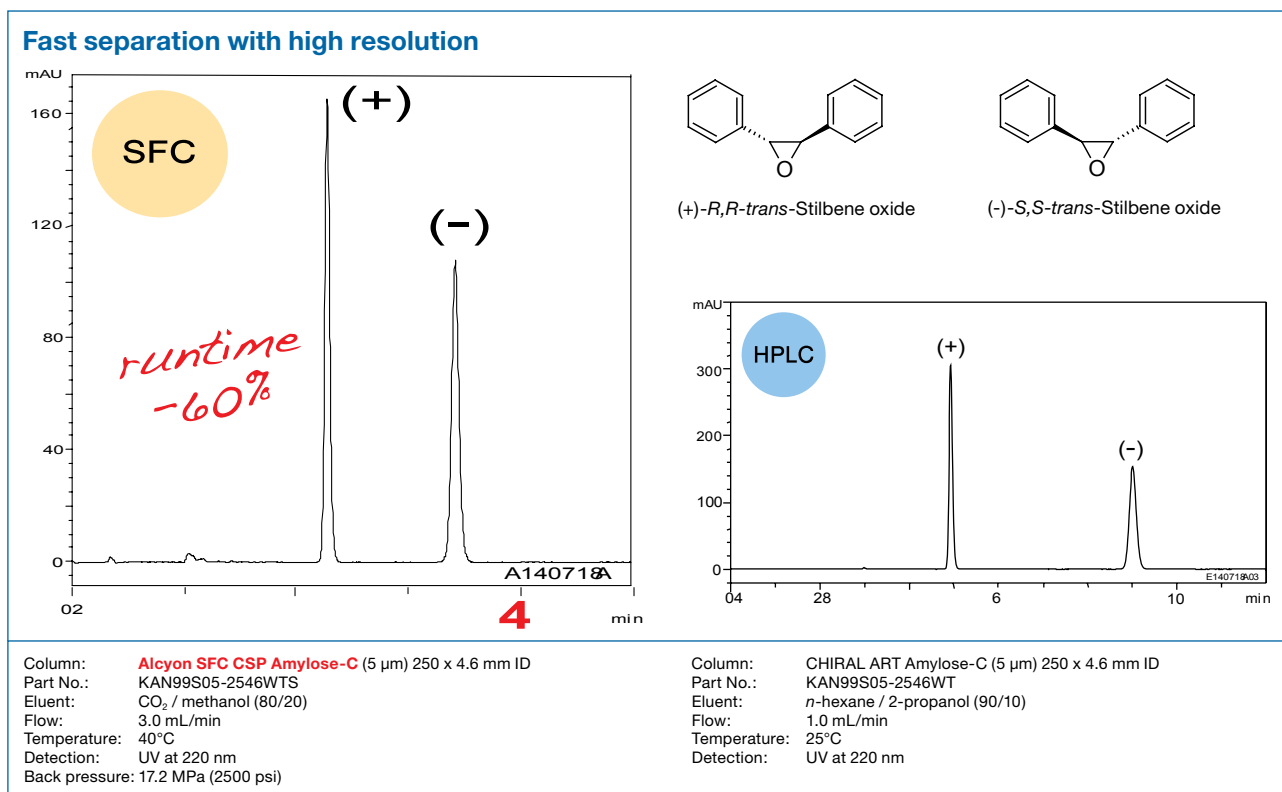

Faster chiral separation of *trans*-stilbene oxide is achieved using supercritical fluid chromatography compared to HPLC as the separation mode. Lower viscosity and larger diffusion coefficients for supercritical fluid provide rapid separations of both chiral and achiral compounds.

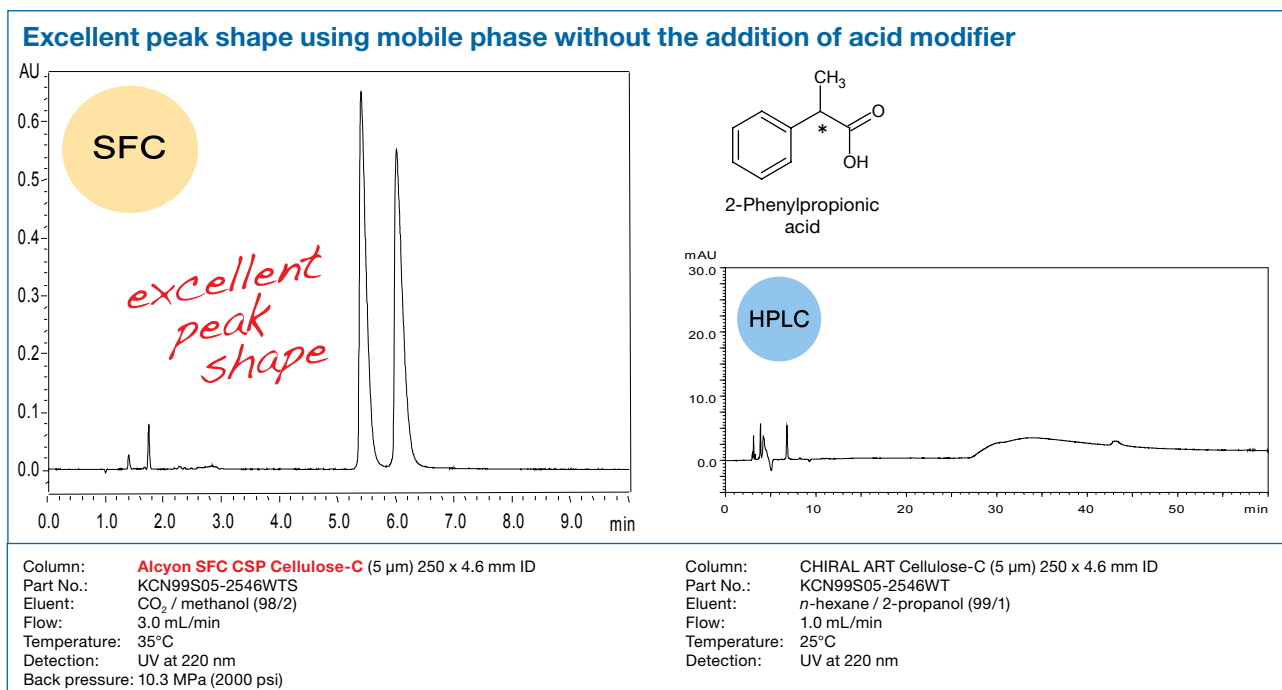

Excellent peak shape of 2-phenylpropionic acid is obtained using SFC chiral separation. Under HPLC conditions, the peak shape is very broad with mobile phase containing no additives such as an acid. With SFC, on the other hand, peak shapes are very good just with mixture of CO₂ and methanol. It is thought that supercritical carbon dioxide acts as an acid.

Alcyon SFC

High column stability under repeated back pressure gradient condition

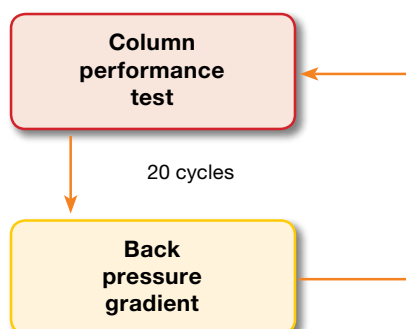

Stability of theoretical plate number

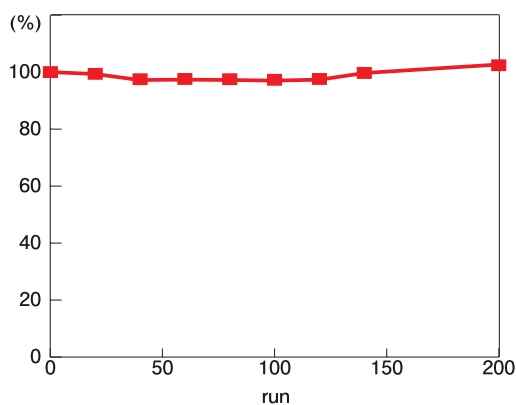

Stability test

Column: **Alcyon SFC CSP Amylose-C** (5 μm) 250 x 4.6 mm ID
 Part No.: KAN99S05-2546WTS
 Eluent: CO_2 / methanol (80/20)
 Flow: 1.0 mL/min
 Temperature: 50°C
 Back pressure: 10.3 MPa (1500 psi) - 24.1 MPa (3500 psi) (0-10 min)
 10.3 MPa (1500 psi) (10-13 min)

Stability of retention time

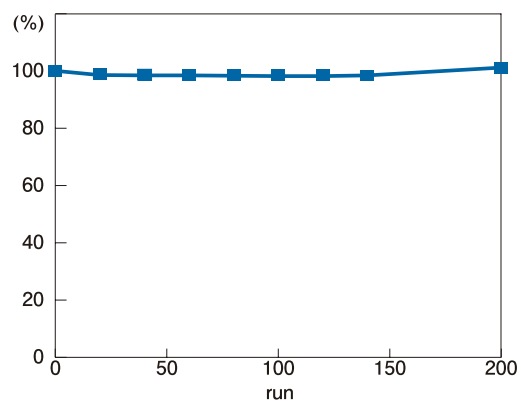

Column performance test (every 20 gradient cycles)

Column: **Alcyon SFC CSP Amylose-C** (5 μm) 250 x 4.6 mm ID
 Part No.: KAN99S05-2546WTS
 Eluent: CO_2 / methanol (80/20)
 Flow: 3.0 mL/min
 Temperature: 50°C
 Detection: UV at 220 nm
 Back pressure: 10.3 MPa (1500 psi)
 Sample: *trans*-stilbene oxide

Results for the sequential analysis under back pressure gradient conditions using Alcyon SFC CSP Amylose-C are shown above. Theoretical plate numbers and retention times are maintained even after the sequential gradient test. Alcyon SFC columns have excellent stability under such demanding conditions.

Alcyon SFC

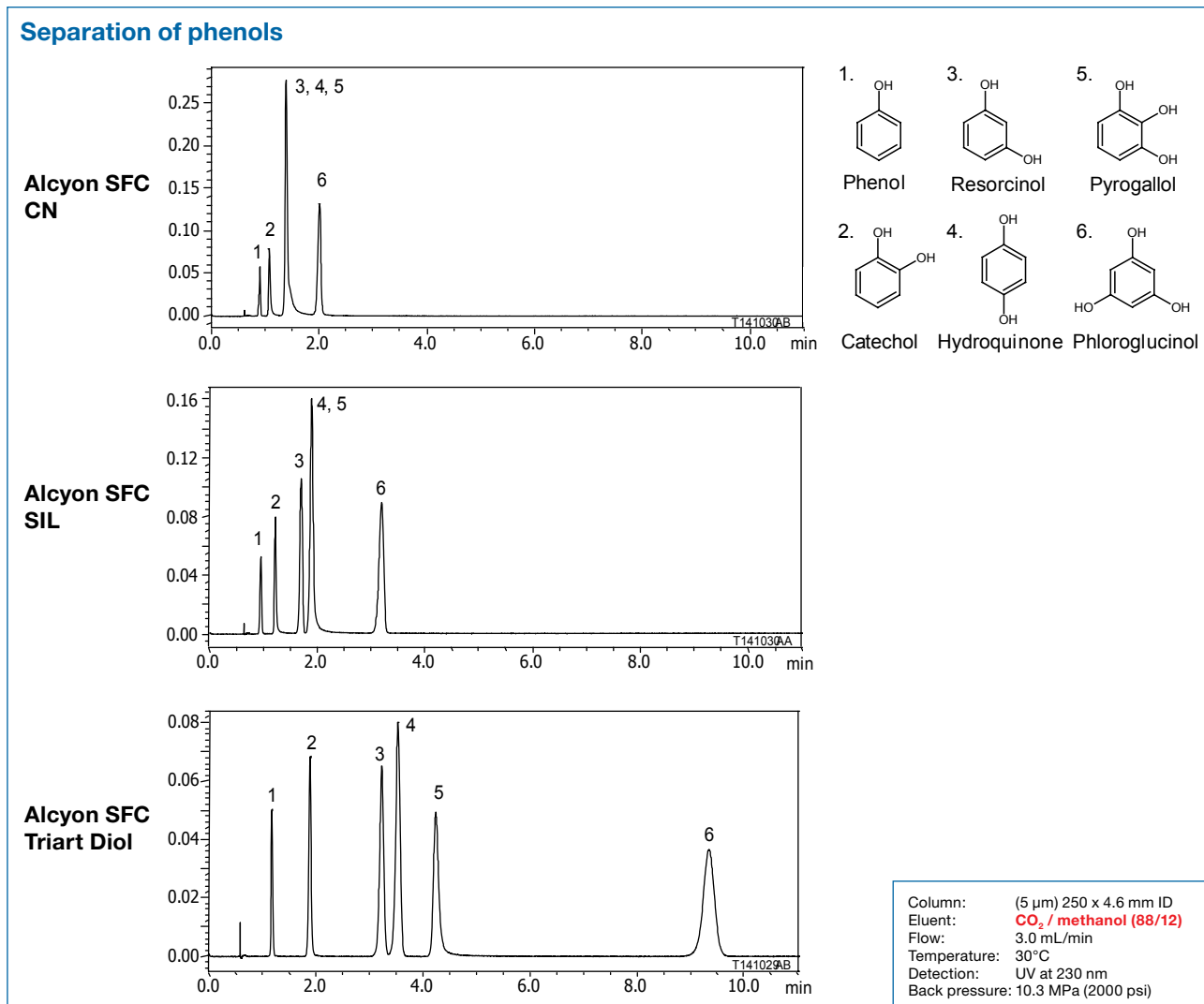

The results for the analysis of six phenols using three different achiral columns are shown. Alcyon SFC Triart Diol shows the best separation in this case.

Ordering Information

CHIRAL

Particle size	Column size length x ID [mm]	Product number			
		Coated type		Immobilised type	
		Alcyon SFC CSP Amylose-C	Alcyon SFC CSP Cellulose-C	Alcyon SFC CSP Amylose-SA	Alcyon SFC CSP Cellulose-SB
5 µm	150 x 2.1	KAN99S05-15Q1WTS	KCN99S05-15Q1WTS	KSA99S05-15Q1WTS	KSB99S05-15Q1WTS
	150 x 4.6	KAN99S05-1546WTS	KCN99S05-1546WTS	KSA99S05-1546WTS	KSB99S05-1546WTS
	250 x 4.6	KAN99S05-2546WTS	KCN99S05-2546WTS	KSA99S05-2546WTS	KSB99S05-2546WTS
	250 x 10	KAN99S05-2510WTS	KCN99S05-2510WTS	KSA99S05-2510WTS	KSB99S05-2510WTS
	250 x 20	KAN99S05-2520WTS	KCN99S05-2520WTS	KSA99S05-2520WTS	KSB99S05-2520WTS

ACHIRAL

Particle size	Column size length x ID [mm]	Product number				
		Alcyon SFC Triart C18	Alcyon SFC Triart Diol	Alcyon SFC Triart PFP	Alcyon SFC CN	Alcyon SFC SIL
5 µm	150 x 2.1	TA12S05-15Q1WTS	TDN12S05-15Q1WTS	TPF12S05-15Q1WTS	CN12S05-15Q1WTS	SL12S05-15Q1WTS
	150 x 4.6	TA12S05-1546WTS	TDN12S05-1546WTS	TPF12S05-1546WTS	CN12S05-1546WTS	SL12S05-1546WTS
	250 x 4.6	TA12S05-2546WTS	TDN12S05-2546WTS	TPF12S05-2546WTS	CN12S05-2546WTS	SL12S05-2546WTS
	250 x 10	TA12S05-2510WTS	TDN12S05-2510WTS	TPF12S05-2510WTS	CN12S05-2510WTS	SL12S05-2510WTS
	250 x 20	TA12S05-2520WTS	TDN12S05-2520WTS	TPF12S05-2520WTS	CN12S05-2520WTS	SL12S05-2520WTS

Additional SFC columns

Particle size	Column size length x ID [mm]	Product number			
		YMC-Pack 2-Ethyl pyridine	YMC-Pack Diethylaminopropyl	YMC-Pack Propyl acetamide	YMC-Pack Pyridine amide
5 µm	250 x 4.6	EP06S05-2546PS	DE06S05-2546PS	PP06S05-2546PS	PY06S05-2546PS
	250 x 21.2	EP06S05-2521PS	DE06S05-2521PS	PP06S05-2521PS	PY06S05-2521PS
	250 x 30	EP06S05-2530PS	DE06S05-2530PS	PP06S05-2530PS	PY06S05-2530PS



Speciality Columns

Contents

YMC Carotenoid	284-285
YMC PAH.....	286-287
J'sphere ODS.....	288-293
Ordering Information.....	294

Introduction

Unique bonded phases

The YMC's Speciality Columns represents major advances in modern chromatography. In order to obtain maximum separation and resolution, selectivity has to be optimised.

YMC is dedicated to produce speciality phases, which are designed to provide robust, reliable and easy transferable methods for specific applications. For this reason, YMC introduce YMC Carotenoid and YMC PAH phases, which are designed to show high recognition for structurally similar polar and nonpolar carotenoids and polyaromatic hydrocarbons, respectively.

In addition, YMC's J'sphere columns are a series of packings, which offer a range of different hydrophobicity controlled by the alternative process of C18 chain density.

YMC Carotenoid

- C30 chains
- very lipophilic
- exceptional selectivity pattern
- isomer recognition

- polar carotenes
- polar and nonpolar xanthophylls
- steroids
- retinols
- fat-soluble vitamins
- LC-MS applications



YMC Carotenoid	Specification
Particle Size / μm	3; 5
Pore Size / nm	proprietary
Surface area / m^2g^{-1}	proprietary
Carbon content / %	proprietary
Recommended pH range	2.0 - 7.5

General

The separation of geometric and positional isomers is a challenging task in reversed phase chromatography. Subtle molecular differences have to be recognized and resolved by this particular stationary phase. Sander et al. have conclusively shown that polymeric C30 HPLC stationary phases are able to discriminate isomeric structures of long chain molecules [1,2].

Properties

Compared to classical C18 stationary phases, YMC Carotenoid is much more hydrophobic. Even when pure organic eluents are applied, many sample solutes are retained. The use of non-aqueous reversed phase mobile phases facilitates 100% solvent recycling and LC-MS applications.

The YMC Carotenoid stationary phase provides sufficient phase thickness to enhance interaction with long chained molecules (see figure on right). Therefore, geometric and positional isomers of conjugated double bonding systems are recognised and resolved by the YMC Carotenoid phase.

The resolving power of YMC Carotenoid for isomers can be verified by the separation of carotenoids, which has been subject of considerable research efforts in the past. Carotenoids are found in a variety of natural sources including fruits and vegetables. In addition, carotenoids are considered as potential drugs for cancer intervention or prevention. Despite the complexity of carotenoid extracts and the minor shape differences between carotenoid isomers, the separation, identification and quantification of these compounds can be achieved by using YMC Carotenoid columns.

Applications

YMC Carotenoid columns are successfully used in the food industry, for the analysis of vitamin formulations, in environmental analysis, and for the control of algal growth. Other potential applications include the separation of prostaglandins and leucotrienes.

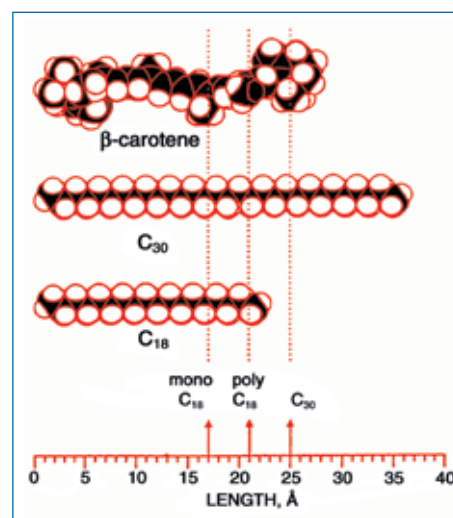

Comparison of the film thickness of C18 and C30 stationary phases with the molecular length of β -carotene (determined with Small Angle Neutron Scattering (SANS)).

YMC Carotenoid

Separation of natural compounds

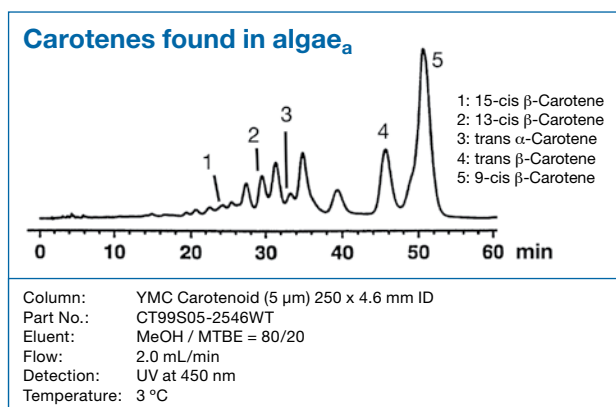
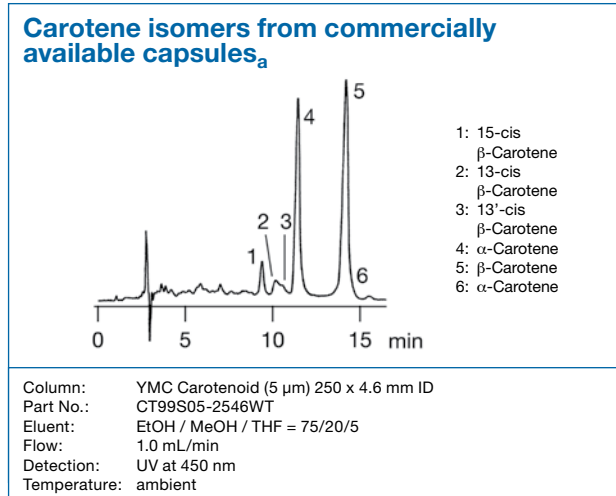
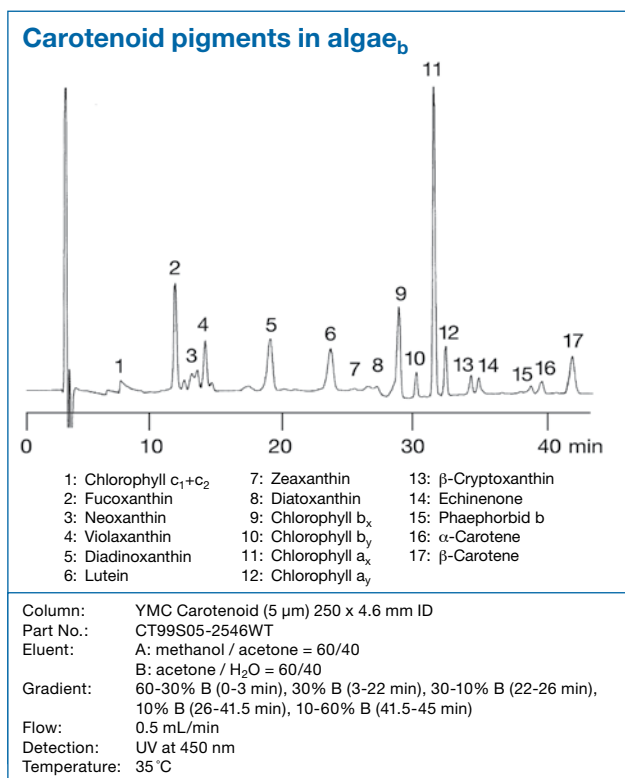
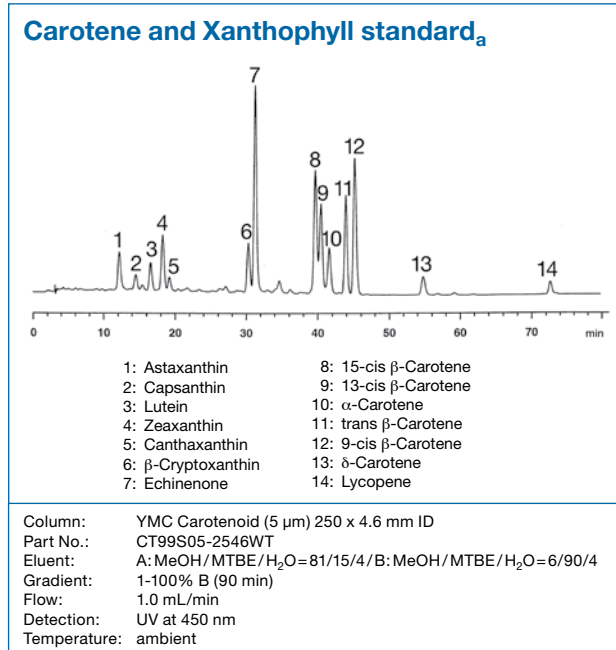
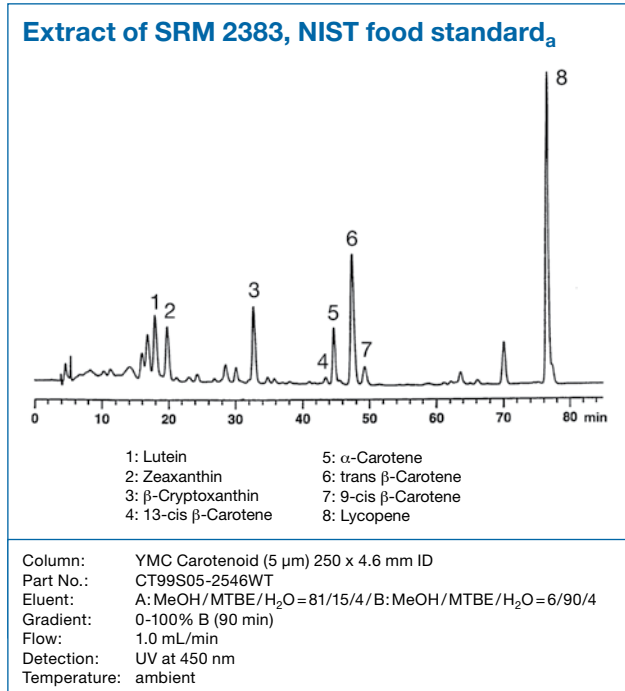

References

- [1] Sander, L.C. and S.A. Wise; *J. Chromatogr.* 1993, 656, 335-351
[2] Sander, L.C. et al.; *Anal. Chem.* 1994, 66, 1667-1674
[3] Block, G. and L. Langseth, "Antioxidant Vitamins and Disease Prevention", *Food Technology* July 1994

^a Courtesy of L.C. Sander, NIST, Gaithersburg, NC, USA

^b Courtesy of J. Schmid, Institut für Seenforschung, Langenargen, Germany

For more applications please refer to our "Application Data Collections" or contact us directly.

YMC PAH

- specifically designed for the analysis of Polynuclear Aromatic Hydrocarbons
- provides the resolution necessary for a fast identification and quantification for PAHs



YMC PAH	Specification
Particle Size / μm	3; 5
Pore Size / nm	proprietary
Surface area / m^2g^{-1}	proprietary
Carbon content / %	proprietary
Recommended pH range	2.0 - 6.5

General

Polynuclear Aromatic Hydrocarbons (PAHs) are among the most frequently monitored environmental contaminants. YMC PAH columns have been specifically developed for the highly demanding analysis of Polynuclear Aromatic Hydrocarbons.

Standard and official methods for the analysis of PAHs are found in compendia for air, drinking water, waste water, solid waste, and food analysis. Many of these methods specify HPLC, usually with UV or fluorescence detection, as recommended analytical procedure.

Properties

The YMC PAH columns provide narrow symmetrical peak shapes and its resolving ability leads to an easy identification and quantification for PAHs. The optimised selectivity of YMC PAH columns results in a separation with enough space for wavelength changes by the use of fluorescence detectors.

16 PAH according to EPA 610

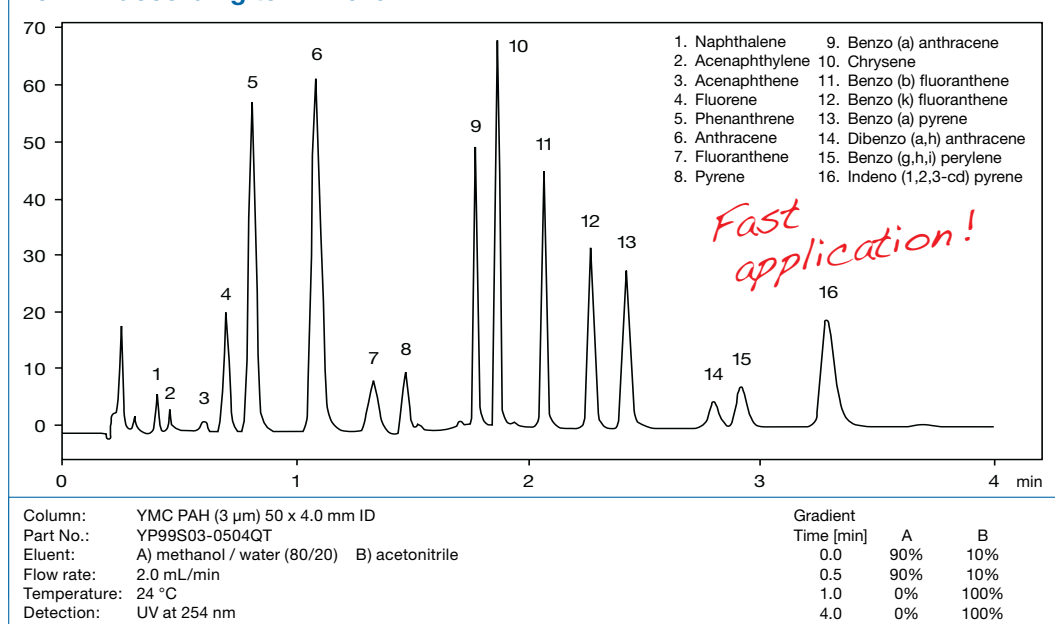

YMC PAH

16 PAH according to EPA 610

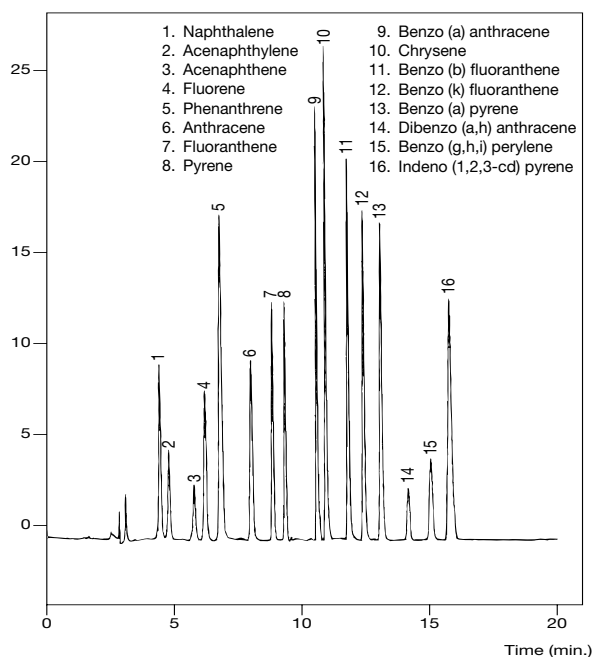

Column: YMC PAH (5 μ m) 250 x 3.0 mm ID
 Part No.: YP99S05-2503QT
 Eluent: A) MeOH / water (80/20) / B) acetonitrile
 Flow rate: 0.43 mL/min
 Temperature: 30 °C
 Detection: UV at 254 nm

PCB separation according EPA

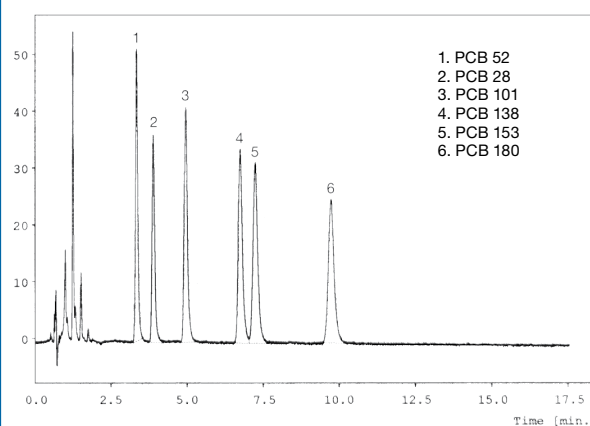

Column: YMC PAH (3 μ m) 100 x 3.0 mm ID
 Part No.: YP99S05-1003QT
 Eluent: CH₃CN / water (75/25)
 Flow rate: 0.6 mL/min
 Temperature: 30 °C
 Detection: UV at 220 nm

Polynuclear Aromatic Hydrocarbons (PAHs) are ubiquitous xenobiotics which are known or suspected carcinogens. According to the German Trinkwasserverordnung (TVO) six PAH have to be quantified. Moreover Perylene, which is often present in the samples under investigation, has to be fully resolved in order to avoid coelutions and therefore questionable results.

The chromatogram below shows the successful separation of all seven substances with a YMC PAH column as stationary and an acetonitrile/methanol mixture as a simple isocratic mobile phase. The elution time has been reduced to approximately six minutes with excellent resolution without the need for gradient elution.

7 PAH according to EPA 610

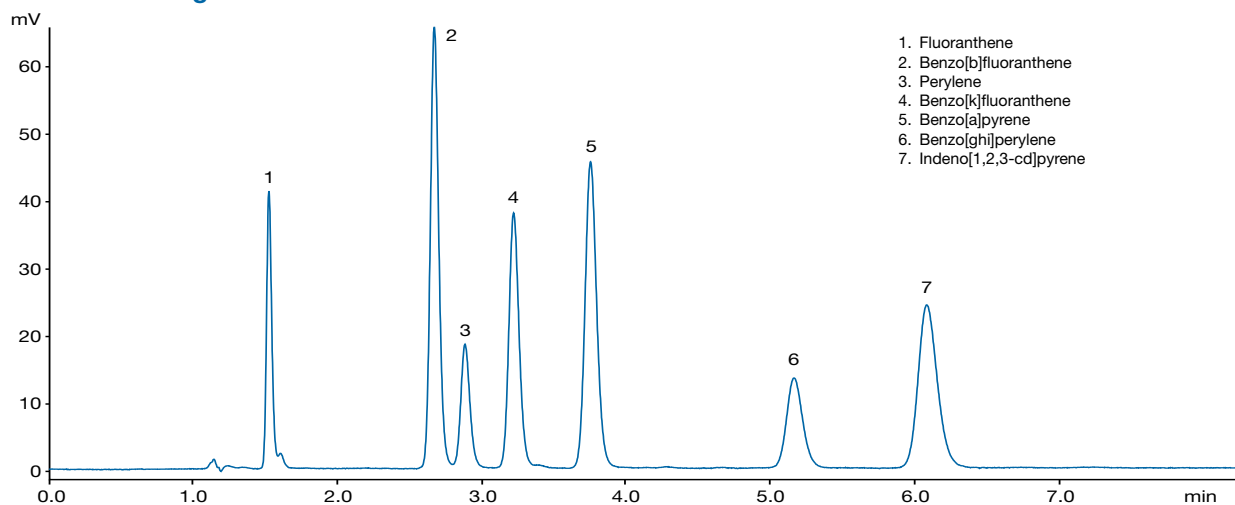

Column: YMC PAH (5 μ m) 125 x 4.0 mm ID
 Part No.: YP99S05-R504QT
 Eluent: acetonitrile / methanol (95/5)
 Flow rate: 1.0 mL/min
 Temp.: 25 °C
 Detection: UV at 254 nm
 Inj.-vol.: 5 μ L

J'sphere ODS

- high quality RP columns
- high surface silica, 8 nm, 4 μm
- polarity range created solely by C18 bonding density
- metabolite recognition
- high siloxane content
- additional selectivity through H-bonding

a selectivity concept designed for

- quality control
- pharmaceuticals
- organic intermediates
- hormones, steroids

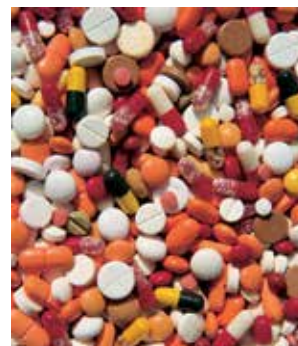

J'sphere ODS	JH	JM	JL
Particle Size / μm	4	4	4
Pore Size / nm	8	8	8
Surface area / m^2g^{-1}	510	510	510
Carbon content / %	22	14	9
Recommended pH range	1.0 - 9.0	2.0 - 7.5	2.0 - 7.5

General

Alkyl chains of different lengths, including C18, C8 and C4, are commonly used for bonding during the synthesis of conventional reversed stationary phases of different polarity. YMC however, have applied another approach for creating divergent polarities and improving the consistency in the synthesis of reversed phase packings. With J'sphere ODS, the alkyl chain length is kept constant (as C18), but the content of C18 groups on the silica surface is varied to produce the three different J'sphere ODS packings with graduated hydrophobicity (see figure below).

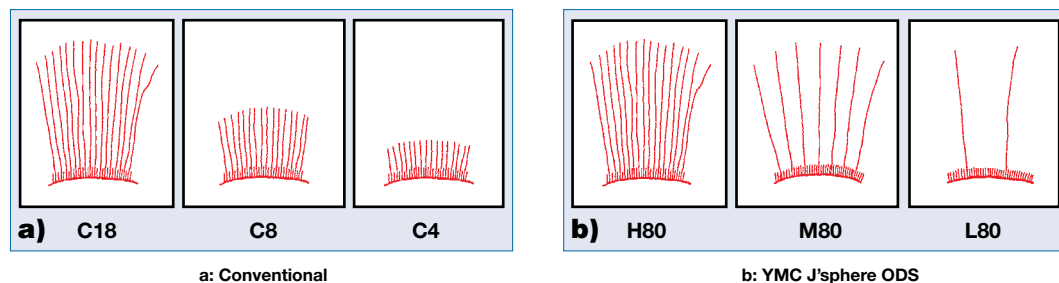

Schematic comparison of reversed phases of different polarity.

Physico-Chemical Properties

J'sphere ODS packings are based on a spherical, ultra pure, high surface area silica with a mean pore diameter of 8 nm and a mean particle diameter of 4 μm .

J'sphere silica has a very homogeneous surface providing additional siloxane groups. They are almost of the same nature as ether groups and they are able to form H-bonding which is of great importance for the retentivity and selectivity of J'sphere ODS bonded phases.

J'sphere ODS

An elaborate endcapping process is applied to react the remaining silanols to effectively suppress the undesired non-specific interactions (see figure below).

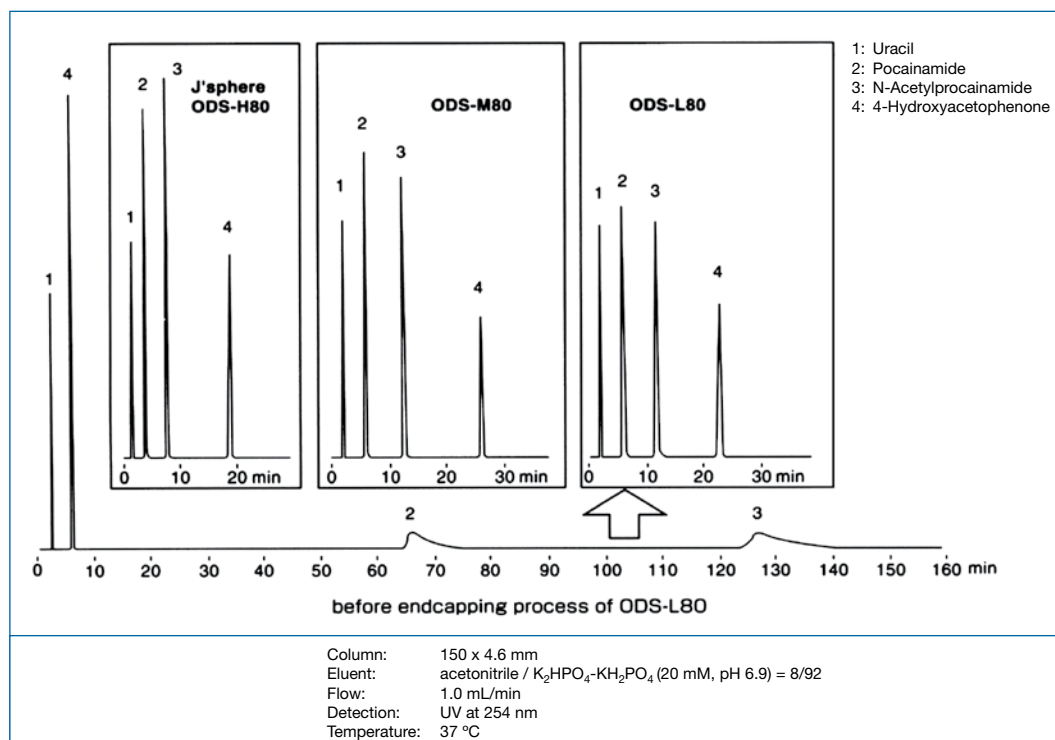

Three types of ODS are processed by endcapping technology to minimize the effect of residual silanol as much as possible.

The stepwise decrease of hydrophobicity in the J'sphere ODS-H80, M80 and L80 series is accompanied by a corresponding increase in the H-bonding capacity (see figure right). If a sample molecule is susceptible to H-bonding, the resulting interaction represents additional retention and enhances the selectivity in RP separations.

Selectivity Data

The exclusive use of C18 groups makes the hydrophobic interaction identical for all three types of J'sphere ODS packings; only the degree of hydrophobicity, i.e. the polarity, is varied.

In addition to the hydrophobic interaction, the surface siloxane groups of J'sphere ODS packings provide a pronounced H-bonding capacity contributing additional selectivity. The ability to interact strongly via H-bonding, creates the opportunity to make use of an additional degree of freedom in selectivity. The "controlled hydrogen bonding capacity" of YMC J'sphere ODS packings represents an efficient tool for the chromatographic discrimination of closely related compounds presenting only minor molecular differences.

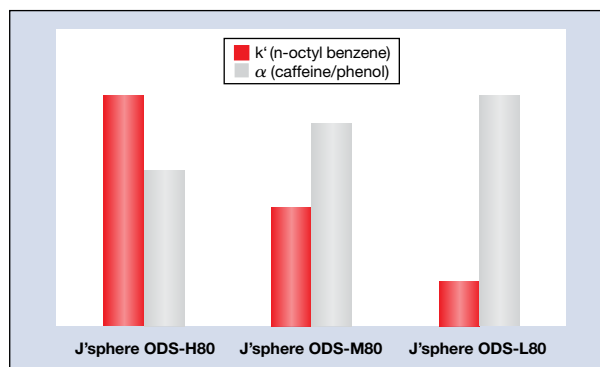

Hydrophobicity (indicated by k' for n-octyl benzene) and H-bonding capacity (indicated by α of caffeine/phenol) of J'sphere ODS columns.

J'sphere ODS

Applications

J'sphere ODS-H80

J'sphere ODS-H80 is the most hydrophobic stationary phase in this series. It is densely covered with polymeric bonded C18 groups yielding a high carbon content and providing a strong, dominant, lipophilic interaction with the nonpolar sites of the sample molecules. However, the ability to form H-bonding gives additional selectivity, which is essential for difficult separations, such as drug and corresponding metabolite discrimination. Even stereoisomers can be separated by J'sphere ODS-H80 columns.

J'sphere ODS-M80

The lower coverage of C18 monomeric bonded groups in J'sphere ODS-M80 provides moderate hydrophobicity. As the lipophilic character is decreased, the H-bonding capacity becomes more and more important. J'sphere ODS-M80 has a pronounced balanced polarity which is extraordinary flexible and allows application to a wide variety of separation problems. Depending on the separation, J'sphere ODS-M80 columns can be operated over a very broad range of eluent polarity. J'sphere ODS-M80 columns are a very adaptable tool in various fields in analytical HPLC including drug analysis and QC.

J'sphere ODS-L80

J'sphere ODS-L80 has a low polymeric bonded C18 coverage, providing only minor hydrophobic retention. The extremely high H-bonding capacity makes J'sphere ODS-L80 very useful for the separation of polar compounds. Such compounds frequently have molecular sites which are susceptible to H-bonding and hence, are easily separated by a H-bonding mechanism.

Conclusion

By using the graduated properties of J'sphere ODS columns, a great variety of chemical and pharmaceutical applications can be achieved. YMC J'sphere ODS analytical columns are a good choice for the analysis of pharmaceuticals, organic intermediates, metabolites etc., due to their concept of fine-tuned approach by using different H-bonding capacities.

Quality Specifications

Based on the experience in high performance analytical selectivities and large scale silicas synthesis and bonded phases, the long term availability of high quality analytical J'sphere ODS columns is guaranteed. Sophisticated selectivity tests for quality control ensure reproducible separations. These quality control tests guarantee the customer long term reproducible performance, which is essential for the validated analytical HPLC methods.

J'sphere ODS-H80

Elution profile of complexing agents*

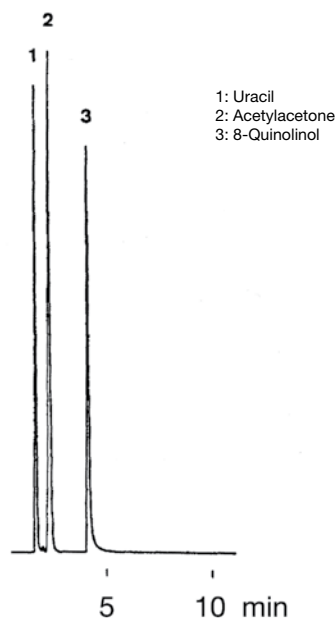

Column: J'sphere ODS-H80 (8 nm, 4 μ m) 150 x 4.6 mm ID
Part No.: JH08S04-1546WT
Eluent: K_2HPO_4 - KH_2PO_4 (20 mM, pH 6.9) / methanol = 40/60
Flow: 1.0 mL/min
Detection: UV at 254 nm
Temperature: 37 $^{\circ}$ C

Triazine herbicides*

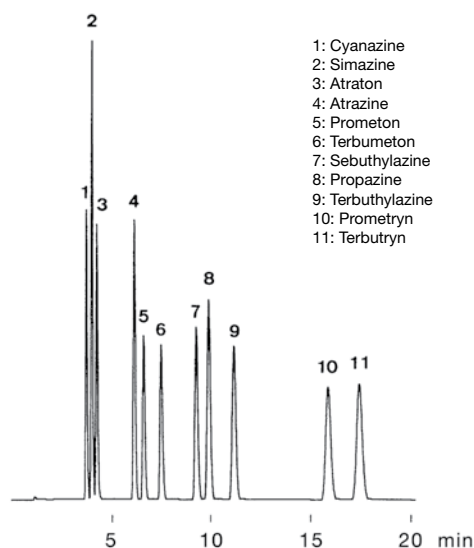

Column: J'sphere ODS-H80 (8 nm, 4 μ m) 150 x 4.6 mm ID
Part No.: JH08S04-1546WT
Eluent: acetonitrile / $NH_4H_2PO_4$ (50 mM) = 45/55
Flow: 1.0 mL/min
Detection: UV at 230 nm
Temperature: 37 $^{\circ}$ C

Thiamine and derivatives*

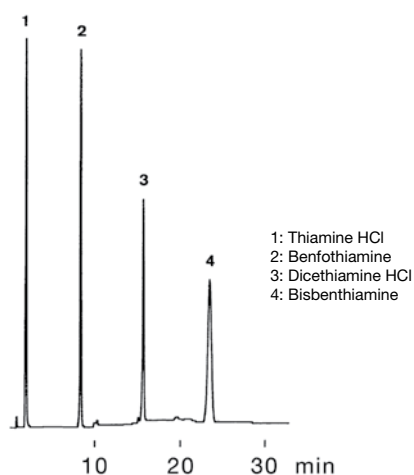

Column: J'sphere ODS-H80 (8 nm, 4 μ m) 75 x 4.6 mm ID
Part No.: JH08S04-L546WT
Eluent: A: $(NH_4)_2HPO_4$ (50 mM)
B: methanol / $(NH_4)_2HPO_4$ (50 mM) = 60/40
Gradient: 10-100% B (0-15 min, linear), 100% B (15-30 min)
Flow: 1.0 mL/min
Detection: UV at 260 nm
Temperature: 37 $^{\circ}$ C

Urea herbicides*

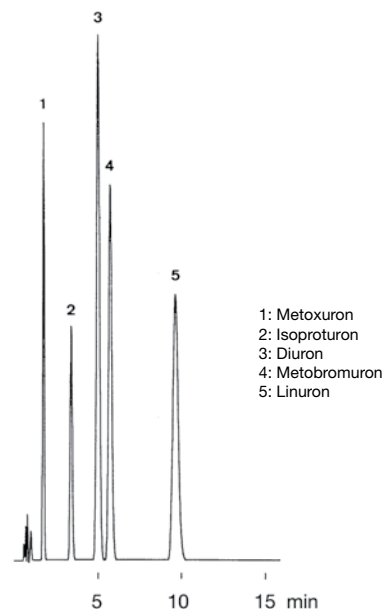

Column: J'sphere ODS-H80 (8 nm, 4 μ m) 150 x 4.6 mm ID
Part No.: JH08S04-1546WT
Eluent: THF / H_2O = 30/70
Flow: 1.0 mL/min
Detection: UV at 260 nm
Temperature: 37 $^{\circ}$ C

J'sphere ODS-M80

Catechins*

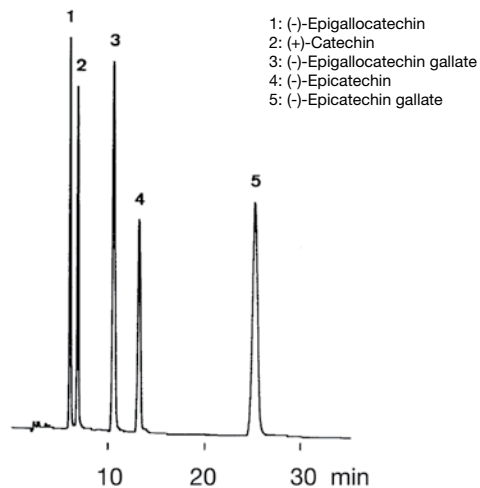

Column: J'sphere ODS-M80 (8 nm, 4 μ m) 150 x 4.6 mm ID
Part No.: JM08S04-1546WT
Eluent: KH_2PO_4 - H_3PO_4 (pH 2.4) / methanol = 75/25
Flow: 0.8 mL/min
Detection: UV at 280 nm
Temperature: 37 $^\circ\text{C}$

Nicotinic acid analogues*

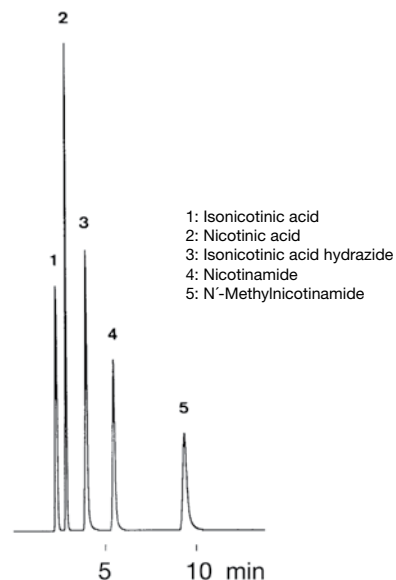

Column: J'sphere ODS-M80 (8 nm, 4 μ m) 150 x 4.6 mm ID
Part No.: JM08S04-1546WT
Eluent: acetonitrile / KH_2PO_4 (20 mM) = 5/95
Flow: 1.0 mL/min
Detection: UV at 260 nm
Temperature: 30 $^\circ\text{C}$

Aflatoxins*

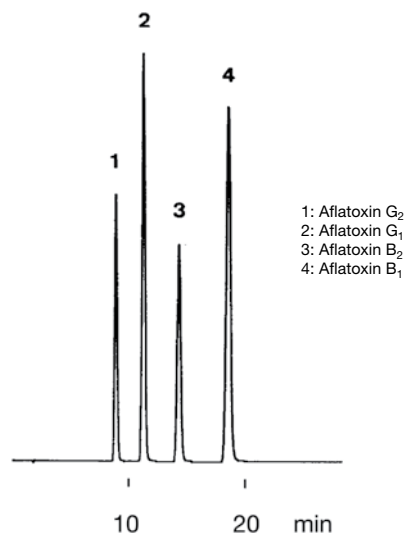

Column: J'sphere ODS-M80 (8 nm, 4 μ m) 150 x 4.6 mm ID
Part No.: JM08S04-1546WT
Eluent: methanol / water = 40/60
Flow: 1.0 mL/min
Detection: UV at 365 nm
Temperature: 37 $^\circ\text{C}$

Cephalosporin antibiotics*

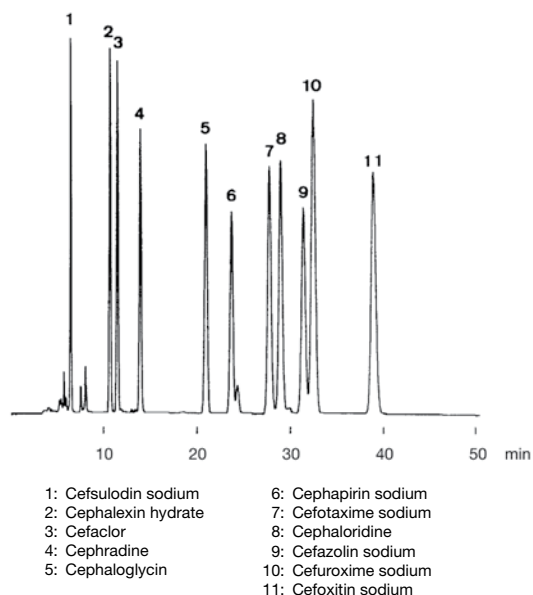

Column: J'sphere ODS-M80 (8 nm, 4 μ m) 250 x 4.6 mm ID
Part No.: JM08S04-2546WT
Eluent: acetonitrile / KH_2PO_4 (100 mM) = 10/90
Flow: 0.8 mL/min
Detection: UV at 260 nm
Temperature: 37 $^\circ\text{C}$

J'sphere ODS-L80

Adrenocorticosteroids*

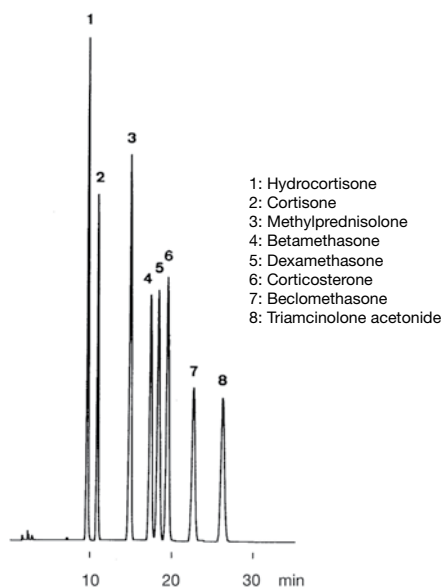

Column: J'sphere ODS-L80 (8 nm, 4 μ m) 150 x 4.6 mm ID
Part No.: JL08S04-1546WT
Eluent: acetonitrile / water = 27/73
Flow: 1.0 mL/min
Detection: UV at 260 nm
Temperature: 37 °C

Saikosaponins*

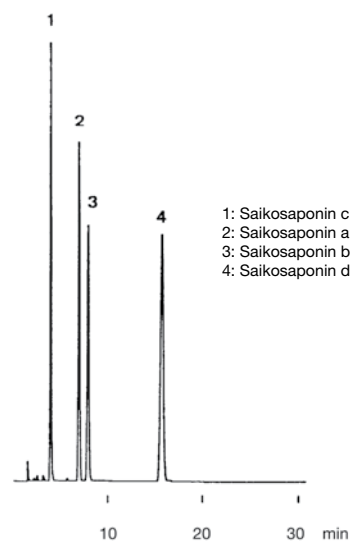

Column: J'sphere ODS-L80 (8 nm, 4 μ m) 150 x 4.6 mm ID
Part No.: JL08S04-1546WT
Eluent: acetonitrile / water = 38/62
Flow: 1.0 mL/min
Detection: UV at 210 nm
Temperature: 37 °C

Antibacterial agents*

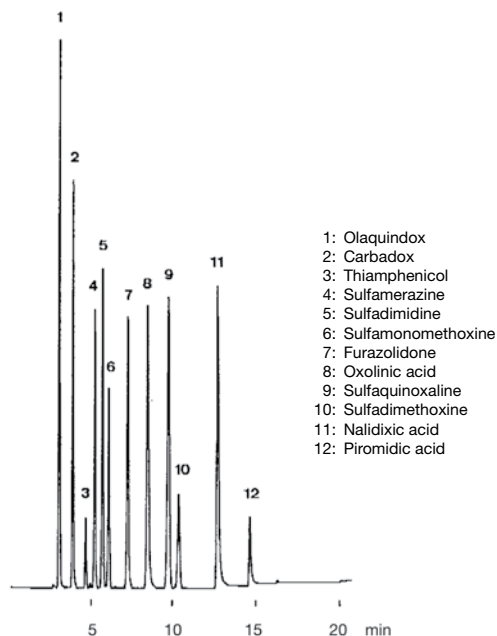

Column: J'sphere ODS-L80 (8 nm, 4 μ m) 250 x 4.6 mm ID
Part No.: JL08S04-2546WT
Eluent: A: acetonitrile / NH₄H₂PO₄ (50 mM) = 10/90
B: acetonitrile / NH₄H₂PO₄ (50 mM) = 80/20
Gradient: 25% B (0-5 min), 25-100% B (5-15 min), 100% B (15-20 min)
Flow: 1.0 mL/min
Detection: UV at 240 nm
Temperature: 37 °C

Androgens*

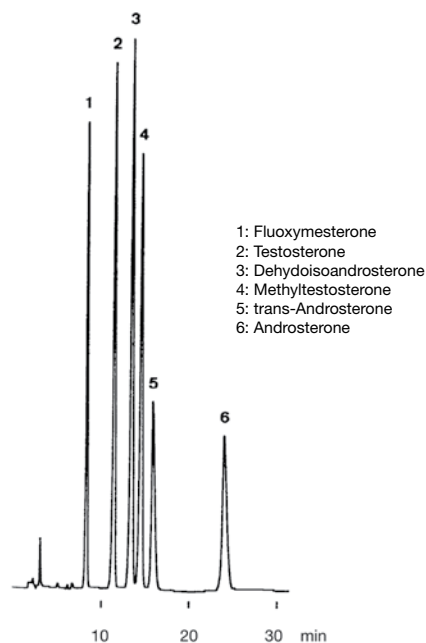

Column: J'sphere ODS-L80 (8 nm, 4 μ m) 150 x 4.6 mm ID
Part No.: JL08S04-1546WT
Eluent: methanol / acetonitrile / water = 45/15/40
Flow: 0.8 mL/min
Detection: UV at 210 nm
Temperature: 30 °C

Ordering Information

YMC Carotenoid

Phase dimension	Column ID [mm]	Column length [mm]					Guard cartridges* with 10 mm length [pack of 5]
		30 (WT) / 33 (QT)	50	100	150	250	
3 µm	2.1	CT99S03-H3Q1QT	CT99S03-05Q1QT	CT99S03-10Q1QT	CT99S03-15Q1QT	CT99S03-25Q1QT	CT99S03-01Q1GC
	3.0	CT99S03-H303QT	CT99S03-0503QT	CT99S03-1003QT	CT99S03-1503QT	CT99S03-2503QT	CT99S03-0103GC
	4.0	CT99S03-H304QT	CT99S03-0504QT	CT99S03-1004QT	CT99S03-1504QT	CT99S03-2504QT	CT99S03-0104GC
	4.6	CT99S03-0346WT	CT99S03-0546WT	CT99S03-1046WT	CT99S03-1546WT	CT99S03-2546WT	CT99S03-0104GC
5 µm	2.1	CT99S05-H3Q1QT	CT99S05-05Q1QT	CT99S05-10Q1QT	CT99S05-15Q1QT	CT99S05-25Q1QT	CT99S05-01Q1GC
	3.0	CT99S05-H303QT	CT99S05-0503QT	CT99S05-1003QT	CT99S05-1503QT	CT99S05-2503QT	CT99S05-0103GC
	4.0	CT99S05-H304QT	CT99S05-0504QT	CT99S05-1004QT	CT99S05-1504QT	CT99S05-2504QT	CT99S05-0104GC
	4.6	CT99S05-0346WT	CT99S05-0546WT	CT99S05-1046WT	CT99S05-1546WT	CT99S05-2546WT	CT99S05-0104GC

*Guard cartridge holder required, part no. XPGCH-Q1

YMC PAH

Phase dimension	Column ID [mm]	Column length [mm]					Guard cartridges* with 10 mm length [pack of 5]
		30 (WT) / 33 (QT)	50	100	150	250	
3 µm	2.1	YP99S03-H3Q1QT	YP99S03-05Q1QT	YP99S03-10Q1QT	YP99S03-15Q1QT	YP99S03-25Q1QT	YP99S03-01Q1GC
	3.0	YP99S03-H303QT	YP99S03-0503QT	YP99S03-1003QT	YP99S03-1503QT	YP99S03-2503QT	YP99S03-0103GC
	4.0	YP99S03-H304QT	YP99S03-0504QT	YP99S03-1004QT	YP99S03-1504QT	YP99S03-2504QT	YP99S03-0104GC
	4.6	YP99S03-0346WT	YP99S03-0546WT	YP99S03-1046WT	YP99S03-1546WT	YP99S03-2546WT	YP99S03-0104GC
5 µm	2.1	YP99S05-H3Q1QT	YP99S05-05Q1QT	YP99S05-10Q1QT	YP99S05-15Q1QT	YP99S05-25Q1QT	YP99S05-01Q1GC
	3.0	YP99S05-H303QT	YP99S05-0503QT	YP99S05-1003QT	YP99S05-1503QT	YP99S05-2503QT	YP99S05-0103GC
	4.0	YP99S05-H304QT	YP99S05-0504QT	YP99S05-1004QT	YP99S05-1504QT	YP99S05-2504QT	YP99S05-0104GC
	4.6	YP99S05-0346WT	YP99S05-0546WT	YP99S05-1046WT	YP99S05-1546WT	YP99S05-2546WT	YP99S05-0104GC

*Guard cartridge holder required, part no. XPGCH-Q1

J'sphere ODS-H80

Phase dimension	Column ID [mm]	Column length [mm]					Guard cartridges* with 10 mm length [pack of 5]
		30 (WT) / 33 (QT)	50	100	150	250	
8 nm 4 µm	2.1	JH08S04-H3Q1QT	JH08S04-05Q1QT	JH08S04-10Q1QT	JH08S04-15Q1QT	JH08S04-25Q1QT	JH08S04-01Q1GC
	3.0	JH08S04-H303QT	JH08S04-0503QT	JH08S04-1003QT	JH08S04-1503QT	JH08S04-2503QT	JH08S04-0103GC
	4.0	JH08S04-H304QT	JH08S04-0504QT	JH08S04-1004QT	JH08S04-1504QT	JH08S04-2504QT	JH08S04-0104GC
	4.6	JH08S04-0346WT	JH08S04-0546WT	JH08S04-1046WT	JH08S04-1546WT	JH08S04-2546WT	JH08S04-0104GC

*Guard cartridge holder required, part no. XPGCH-Q1

J'sphere ODS-M80

Phase dimension	Column ID [mm]	Column length [mm]					Guard cartridges* with 10 mm length [pack of 5]
		30 (WT) / 33 (QT)	50	100	150	250	
8 nm 4 µm	2.1	JM08S04-H3Q1QT	JM08S04-05Q1QT	JM08S04-10Q1QT	JM08S04-15Q1QT	JM08S04-25Q1QT	JM08S04-01Q1GC
	3.0	JM08S04-H303QT	JM08S04-0503QT	JM08S04-1003QT	JM08S04-1503QT	JM08S04-2503QT	JM08S04-0103GC
	4.0	JM08S04-H304QT	JM08S04-0504QT	JM08S04-1004QT	JM08S04-1504QT	JM08S04-2504QT	JM08S04-0104GC
	4.6	JM08S04-0346WT	JM08S04-0546WT	JM08S04-1046WT	JM08S04-1546WT	JM08S04-2546WT	JM08S04-0104GC

*Guard cartridge holder required, part no. XPGCH-Q1

J'sphere ODS-L80

Phase dimension	Column ID [mm]	Column length [mm]					Guard cartridges* with 10 mm length [pack of 5]
		30 (WT) / 33 (QT)	50	100	150	250	
8 nm 4 µm	2.1	JL08S04-H3Q1QT	JL08S04-05Q1QT	JL08S04-10Q1QT	JL08S04-15Q1QT	JL08S04-25Q1QT	JL08S04-01Q1GC
	3.0	JL08S04-H303QT	JL08S04-0503QT	JL08S04-1003QT	JL08S04-1503QT	JL08S04-2503QT	JL08S04-0103GC
	4.0	JL08S04-H304QT	JL08S04-0504QT	JL08S04-1004QT	JL08S04-1504QT	JL08S04-2504QT	JL08S04-0104GC
	4.6	JL08S04-0346WT	JL08S04-0546WT	JL08S04-1046WT	JL08S04-1546WT	JL08S04-2546WT	JL08S04-0104GC

*Guard cartridge holder required, part no. XPGCH-Q1

For other dimensions please refer to page 352-353





Flash Cartridges

Contents

Advantages	298
Application / Product Finder.....	299
Ordering Information.....	300

Introduction

Flash Cartridges

Traditionally, irregular shaped silica, typically with particles sizes of 40-63 μm , has been successfully used for sample clean-up and fast workup after chemical synthesis. Also, this type of silica represents cost-effective media, yet with ever improved reproducibility, for standard applications.

Applying spherical silica will greatly enhance resolution - in less time, for more challenging demands. Spherical silica generates substantially less back pressure so that increased flow rates can be applied.

Flash Cartridges

YMC-DispoPackAT Flash Cartridges - high quality products for your purification success

YMC-DispoPackAT cartridges are available in different volumes taking from 12 g to 800 g of packing material. The product finder on the next page provides indicative data on how to choose a cartridge size, depending on sample volume. Apart from straight silica, the following standard bonding options are available: NH₂ (Amino), Diol and ODS (C18).

In order to verify the efficiency or to compare the differences, please request evaluation samples from YMC or authorized YMC Distributors.



Main advantages:

- Compatible with all common Flash Systems (e.g. ISCO, Interchim, Agilent, Grace, Büchi ...)
- Fast and easy installation using Luer/Luer-Lock-connectors
- Using 25 µm material: 50% time saving through high resolution at high flow-conditions
- High reproducibility

Flash Cartridges	Traditional	Premium
Shape	irregular	spherical
Base	silica	silica
Particle size / µm	40-63	25
Pore size / nm	SIL 6; NH ₂ , Diol, ODS 15	8
Column connection	Luer / Luer lock	Luer / Luer lock
Pressure tolerance	13.8 bar (300 g & 800 g 12.4 bar)	13.8 bar (300 g & 800 g 12.4 bar)
Available bondings	SIL, NH ₂ , Diol, ODS	SIL, NH ₂ , Diol, ODS
Available sizes / g	12, 40, 120, 300, 800	12, 40, 120, 300, 800

50% time saving*

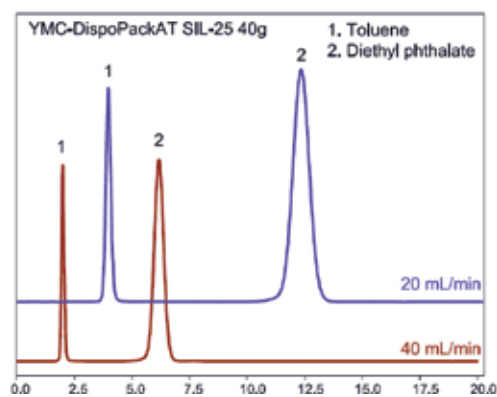

Eluent: n-hexane / ethyl acetate (90/10)
Detection: UV at 254 nm

High reproducibility*

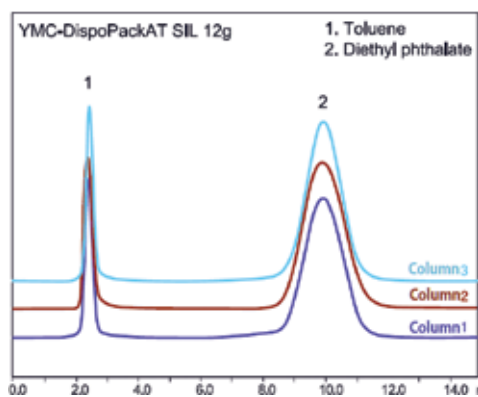

Eluent: n-hexane / ethyl acetate (90/10)
Flow rate: 10 mL/min
Detection: UV at 254 nm

Flash Cartridges

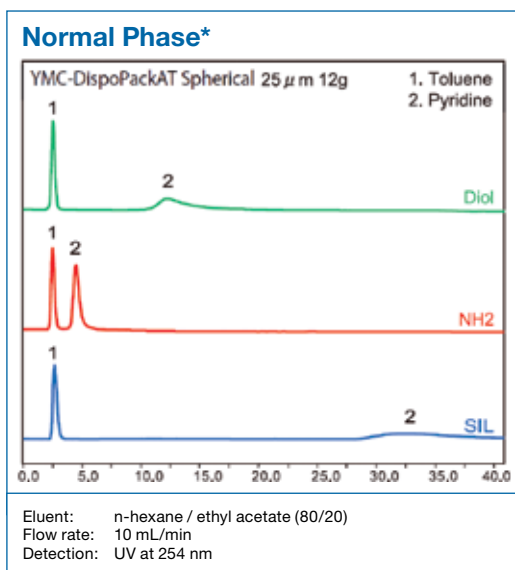

Application Examples Normal Phase:

e.g. carotenoids, phthalates, phenones, steroids ...

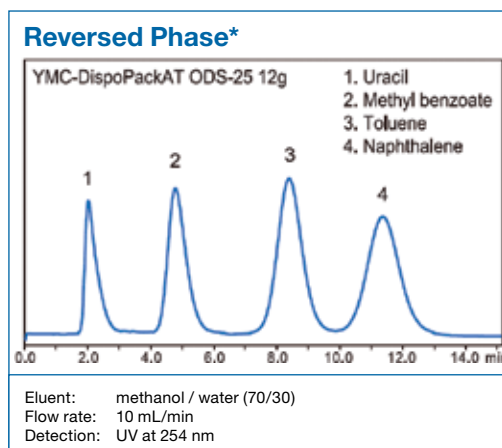

Application Examples Reversed Phase:

e.g. polar organic compounds, polar heterocyclic compounds, peptides

Product Finder

The table on page 300 will help you choose the appropriate flash cartridge for your application. You only need to decide on the particle size and shape and the desired bonding. Calculation of appropriate cartridge size? Subtraction of the reciprocal retention factors yields the ΔCV -value. You can find the most appropriate cartridge size by checking the diagram with the ΔCV -value and the sample size you like to purify.

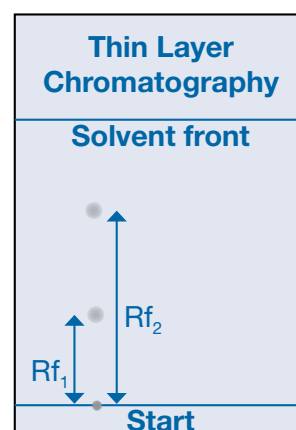
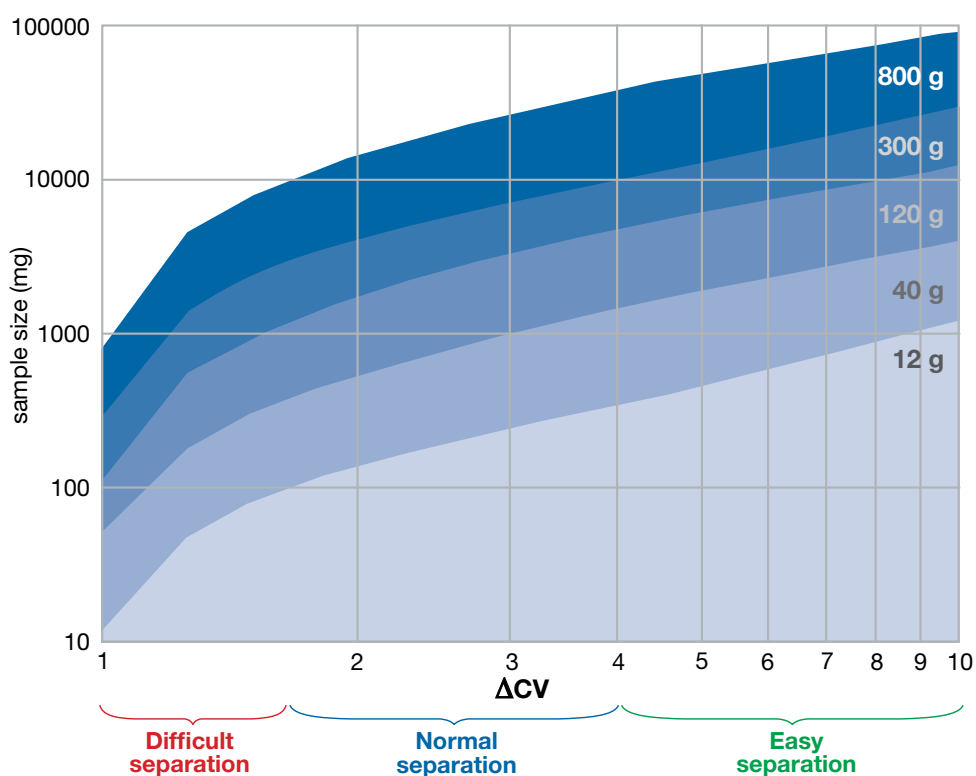

RF: Retention Factor

CV: Column Volume

$CV = 1/RF$

$\Delta CV = 1/RF_1 - 1/RF_2$

Ordering Information

Traditional: Irregular (Particle Size 40 – 63 µm)

Product	Size [g]	Pack Qty	Part number
YMC-DispoPackAT SIL	12	24	DPA12SLK06I5224
	40	12	DPA40SLK06I5212
	120	6	DPAA2SLK06I5206
	300	1	DPAC0SLK06I5201
	800	1	DPAH0SLK06I5201
YMC-DispoPackAT NH₂	12	24	DPA12NHK15I5224
	40	12	DPA40NHK15I5212
	120	6	DPAA2NHK15I5206
	300	1	DPAC0NHK15I5201
	800	1	DPAH0NHK15I5201
YMC-DispoPackAT Diol	12	24	DPA12DLK15I5224
	40	12	DPA40DLK15I5212
	120	6	DPAA2DLK15I5206
	300	1	DPAC0DLK15I5201
	800	1	DPAH0DLK15I5201
YMC-DispoPackAT ODS	12	24	DPA12ABK15I5224
	40	12	DPA40ABK15I5212
	120	6	DPAA2ABK15I5206
	300	1	DPAC0ABK15I5201
	800	1	DPAH0ABK15I5201

Premium: Spherical (Particle Size 25 µm)

Product	Size [g]	Pack Qty	Part number
YMC-DispoPackAT SIL-25	12	24	DPA12SLK08S2524
	40	12	DPA40SLK08S2512
	120	6	DPAA2SLK08S2506
	300	1	DPAC0SLK08S2501
	800	1	DPAH0SLK08S2501
YMC-DispoPackAT NH₂-25	12	24	DPA12NHK08S2524
	40	12	DPA40NHK08S2512
	120	6	DPAA2NHK08S2506
	300	1	DPAC0NHK08S2501
	800	1	DPAH0NHK08S2501
YMC-DispoPackAT Diol-25	12	24	DPA12DLK08S2524
	40	12	DPA40DLK08S2512
	120	6	DPAA2DLK08S2506
	300	1	DPAC0DLK08S2501
	800	1	DPAH0DLK08S2501
YMC-DispoPackAT ODS-25	12	24	DPA12ABK08S2524
	40	12	DPA40ABK08S2512
	120	6	DPAA2ABK08S2506
	300	1	DPAC0ABK08S2501
	800	1	DPAH0ABK08S2501



Preparative & Process LC

Contents

General	304-305
YMC-Triart Prep	306-310
Ordering Information	311
YMC*Gel HG-Series	312-315
Available Products	316-317
 YMC-BioPro (IEX)	318-321
Ordering Information	322

Introduction

YMC is one of the very few global players in the market that meet the challenging demands in preparative scale chromatography. Our ambition is to provide chromatographic solutions for any compound from its discovery through scale-up to production and its quality control in the lab, as well as positive, active support, chromatographic tools and technical assistance at every stage.

Preparative & Process LC

In order to optimise preparative processes the employed bulk needs to provide:

- optimised selectivity → maximum output per run
- mechanical stability → cost efficiency
- reproducibility → reliability



YMC of today maintains three technology platforms:

- chemically re-enforced pH-stable YMC-Triart with C18, C8 and customised (e.g. quarternary ammonium) surface chemistries
- high grade silica phases for preparative HPLC with improved mechanical stability, including polysaccharide phases for chiral applications (see page 312-317)
- high resolution IEX prep media in 10, 30, and 75 μm particle sizes with an annual capacity beyond 20,000 litres



Preparative & Process LC



All the above platforms are available not only as preparative grades by definition of the specification, but also by availability in multi-ton per year capacities, and large lot sizes.



In addition to product supply, YMC is proud to be recognised for outstanding technical support by dedicated people with a mission to exceed expectations. YMC will happily share expertise and proactively contribute to make customers successful in their daily work. YMC support teams are located in Japan, China, Korea, Taiwan, Singapore, India and the USA in addition to Germany which provides support for the EMEA countries together with a network of authorised distributors who supply additional local support.

YMC-Triart Prep

- extended pH range
- mechanical stability
- high loadability
- CIP with NaOH solutions applicable
- up to 4-fold longer lifetimes
- multi-ton capacity

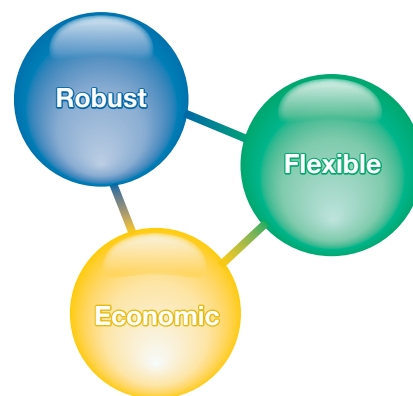

Specifications	YMC-Triart Prep C18-S	YMC-Triart Prep C8-S
Base material	inorganic/organic hybrid	
Particle size / μm	10, 15, 20	10, 15, 20
Pore size / nm	12	20
Surface area / m^2g^{-1}	360	220
Bonding	trifunctional	trifunctional
End-capping	yes	yes
Flexible pH range	2.0 ~ 10.0	2.0 ~ 10.0

General

YMC-Triart Prep is chemically stable up to pH 10.0. This provides more flexibility for method development and allows for more efficient cleaning-in-place (CIP) procedures. From real life process development work YMC-Triart Prep has been shown to outperform traditional silica-based materials 2- to 4-fold in terms of stability. Longer column lifetimes lead to more kilogram of product produced per kilogram of stationary phase.

Why not choose the better media?

Particle technology

YMC-Triart Prep materials provide improved particle and pore size distributions which result in reduction of backpressures and increased sample loadabilities are achieved during preparative operation.

With YMC-Triart Prep previously challenging pH and high temperature conditions can be used for demanding applications even in the day-to-day work in laboratories or production. Most importantly, due to its unique particle composition, a balanced hydrophobicity and silanol activity is achieved which makes YMC-Triart Prep a "First Choice" material in method development!

Homogeneous and uniform particles



YMC-Triart (12 nm, 5 μm)



YMC-Triart Prep (20 nm, 15 μm)



X-Bridge HILIC (13.5 nm, 5 μm)

by courtesy of YMC Co., Ltd.

YMC-Triart Prep

Excellent pH stability

Acidic condition (pH 1, 70 °C)*

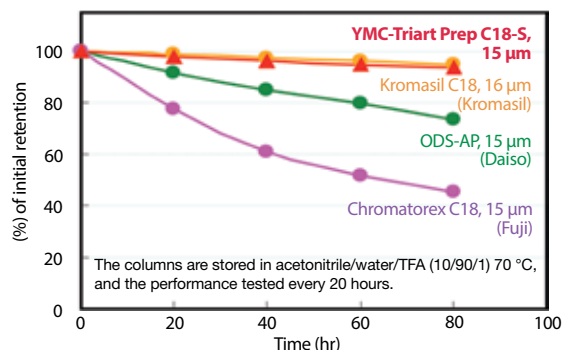

Column: 250 x 6.0 mm ID
 Eluent: acetonitrile / water (60/40)
 Flow rate: 1.7 mL/min
 Temperature: 37 °C
 Detection: UV at 254 nm
 Sample: butyl benzoate

Alkaline condition (pH 11.5, 50 °C)*

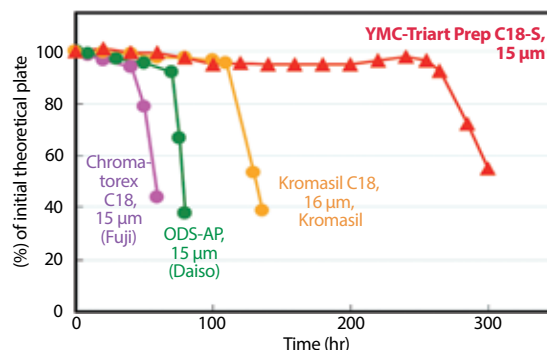

Column: 150 x 4.6 mm ID
 Eluent: 50 mM TEA in methanol /
 50 mM TEA in water (pH 11.5) (20/80, v/v)
 Flow rate: 1.0 mL/min
 Detection: UV at 254 nm
 Sample: caffeine

At high pH YMC-Triart Prep C18-S shows lifetimes of up to 4 times longer compared to conventional silica materials. This enables new separations to be carried out at high pH which are not possible with silica materials. Furthermore, the material can endure more CIP-cycles than conventional phases used in industrial processes.

Advantages of YMC-Triart Prep

YMC-Triart Prep	Your benefit
pH-stability 2.0 ~ 10.0	More stable to CIP-conditions Method development
Chemical and mechanical stability	Cost savings High production throughput Increased lifetimes
Uniform particle size	Improved packing = improved chromatographic performance = reduced backpressure
Narrow pore size distribution	High loadability
100% aqueous conditions	Separation of polar substances Method development

This makes YMC-Triart Prep “first choice” material for method development and process optimisation!

YMC-Triart Prep

Mechanical stability

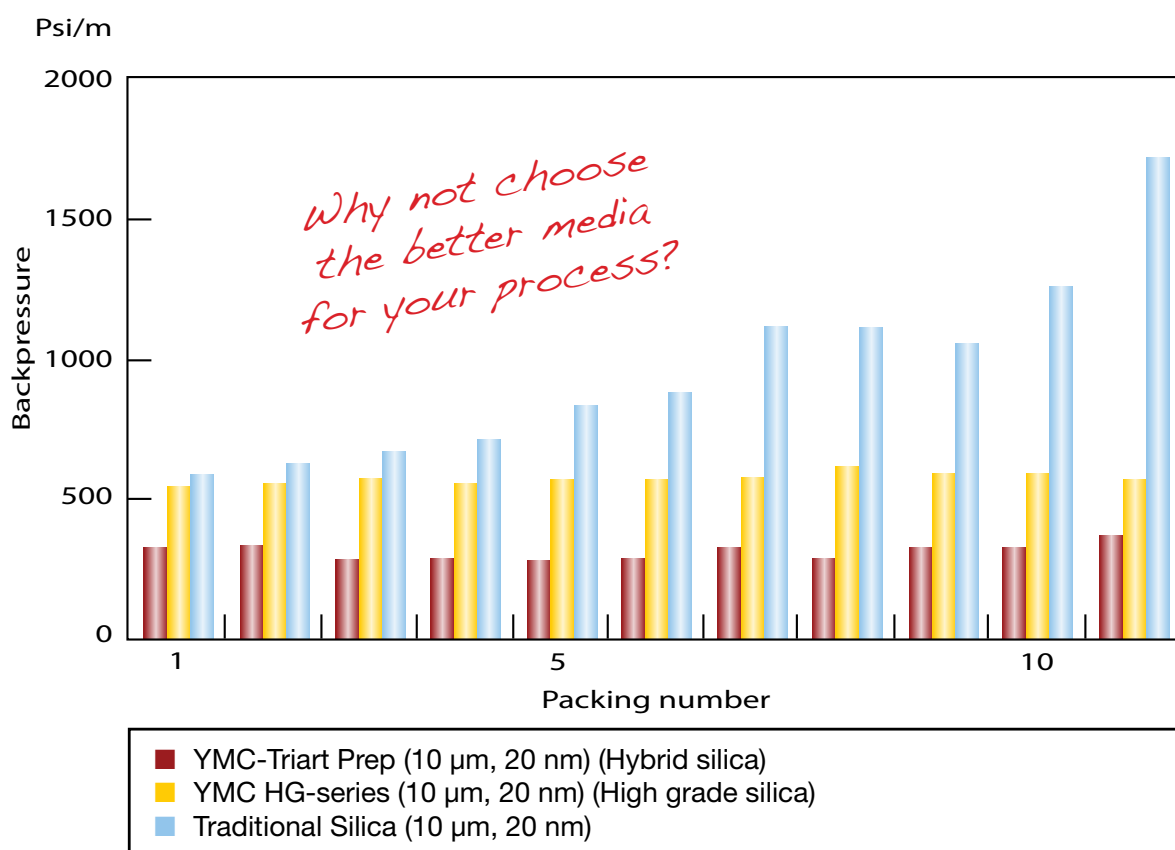
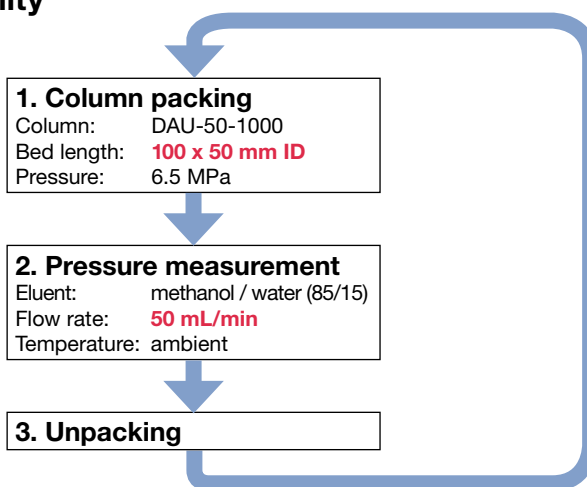

Shearing and crushing of silica particles leads to the formation of fines, which results in an increased backpressure. By using mechanically stable, spherical particles the formation of fines can be reduced.

Here, high mechanical stability of YMC-Triart Prep is demonstrated by means of repeated packing of a DAC column. Even after more than 10 repacking cycles using the same material the pressure does not increase. The absence of fines is demonstrated by a constant backpressure.

YMC-Triart Prep

YMC Triart Prep C18-S vs. competitor material (client data)

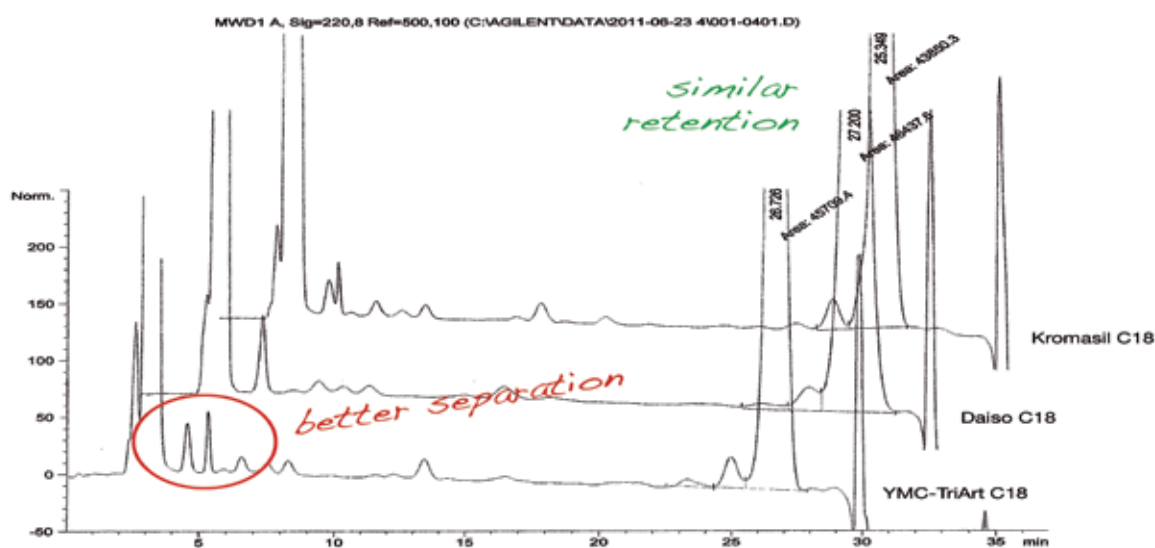

Client data confirms that YMC-Triart Prep C18-S shows retention for hydrophobic compounds comparable to conventional silica materials. At the same time polar molecules are exceptionally well separated.

Client data shows non-optimized scouting runs performed on the respective C18 material packed into 250 x 4.6 mm ID columns.

Narrow pore distribution*

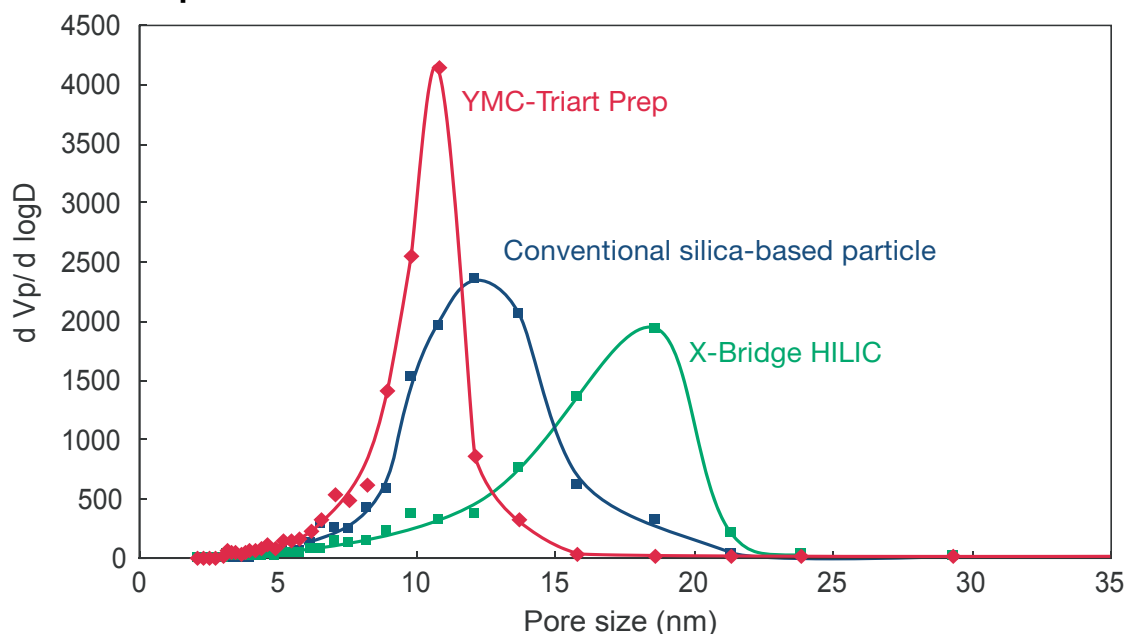

A narrow pore size distribution of a stationary phase beneficially affects peak width and sample loading in liquid chromatography. YMC-Triart Prep C18-S exhibits a narrower pore size distribution. This results in improved peak shapes and higher sample loading in your preparative processes.

YMC-Triart Prep

CIP performance of YMC-Triart Prep C8-S

YMC-Triart Prep C8-S (10 μ m, 20 nm)*

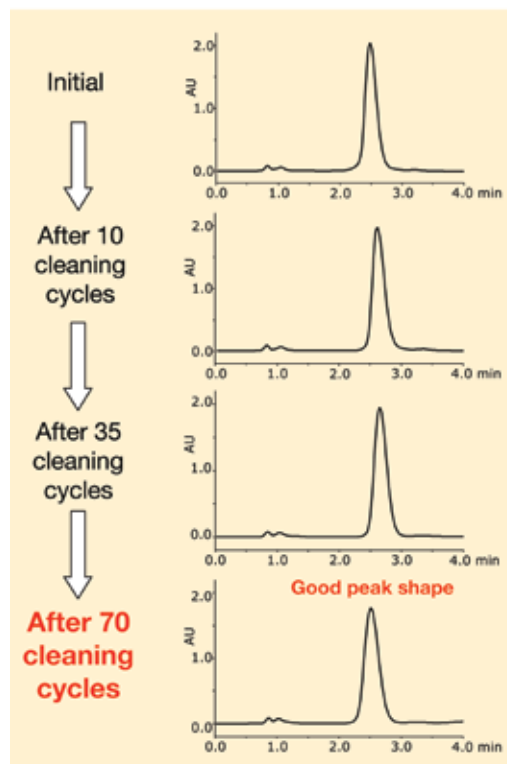

Silica based C8 material (10 μ m, 20 nm)*

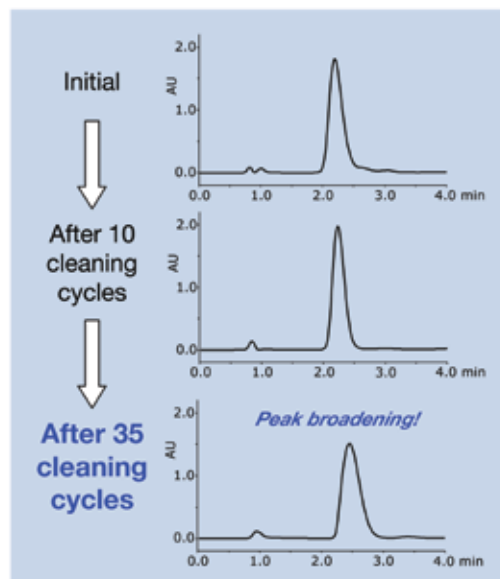

**Column lifetime
extended
by factor > 2**

Column:	50 x 4.6 mm ID
Eluent:	A) water / TFA (100/0.1) B) acetonitrile / TFA (100/0.1) 29-36% B (0-2 min), 36% B (2-3 min), 29% B (3-6 min)
Flow rate:	1.0 mL/min
Temperature:	25 °C
Detection:	UV at 220 nm
Injection:	6 μ L
Sample:	10 mg/mL insulin bovine + human serum (2:1)

In insulin production repeated injections of a solution of insulin in human plasma/serum are carried out. Consequently, absorption of impurities on the surface of the packing material reduces the retention capacity of the column.

Methodology: At this point a wash step with an alkaline solution (e.g. 0.1 M NaOH) removes the impurities and restores the full capacity of the column.

Problem: Silica materials are unsuitable for alkaline wash conditions, because of their limited stability at high pH.

Solution: Hybrid silica-based YMC-Triart Prep has an excellent stability at high pH. It is amenable to alkaline wash conditions and longer column lifetime.

This in turn reduces production costs: Lower consumption of packing material and less downtimes due to column repacking. An extension of column lifetime by a factor of more than two has been achieved!

Ordering information

YMC-Triart Prep C18-S			YMC-Triart Prep C8-S		
Pore size (nm)	Particle size (µm)	Product Code	Pore size (nm)	Particle size (µm)	Product Code
12	10	TAS12S11	20	10	TOS20S11
	15	TAS12S16		15	TOS20S16
	20	TAS12S21		20	TOS20S21

Typical pack sizes:

Laboratory scale: 100 g - 5 kg PE bottle

Industrial scale: 5 kg - 50 kg in double lined
PE bags inside metal drum

Larger pack sizes on request

Regulatory support file available under non-disclosure agreement.
Used in validated cGMP-manufacturing processes.

Other particle and pore size combinations on request.

Examples of existing customised material:
TAS08S11, TOS12S11, TOS12S16, TQP12S21

Customised material available on request.
DMF registered with FDA.

YMC*Gel HG-Series

- Higher sample load
- Lower backpressure
- Longer column usage
- More repackings possible
- More efficient column packing



General

YMC has more than 30 years experience in the manufacture of silica-based stationary phases for high pressure liquid chromatography (HPLC).

The substantial investment into facilities and staff represent YMC's ongoing commitment towards high quality products and technical support. The company's state-of-the-art silica production facilities allow for large batches of more than 500 kg/lot. Our large-scale bonding site has allowed lots of over 200 kg of bonded silica to become routine operations.

Besides innovations in the field of hybrid silica (YMC-Triart) and polymeric ion-exchange resins (YMC-BioPro) YMC dedicated considerable effort into improving chromatographic properties of silica based materials.

Availability

YMC provides an extensive selection of more than 20 fully scalable stationary phases from 1.9 to 50 μm in various pore sizes and specifications to address virtually any separation need. In addition, YMC can also custom manufacture products with specific properties, e.g. defined pore size and/or carbon content, to provide optimal suitability to individual separations. This unique choice of selectivities meets the highest demand in conventional column separations and also dynamic axial or dynamic radial compression columns and simulated moving bed (SMB) techniques.

Bulk Packing Material

Preparative and process scale YMC bulk packing materials (10 to 50 μm) can be obtained in gram to multi-ton scale quantities. YMC's advanced production facilities are able to manufacture multi-ton quantities of silica per annum, with large batches in excess of 500 kg/lot. YMC's large-scale bonding plants have a capacity of more than 200 kg/lot.

Long Term Supply

In order to meet increasing demands in analytical and preparative chromatography, chromatographers highly depend on a reliable source of supply throughout a validated method. Therefore, YMC will never knowingly change or modify an existing product which has any such customer base. Any product improvements will result in an entirely new YMC product.

World Wide Availability

Pre-packed columns and bulk materials are available worldwide through a dedicated support network headed by YMC operations in Japan, the US and in Europe to ensure facile method transfer between research and production sites across the world.

YMC*Gel HG-Series

Improved silica base for better performance

Improvements in the production process of the base silica yield particles with higher mechanical stability and more uniform particle and pore size distribution.

SEM image

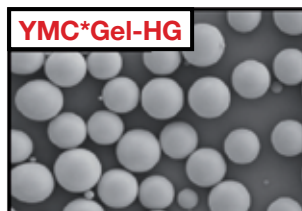
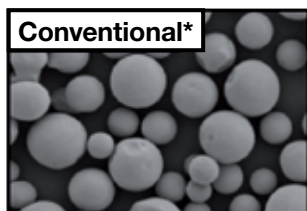

Reduced backpressure and improved chromatographic efficiency due to more uniform particle size distribution.

Optical microscope image

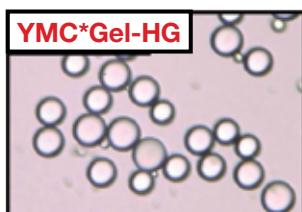
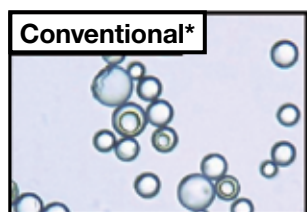

Better column packing efficiency and less fines due to reduction of "balloon particles".

* for illustration purposes a section highlighting chipped particles and balloon particles was chosen.

Improvement	Customer advantage
Improved morphology and mechanical stability	<p>Higher productivity due to longer usage of bulk material</p> <p>Less fines</p> <p>Reduced backpressure</p> <p>More repackings possible</p>
Narrower particle size distribution	<p>Reduced backpressure</p> <p>Increased productivity due to higher flowrates at constant pressure</p> <p>More efficient columns due to faster column packing</p>
Narrower pore size distribution	<p>Higher (over-) loading capacity</p> <p>Increased productivity</p>

YMC*Gel HighGrade (HG)-series

Go for the better!

YMC*Gel HG-Series

Discover optimum selectivity with YMC*Gel HG-series silica products

The basis for every successful separation is the selection of the appropriate stationary phase. YMC offers one of the world's largest portfolios of selectivities, designed to handle even the most demanding separations.

Your benefits:

- 10 preparative phase chemistries → solving virtually any separation need
- full scalability
- pore sizes from 8 to 30 nm
- particle sizes from 10 to 50 µm
- customised bulk properties (pore size, carbon content, endcapping)

The retention characteristics of a selection of YMC's preparative selectivities are shown in the chromatograms below. Conditions were selected to simulate a broad application range on both basic and acidic compounds.

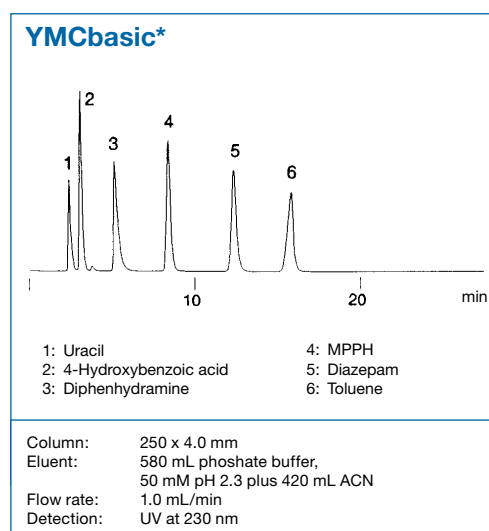
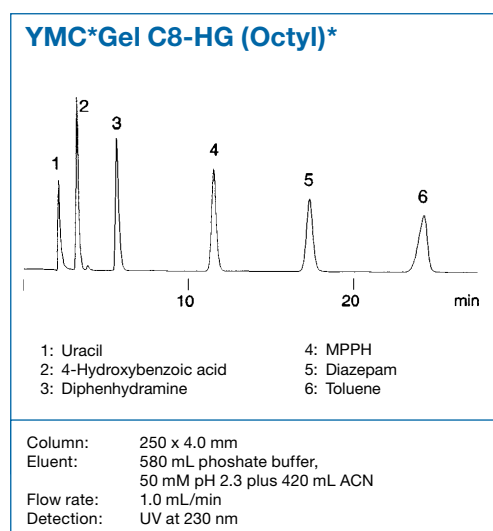
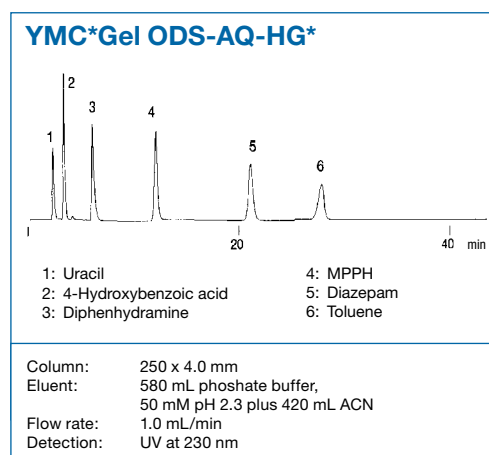
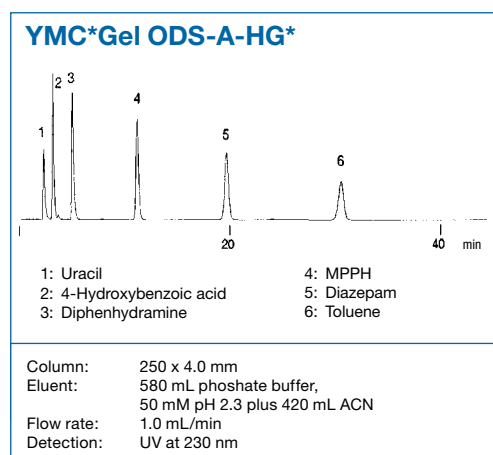

YMC*Gel HG-Series

Impact of Pore Size Differences*

YMC*Gel is available in a variety of different pore sizes. Pore sizes are usually matched to sample molecule sizes. Pore sizes can also be used to adjust ligand density and hence retention characteristics of a bonded phase, since the size of the pores also affects the total media surface area in a packed column.

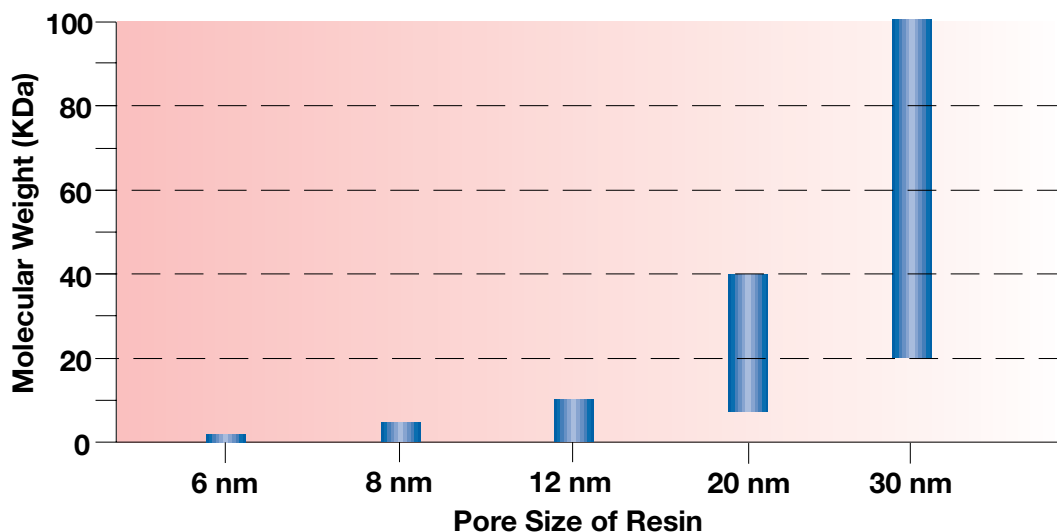

Please note extended molecular weight range when applying SEC.

Pore Size [nm]	Surface Area [m ² /g]	Recommendation
12	330	Suitable for the majority of separations For most organic compounds For peptides less than 20 kDa Higher surface area and sample loading than 20 nm and 30 nm media
20	175	For peptides and smaller proteins from 10 kDa to 50 kDa For bulky organic compounds Higher surface area and higher sample loading than 30 nm media
30	100	For large proteins and biomolecules larger than 40 kDa For organic compounds with excessive retention on smaller pore materials

Further pore sizes available on request.

Available YMC*Gel HG-series products

PRODUCT	PHASE CODE	BONDING	PHASE DESCRIPTION
ODS-A-HG	AAG	C18	high performance C18 silica
ODS-AQ-HG	AQG	C18	“hydrophilic” endcapping, for 100% aqueous eluent systems, substantially increased retention of polar compounds
C8-HG (Octyl)	OCG	C8	C8 phase, high coverage monomeric bonding chemistry
C4-HG (Butyl)	BUG	C4	C4 phase, less hydrophobic surface structure than C8 packing material
TMS-HG (C1)	TMG	C1	trimethylsilane bonding, excellent hydrolytic stability
Ph-HG (Phenyl)	PHG	Phenyl	monomeric bonded phenyl, the π electron interaction gives a separation selectivity different from ODS
NH ₂ -HG (Amino)	NHG	Aminopropyl	primary amino derivative, high coverage monomeric bonding chemistry, suitable for HILIC
CN-HG (Cyano)	CNG	Cyanopropyl	for RP and NP applications, useful also for SFC and HILIC
Diol-HG	DLG	Diol	for normal phase applications, high recovery for biological material, suitable for HILIC and SFC
SIL-HG (Silica)	SLG	—	ultra high purity, high mechanical stability, suitable for HILIC and SFC

Available products with customer base

PRODUCT	PHASE CODE	BONDING	PHASE DESCRIPTION
YMCbasic	BA	C8	specifically designed for the separation of basic compounds and peptides
YMC Omega	OMG	proprietary	specifically designed for the separation of polyunsaturated fatty acids

Analytical grades (3 and 5 μ m) are routinely available in pre-packed columns. Particle sizes as indicated.

If not listed, please ask for quotation.

Multi ton capacity. Customised packing materials available on request. Pore sizes in parenthesis on request.

*Not all combinations available.

**With respect to pore size.

Available YMC*Gel HG-series products

PORE SIZE* (nm)	PARTICLE SIZE* (µm)	CARBON LOAD** (%C)	pH	TYPICAL APPLICATIONS
12; 20; 30	10; 15; 20; 50	17; 12; 7	2.0-7.5	pharmaceuticals, vitamins, peptides, PTC-amino acids, general purpose phase
8; 12; 20	10; 15; 20; 50	15; 14; 10	2.0-7.5	strong polar compounds, pharmaceuticals, antibiotics, peptides and proteins, nucleic acids, amino acids and nucleotides
12; 20; 30	10; 15; 20; 50	10; 7; 4	2.0-7.5	proteins and peptides, estrogens, general purpose phase
12; 20; 30	10; 15; 20; 50	7; 5; 3	2.0-7.5	biological separations, polar compounds, proteins
12; (20; 30)	10; 15; 20; 50	4	2.0-7.5	water-soluble vitamins
12; (20; 30)	10; 15; 20; 50	9	2.0-7.5	phenols, fullerenes, sweeteners, aromatics
12; (20; 30)	10; 15; 20; 50	3	2.0-7.5	saccharides, nucleotides, water-soluble vitamins
12; (20; 30)	10; 15; 20; 50	7	2.0-7.5	proteins, steroids, catechols, for SFC applications
12; 20; 30	10; 15; 20; 50	–	2.0-7.5	polar natural products, pharmaceuticals, for HILIC and SFC applications
12; 20; 30	10; 15; 20; 50	–	–	small organic molecules, fat-soluble vitamins, tocopherols, steroids

Available products with customer base

PORE SIZE* (nm)	PARTICLE SIZE* (µm)	CARBON LOAD** (%C)	pH	TYPICAL APPLICATIONS
20	10; 15; 20	7	2.0-7.5	basic molecules w/o modifiers, peptides
proprietary	10; 20; 50	15	2.0-7.5	polyunsaturated fatty acids, EPA, DHA

Regulatory support file available under non-disclosure agreement. Used in validated cGMP-manufacturing processes.

Customised material available on request. DMF registered with FDA.

YMC-BioPro - IEX Ion Exchange Media

- high dynamic binding capacity
- low non-specific adsorption
- excellent recovery
- easy removal
- cleaning-in-place with NaOH solutions applicable



YMC-BioPro

Ion exchange chromatography (IEX) is widely used in the analysis and purification of bio-molecules. Using reversible charge-charge interactions offers several advantages in comparison to other chromatographic methods, e.g. high capacity and fast throughput. Therefore, IEX is often used in the capture or intermediate purification of bio-molecules.

YMC-BioPro is a series of ion exchange resins specifically designed for use in bio-chromatography. This media is based on a hydrophilic polymer matrix, with a particle size of 10 μm , 30 μm or 75 μm . It is available as a strong anion exchanger (YMC-BioPro QA) or a strong cation exchanger (YMC-BioPro SP). YMC-BioPro offers a high dynamic binding capacity (DBC), together with low non-specific adsorption and excellent recovery.

Currently, YMC-BioPro is manufactured in lot sizes up to 200 L. In future, lot sizes up to 1,200 L will be available.

Examples of possible preparative applications of YMC-BioPro resins:

Antibody purification	Protein purification	Peptide purification
Trastuzumab Becacizumab IgG, Antibody variants	Histones Interferon Factor VIII, Factor IX	Insulin

Particle technology

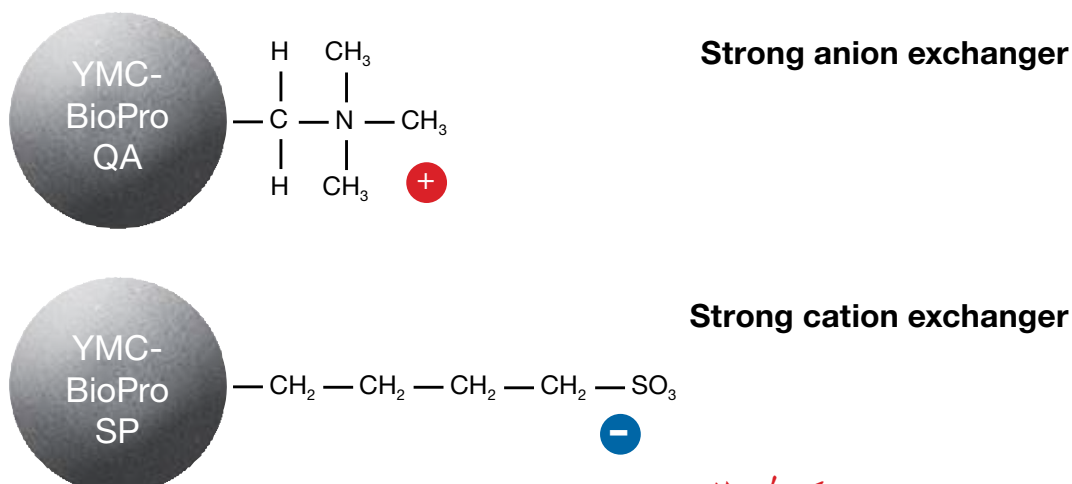

N.B.: Fully porous particles

YMC-BioPro - IEX Ion Exchange Media

Specification



	SmartSep		Capture	SmartSep		Capture
YMC-BioPro Series	YMC-BioPro SmartSep Q10	YMC-BioPro SmartSep Q30	YMC-BioPro Q75	YMC-BioPro SmartSep S10	YMC-BioPro SmartSep S30	YMC-BioPro S75
Ion exchange type	strong anion exchanger			strong cation exchanger		
Charged group	-R-N+(CH ₃) ₃			-R-SO ₃		
Matrix	Hydrophilic polymer beads					
Pore size	Porous					
Compression factor	1.1 - 1.4					
pH-range	2.0 - 12.0					
Particle size	10 µm	30 µm	75 µm	10 µm	30 µm	75 µm
Pressure resistance	Regular use: 3 MPa Max.: 4 MPa	Regular use: 2 MPa Max.: 3 MPa	0.3 MPa	Regular use: 3 MPa Max.: 4 MPa	Regular use: 2 MPa Max.: 3 MPa	0.3 MPa
Ion-exchange capacity	min. 0.08 meq/mL-resin		min. 0.10 meq/mL-resin	min. 0.08 meq/mL-resin		min. 0.10 meq/mL-resin
Dynamic binding capacity	min. 100 mg/mL-resin (BSA)		min. 160 mg/mL-resin (BSA)	min. 100 mg/mL-resin (lysozyme)		min. 160 mg/mL-resin (lysozyme)

Regulatory support file available under non-disclosure agreement. Used in validated cGMP-manufacturing processes.

Customised material available on request. DMF registered with FDA.

Advantages of YMC-BioPro

YMC-BioPro features	Your benefit
Excellent flow properties	Low backpressure High production throughput
Highly uniform particle and pore size distribution	Easy and efficient column packing Improved chromatographic performance
pH stability	Stable towards CIP-conditions Flexibility in method development
High dynamic binding capacity at high flow rates	High loadability Process more raw material
Flexible production capacities	Column filling from a single lot
Economic resin	Cost effective

YMC-BioPro - IEX Ion Exchange Media

Excellent DBC at high linear flow rates*

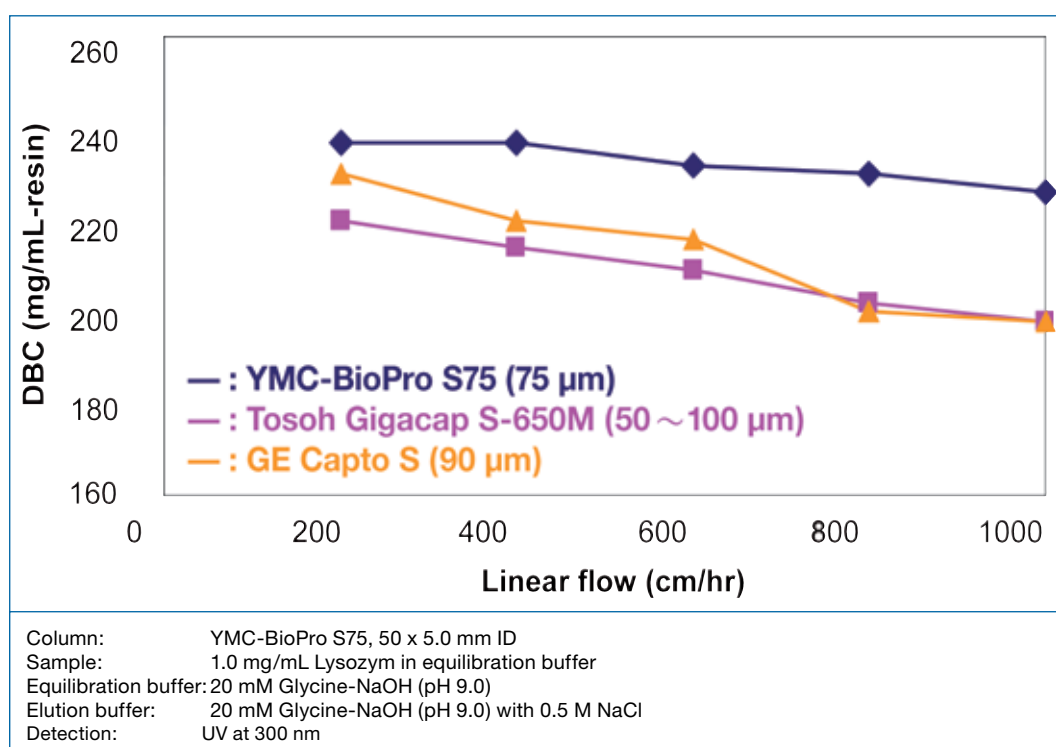
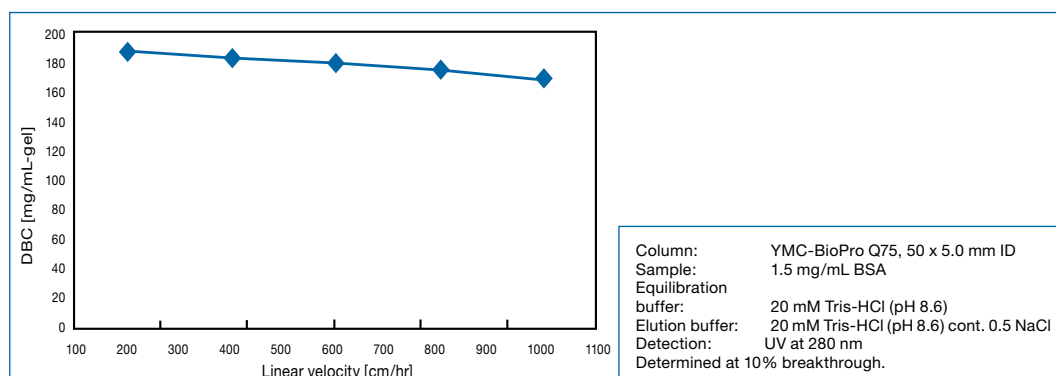

High sample loading at high flow rates is determined by the dynamic binding capacity of an ion exchange resin.

The dynamic binding capacity of YMC-BioPro is excellent even at high flow rates. When compared to similar competitor products it consistently exhibits a higher dynamic binding capacity. This results in higher sample loading in your preparative processes.

YMC-BioPro - IEX Ion Exchange Media

Cleaning-in-place (CIP) performance of YMC-BioPro

Test protocol

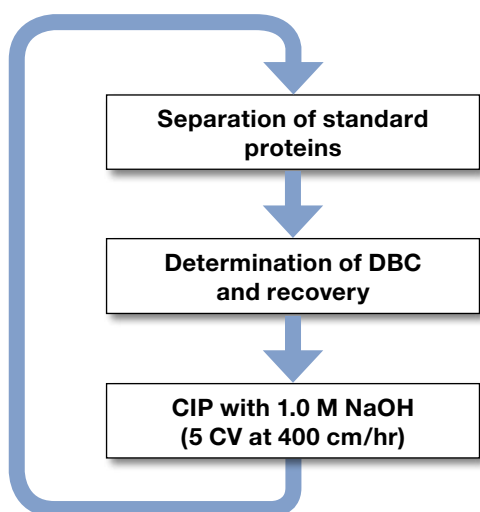

Column: YMC-BioPro S75, 50 x 5.0 mm ID

Conditions of standard protein separation

Eluent: A) 20 mM NaH₂PO₄-Na₂HPO₄ (pH 6.8)
B) 20 mM NaH₂PO₄-Na₂HPO₄ (pH 6.8) containing 0.5 M NaCl

Gradient: 0-100% B (0-60 min, Linear)
Flow rate: 0.59 mL/min (180 cm/hr)
Temperature: 25 °C
Detection: UV at 220 nm
Injection: 24 µL

Conditions of DBC determination

Equilibration buffer: 20 mM Glycine-NaOH (pH 9.0)
Elution buffer: 0.5 M NaCl in equilibration buffer
Flow rate: 2.62 mL/min (800 cm/hr)
Sample: 1.0 mg/mL Lysozyme in equilibration buffer
Temperature: ambient (25 °C)
Detection: UV at 300 nm
DBC is determined at 10% breakthrough.

CIP performance of YMC-BioPro

Separation of standard proteins*

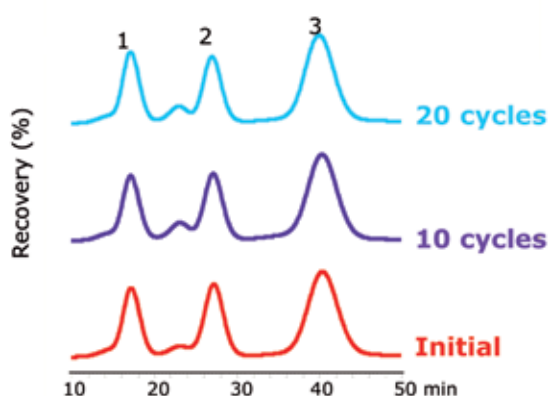

DBC and recovery*

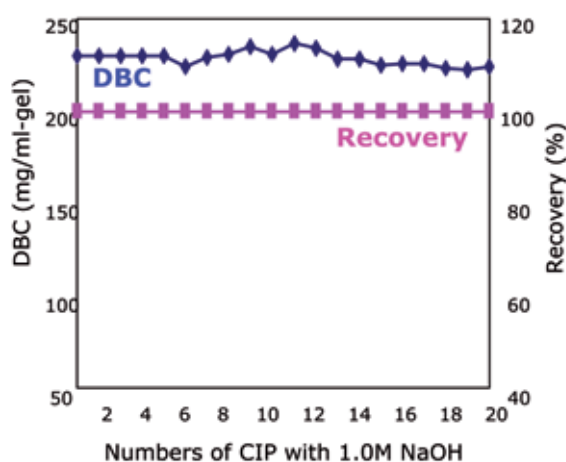

YMC-BioPro is well suited for alkaline CIP procedures.

The dynamic binding capacity (DBC) and the selectivity are unaffected by 20 cycles of CIP with 1.0 M NaOH. The recovery of proteins is maintained at 100%, which demonstrates the absence of nonspecific adsorption of proteins of this hydrophilic resin.

Ordering Information

Strong anion exchanger YMC-BioPro Q

Product	Particle Size	Code	Pack Sizes*				
			50 mL	250 mL	1 L	5 L	25 L
BioPro SmartSep Q10	10 µm	QSA0S10	✓	✓	✓	✓	✓
BioPro SmartSep Q30**	30 µm	QSA0S30	✓	✓	✓	✓	✓
YMC-BioPro Q75	75 µm	QAA0S75	✓	✓	✓	✓	✓

Strong cation exchanger YMC-BioPro S

Product	Particle Size	Code	Pack Sizes*				
			50 mL	250 mL	1 L	5 L	25 L
BioPro SmartSep S10	10 µm	SSA0S10	✓	✓	✓	✓	✓
BioPro SmartSep S30**	30 µm	SSA0S30	✓	✓	✓	✓	✓
YMC-BioPro S75	75 µm	SPA0S75	✓	✓	✓	✓	✓

* Larger or customised pack sizes are available on request.

** Conventional YMC-BioPro Q30/S30 (QAA0S30/SPA0S30) available on request.





Technical Information

Contents

Column Handling	326-328
Mobile Phases for Reversed Phase Columns	329
HPLC Column Performance	330
Inspection Reports	331
FAQ	332-335
Troubleshooting	336-339
Essential Data	340
Solvent Miscibility Table	341
Column Selection Guide	342-343
Linear Scale-Up	344
Preparative Column Selection Guide	345
Substance Index	346-351
Ordering Information Guide	352-353
Phase Overview	354-355

Introduction

Technical Information

YMC produces chromatography packing materials and HPLC columns under very strict Quality Control procedures and supplies to customers only those products which pass the strict Quality Assurance tests prior to shipment. In order to ensure the best performance and long column life, the following instructions should be followed for all packed columns.

Column Handling

- shipping solvent
- mobile phase considerations
- mobile phase replacement and column cleaning
- guard columns
- column back pressures
- temperature



1. Shipping solvent

The solvent used for shipping the column is described on the COLUMN INSPECTION REPORT or in the COLUMN CARE AND USE INSTRUCTIONS. Please determine the miscibility of this solvent with the mobile phase used in

your analysis to prevent immiscibility problems. If you intend to store the column for any length of time, you should replace the mobile phase in the column with the shipping solvent or solvent specified in the column inspection report.

2. Mobile phase considerations

Reversed phase columns can be used with both aqueous and nonaqueous solvents. However, repeated alternating between solvents with extremely different polarities can result in loss of column performance. Typical general organic solvents include acetonitrile, methanol and THF.

Cyano columns can be used in both normal and reversed phase modes. However, a column should be dedicated for use in only one separation mode and not switched between normal and reversed phase modes as this can result in loss of column performance. When using the column in a normal phase mode, replace the solvent in the column with isopropanol. (Make sure that the flow rate is set so that the pressure does not exceed 15 MPa during solvent exchange.)

Silica columns are usually used with nonaqueous solvents such as n-hexane, chloroform or other

weak solvents with the addition of isopropanol, ethyl acetate or similar as appropriate to allow elution of high polarity components.

All Amino columns (i.e. both YMC-Pack Polyamine II and YMC-Pack Amino) can be used with both aqueous and nonaqueous solvents. However, repeated alternating of solvents with extremely different polarities can result in loss of column performance

Solvent should flow in the direction of the arrow (as indicated on the column label) for normal use, although reversed flow for washing will not affect column stability.

The pH ranges for stability of every type of column varies by product. For specific information please refer to COLUMN CARE AND USE INSTRUCTIONS, downloadable from www.ymc.de, of each column.

3. Mobile phase replacement and column cleaning (general methods)

a) Reversed phase columns

When a mobile phase which contains no buffers or salts is used, wash the column with an eluent consisting of the same solvents as that of the mobile phase, but with a higher organic solvent concentration.

When a mobile phase containing buffers or salts is used, this should first be replaced with an eluent containing the same ratio of water and organic solvent as the mobile phase but which has no buffer or salt components. If the concentra-

tion of buffer or salts used is less than 100 mM, it can be replaced directly with approximately 60% acetonitrile in water.

After using a column near the usable pH limit, washing the column with water alone may cause column deterioration. Instead wash the column with a mixture of water and organic solvent containing no buffer or salt components or alternatively 60% acetonitrile in water to remove the aggressive pH eluents.

Column Handling

Should the column back pressure increase, wash the column in the reverse direction (the opposite direction of the arrow shown on the column label) making sure that the detector is not in line with the solvent stream. A solution having the same composition as that of the mobile phase, but with a higher organic solvent concentration and no added salts or buffers is usually used as the cleaning solution. However consideration should be given to the characteristics of sample so that a solvent which easily dissolves the sample is chosen.

When macromolecules, including proteins and sugars, adsorb onto the column, it is usually difficult to wash them off with organic solvents. When columns are used to analyse samples containing

such macromolecules, it is preferable to pretreat the sample and/or use a guard column

b) Normal phase columns

Wash the column with a solution having the same solvents as that of the mobile phase, but with an increased content of high polar component concentration. If polar compounds adsorb on the column, flush with isopropanol or similar solvent.

Before storing a column used with a mobile phase containing acid or alkali, replace the eluent with a simple solvent or solvent/water mixture (for example replace n-hexane/isopropanol/acetic acid (90/10/0.1) with n-hexane/isopropanol (90/10) for storage).

RECOMMENDED COLUMN CLEANING AND REGENERATING PROCEDURES

Use the cleaning routine that matches the properties of the column and what you believe is contaminating it. Flush columns with 20 column volumes (80 mL total for 4.6 x 250 mm column) of HPLC-grade solvents. Run columns in reverse flow direction, with the outlet disconnected from the detector. Cleaning efficiency is increased by increasing mobile phase temperature to 35-55°C. If the column performance is poor after regenerating and cleaning, please feel free to contact YMC directly either by phone (+49 (0) 2064 427-0), by mail (info@ymc.de) or use online chat on our homepage (www.ymc.de).

Silica-/Hybrid-/Core-Shell-based particles

Non-polar-bonded phases (Carotenoid, C18, Octyl, YMCbasic™, J'sphere™, Phenyl, PFP, Butyl, TMS):

Polar Samples	Non-polar Samples	Proteinaceous Samples
1. Water	1. Isopropanol	Option 1: Inject repeated aliquots of DMSO
2. Methanol	2. THF	Option 2: Gradient of 10 to 90% B where:
3. THF	3. Dichloromethane	A = 0.1% TFA in water
4. Methanol	4. Hexane	B = 0.1% TFA in CH ₂ CN
5. Water	5. Isopropanol	Option 3: Flush column with 7M guanidine
6. Mobile phase	6. Mobile phase	HCl, or 7M urea

Polar-bonded phases (Cyano, Diol, Amino, PVA-Sil™, Silica):

Polar Samples	Non-polar Samples
1. Water	1. Chloroform
2. Methanol	2. Methanol
3. THF	3. Dichloromethane
4. Methanol	4. Heptane or Isocyanate
5. Water	5. Isopropanol
6. Mobile phase	6. Mobile phase

Polymer-based particles: Polymer C18™

1. Flush column with mobile phase but omit buffers or salts (i.e. just organic and water, acetonitrile is preferable)
2. Run a gradient to 100% organic
3. Flush with twenty column volumes of THF
4. Flush with twenty column volumes of acetonitrile
5. Run a gradient back to starting mobile phase conditions, omitting buffers and salts
6. Re-equilibrate in mobile phase

4. Guard columns

YMC recommends that you always use a guard column with the same packing material and of the recommended inner diameter for your column (see table).

A YMC guard column is normally composed of a cartridge holder and a guard cartridge. The cartridge holder can be used repeatedly.

Where different cartridge lengths are available, only chose the longer cartridge when samples containing high levels of contaminants are present to increase the time between cartridge changes.

Guard cartridges should be changed frequently in order to maximise their protection of the main column. Cartridge holders should be connected to the main column using the shortest length of tubing possible. This tubing should be of an appropriate inner diameter for the flow rate and pressure to be used.

Samples containing particulate matter MUST always be pre-filtered (at least 0.45 µm but 0.2 µm is preferred) before being injected onto a column.

Column ID (mm)	Recommended Guard Cartridge ID (mm)
1.0	1.0
2.0 / 2.1	2.1
3.0	3.0
4.0	4.0
4.6	4.0* (4.6*)
10	10
20	20
30	30

*As a result of intense testing of the compatibility of different hardware concepts no negative influence of a 4.0 mm ID guard cartridge combined with a 4.6 mm ID main column was observed. Therefore, we recommend the use of 4.0 mm ID guards with a 4.6 mm ID analytical column.

Column Handling

5. Column Back Pressures

Column back pressure is a function of several parameters, including :-

- particle size and distribution
- packing porosity and bonded phase coating levels
- column length and inner diameter
- solvent flow rate, viscosity and temperature

Typically for a column packed with 12 nm, 5 µm ODS phase and pumped at ambient temperature with methanol:water (70:30) at 1 mL/min the back pressure should be less than 25 MPa (250 bar, 3750 psi) for 250 x 4.6 mm ID.

For wide pore (20 or 30 nm) 5 µm ODS phase and pumped at ambient temperature with methanol:water (70:30) at 1 mL/min the back pressure should be less than 17 MPa (170 bar, 2550 psi) for 250 x 4.6 mm ID.

We recommend using a column at below the maximum operating pressure to ensure maximum column life.

	Maximum Operating Pressure		
	(MPa)	(bar)	(psi)
YMC-Triart 1.9 µm	100	1000	15000
YMC-Triart 3/5 µm ¹	45	450	6525
Meteoric Core 2.7 µm	60	600	8700
YMC UltraHT 2 µm	50	500	7500

Column ID (mm)	Maximum Operating Pressure		
	(MPa)	(bar)	(psi)
0.075	55/60 ²	550/600 ²	7975/8700 ²
0.1	55/60 ²	550/600 ²	7975/8700 ²
0.3	55/60 ²	550/600 ²	7975/8700 ²
0.5	55/60 ²	550/600 ²	7975/8700 ²
1.0	20/25 ³	200/250 ³	3000/3750 ³
2.0	20/25 ³	200/250 ³	3000/3750 ³
3.0	20/25 ³	200/250 ³	3000/3750 ³
4.0	20/25 ³	200/250 ³	3000/3750 ³
4.6	20/25 ³	200/250 ³	3000/3750 ³
6.0	20/25 ³	200/250 ³	3000/3750 ³
8.0	20/25 ³	200/250 ³	3000/3750 ³
10	10	100	1500
20	10	100	1500
30	10	100	1500
YMC-Actus 20/30	30	300	4500
YMC-Actus 50	20	200	2900

¹ Novel column hardware technology with increased pressure rating (PTH type).

² The first figure is for particle sizes of 2/3/5 µm, the second figure is for particle size of 1.9 µm.

³ The first figure is for up to 150 mm column length, the second figure is for 250 mm column length.

6. Temperature

The upper temperature limit for silica and bonded phases is 50°C (70°C for YMC-Triart C18/C18 ExRS/C8, Meteoric Core C18/C18 BIO at pH=7 or lower). However YMC recommends using columns between 20 and 40°C because certain

conditions of pH or mobile phase composition may affect column lifetime. For recommended column temperatures for other column types, please refer to the instruction manual included with each column.

Mobile Phases for RP-Columns

Mobile phases for reversed phase columns

The composition of mobile phase greatly affects the separation in HPLC. To optimise a separation, it is necessary to consider the interaction between the solutes, stationary (or solid) phase, as well as the mobile phase.

For reversed phase columns, the most commonly used in HPLC, various mobile phases are available. Attention needs to be paid to a number of points when deciding on the mobile phase composition. The variables factors to be considered include:

- miscibility of solvents
- effects on detection methods (eg., UV or MS)
- effects on the column (column deterioration due to pressure or pH)
- separation reproducibility
- stability of solutes

Typical solvents for ODS columns and some helpful tips for establishing optimum separation conditions are described below.

General solvents

Water, acetonitrile, methanol and tetrahydrofuran (THF) are the important solvents for use with reversed phase columns.

It is important to use high purity water purified by ion-exchange, distillation, reverse osmosis, etc. The presence of organic substances or ionic impurities may cause problems, including ghost peaks during short wavelength UV detection or high sensitivity gradient elution systems.

Acetonitrile is frequently used as an HPLC solvent, due to its low UV absorption and low viscosity. Methanol has a higher viscosity and often shows different separation selectivity to

that obtained using acetonitrile. THF is used occasionally to influence selectivity in conjunction with acetonitrile and methanol, due to the cyclic ether structure of THF. THF has several adverse properties for a solvent for HPLC; it has:-

- significant UV absorption
- high viscosity
- a tendency to form peroxides, especially as the use of antioxidants can give rise to ghost peaks.

Appropriate separating conditions can be obtained by using these three solvents plus water individually or in combination.

Buffers and reagents

Acetic acid, formic acid, phosphoric acid and trifluoroacetic acid (TFA) are generally used as acidic modifiers. The buffers normally used include phosphate and acetate buffers (sodium, potassium, ammonium). Monobasic phosphates provide a pH of 4.6 and are used as convenient pH adjusters rather than buffers.

In order to separate ionic compounds, such as amines and carboxylic acids, with good repeatability, the pH of mobile phase must be adjusted so that it is 1 (or preferably 2) units away from the pKa of the solute. At or near the pKa, peak broadening or splitting may be observed as the free acid/base and its salt coexist.

Most buffers are used at a concentration of about 10 mM. However, depending on dissociation of solutes and interactions with the stationary phase, this can be raised to 100 mM.

When acids or alkalis which degrade reversed phases are used, caution must be taken regarding their concentrations and pH. TFA and phosphoric acid are usually used at concentrations of 0.1% or less. Acetonitrile/water (approx 60/40) solution is a convenient storage solvent after use of acids or buffers (salts).

Tetrabutylammonium salts and sodium perchlorate may be used as ion pair reagents for retention of highly polar compounds on reversed phase columns or for improvement of separation and peak shape. When these additives are used, it is necessary to use a reagent with the shortest alkyl chains available. If sodium dodecylsulfate, (SDS; which contains long alkyl chains) is used, it may be retained on the column phase and can cause problems with repeatability.

Other solvents for HPLC

Ethanol, 2-propanol, ethyl acetate, or chloroform may be used in the mobile phase (particularly in normal phase separations) in order to improve retention or separation of solutes. In some cases, hexane is used as a mobile phase. When a hydro-

phobic solvent is added to a mobile phase, care must be taken with regards to the miscibility with the mobile phase existing in the column and a separate wash stage should be included before changing the eluent.

HPLC Column Performance

HPLC Column Performance

Important factors used to evaluate column performance include column efficiency, capacity, separation characteristics of solutes, peak shape and column pressure. The parameters used to assess column performance by YMC are defined below.

Column efficiency, an important characteristic for evaluation of column performance, is generally measured in terms of theoretical plate number. This is calculated using peak width at half-height. Narrower peak widths result in higher theoretical plate numbers. Longer columns and smaller packing material particle size also result in higher theoretical plate numbers. Due to a variety of factors, one column does not always show the same theoretical plate number. This may be caused by differences between linear velocity and solute diffusion in the column or because of

interaction between solutes and the mobile phase or the stationary phase.

For these reasons, column efficiency is solute specific and the measurement of efficiency must be conducted under nearly identical HPLC conditions for results to be directly comparable.

Retention and separation characteristics for solutes on the column are evaluated by the capacity factor and separation factor values.

These values are indices of the packing material characteristics and, in contrast to the retention time, are independent of column inner diameter and length.

Elution peak shape is also an important factor for evaluation of column performance. The asymmetry factor is a relatively simple measurement, usually calculated at 10% of peak height.

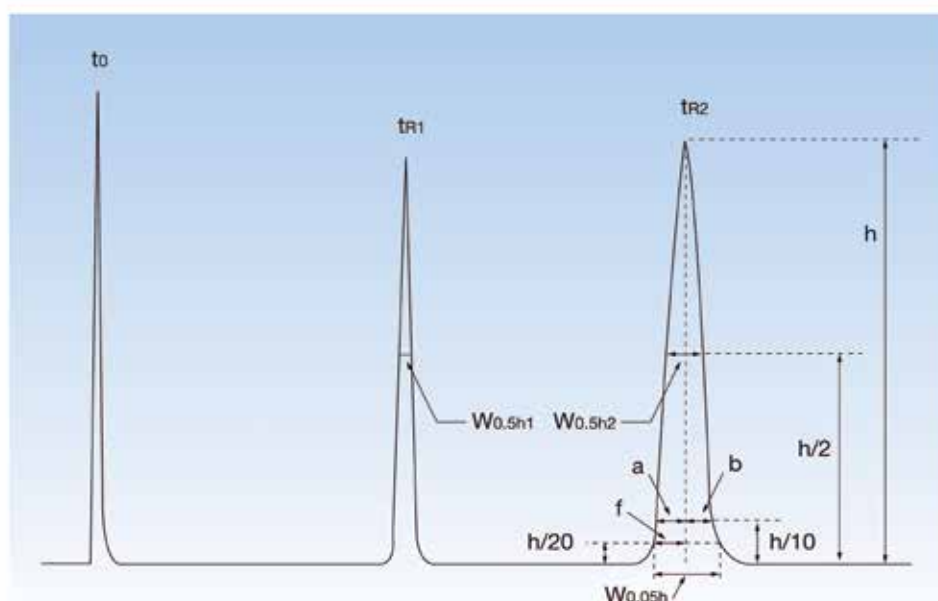

t_0 Void volume. Column dead-time

t_R Retention time

h Peak height

$W_{0.5h}$ Peak width at half-height

N Theoretical plate number

k' Capacity factor

α Separation factor

R_s Resolution

A_s Asymmetry factor

T_f Tailing factor

$$N = 5.54 \times (t_R / W_{0.5h})^2$$

$$k' = (t_R - t_0) / t_0$$

$$\alpha = k'_2 / k'_1$$

$$R_s = 1.18 \times (t_{R2} - t_{R1}) / (W_{0.5h1} + W_{0.5h2})$$

$$A_s = b/a$$

$$T_f = W_{0.05h} / 2f$$

Inspection Reports

Formation

YMC employs strict quality control of packing materials to ensure lot-to-lot and column-to-column reproducibility. All packed columns are subject to performance tests and only those columns which meet strict specifications are shipped to customers.

A test report (see below) is shipped with each column. The test method shown on this inspec-

tion report is not only a method used for column performance evaluation but can also be used as a test method for determination of column life. We provide full details of all the analytical conditions, used test method, including compounds analysed, sample concentration, eluent composition, etc. to allow the end user to reproduce these tests.

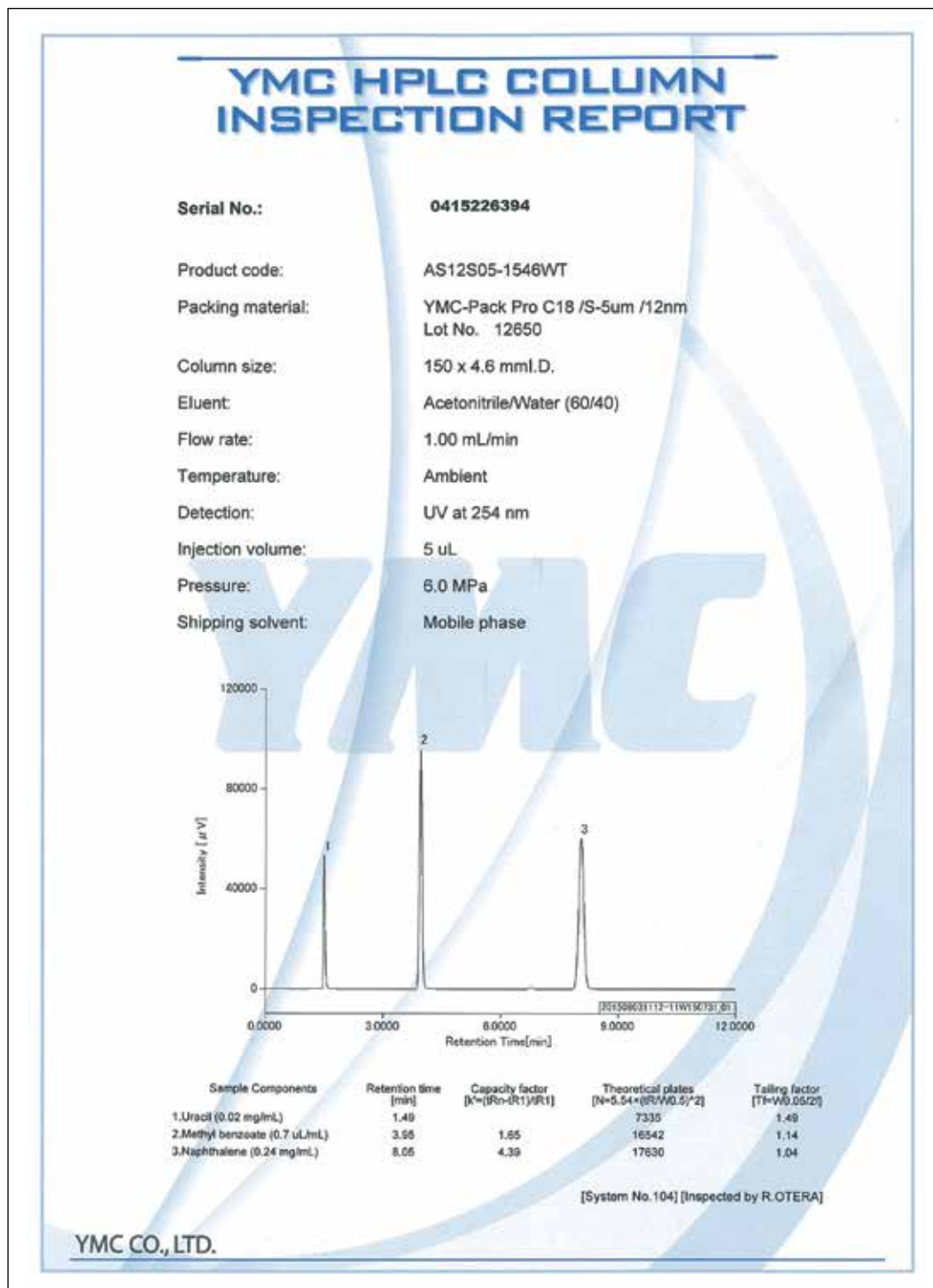

Frequently Asked Questions



What is “Endcapping”?

Conventional ODS (C18) packing materials are silica gel bonded with octadecyl groups. This is the result of reaction between silanol groups on the silica surface and octadecyl groups. However some active silanol groups remain after the reaction. It is impossible for all the silanol groups to react because of steric hindrance of octadecyl groups. Such residual silanol groups create a secondary interaction in chromatography, which, in many cases, affects on chromatograms by causing peak tailing of basic compounds or irreversible absorption to the column. Therefore, a secondary silanisation reaction with residual silanol groups using a small reagent (typically trimethylsilane) should be performed. This process is called “endcapping”.



Are there ODS columns used with 100% aqueous mobile phase?

YMC-Triart C18, Hydrosphere C18 and YMC-Pack ODS-AQ columns can be used with 100% aqueous mobile phase. With conventional ODS columns, retention time becomes shortened due to the incompatibility between water molecules and the silica bonded surface with high hydrophobicity. Water tends to be expelled from the pores on material and the C18 chains “collapse” onto themselves. The retention time is hardly affected for YMC-Triart C18, Hydrosphere C18 and YMC-Pack ODS-AQ columns because the silica surface is capable of solvation between mobile phase and hydrophilic silica surface as a result of the reduced C18 functional group density and the proprietary modification process.



What is the upper limit of column pressure?

Column length of 150 mm or less and diameters less than 10 mm:
20 MPa (200 bar, 3,000 psi)

Column length of 250 mm or greater and diameters less than 10 mm:
25 MPa (250 bar, 3,750 psi)

UHPLC columns (1.9 μ m): 100 MPa (1,000 bar, 15,000 psi)

Triart columns (3/5 μ m; novel column hardware): 45 MPa (450 bar, 6525 psi)



How should we store the columns?

When columns are not used for a long time, they should be stored in a cool place after replacing the eluent with the shipping solvent as described in the Inspection Report. Do not store the column in the mobile phase with salt or acid, even for very short times. Close the airtight stopper tightly to prevent the solvent from evaporating.



How can we evaluate the performance of columns?

Repeat the performance test using exactly the same conditions as the Inspection Report which accompanies the column at the time of purchase. Columns which show no change in retention time, theoretical plate number, peak asymmetry, etc are acceptable for further use.

Columns which show no change in these parameters after several years of use may, however, have changes in separation characteristics for certain types of compounds such as ionic species. It is advisable to avoid using such columns for method development as reproducibility compared to new columns may not be possible.

Frequently Asked Questions

1. To remove strongly adsorbed hydrophobic material; pump the column in the reverse direction with eluent with a greater elution ability than mobile phase. For example, for cleaning reversed phase columns, use an eluent with increased ratio of organic modifier and flush the column with at least 10 column volumes.

2. To recondition the gel surface condition caused by damage resulting in generation of active silanol groups, and observed as irregularities in peak asymmetry and retention time. Washing with acidic solvents can be effective in such cases. Typically a mixed solvent of 0.1% aqueous phosphoric acid solution and organic solvent (between 10 and 60% organic content) can return the silanol groups to the dissociation state.

How do I clean the columns?



YMC recommend the use of guard columns, particularly if the samples being analysed contain a high level of contaminants. This will extend the useful lifetime of a column, particularly if replaced at frequent intervals. We recommend that guard columns are packed with the same packing material as the analytical column. Guard columns with different material may cause abnormalities in peak asymmetries and reproducibility. YMC guard cartridges are particularly economic when frequent replacement is required.

Do we need guard columns?



Recommended flow rates for semi-micro column (1.0 to 3.0 mm inner diameters) are:-

1.0 mm ID	0.05 mL/min
2.1 mm ID	0.2 mL/min
3.0 mm ID	0.4 mL/min

This can be increased if the column length is short and the system back pressure is low.

Such columns can be used in conventional HPLC systems but it is advisable to use short lengths of smaller diameter connection tubing and detector flow cells which are optimised for low flow rates.

What is required in system and flow rate for using semi-micro columns?



Step 1: Determine separation conditions by using analytical columns.

Step 2: Study the preparative scale. Select the particle size of the packing material and the inner diameter of column appropriate for the sample volume.

Step 3: Optimise the separation conditions using analytical columns with inner diameter of 4.6 mm or 6.0 mm packed with the packing material selected for the preparative separation (scout column). If the particle size of the packing material is the same as in the Step 1, this process can be omitted. If the preparative column is more than 100 mm ID, it is advisable to insert another step with a scout column of 20 mm ID in order to accurately predict loadability and calculate the running costs.

Step 4: Proceed with the preparative separation.

How do I carry out a scale-up of a method?



Frequently Asked Questions



What should I do when the column pressure increases?

Depending on the reasons for increased pressure, the following procedures are recommended:-

Blocked frits: Flush the column in reverse flow as described on page 326-327. Reduce the flow rate in order to keep the column pressure within recommended limits whilst flushing the column.

Contamination of the packing material: Wash the column in reverse flow as described on page 326-327.

If pressure increases occur frequently despite treatment as above, it is recommended that sample pretreatment or the use of guard columns is employed to prevent the problem occurring in the first place.



What are the solutions for poor peak shapes?

The following solutions are recommended, depending on the cause.

Inappropriate Mobile phase: If pKa of the analyte and pH of mobile phase are close for ionic analytes, it will result in poor peak shape. Set the pH of mobile phase at least 1 (or better 2) units from pKa.

Effect of solvent used to dissolve sample: If the dissolving solvent of sample and mobile phase are not the same, it causes defects in the peak shape. Dilute the sample solution with mobile phase or reduce the injection volume.

Overloading sample injection: Overloading the column will cause defects in the peak shape. Reduce injection volume and/or the sample concentration.

Insufficient equilibration time: When the difference in pH between the current and a previous mobile phase is wide or the buffer concentration of mobile phase is low, column equilibration may take some time

Column contamination and degradation: If the column is contaminated, wash the column as described on page 326-327. If the column is degraded, it is not possible to regenerate it and it should be replaced.

System problems: Dispersion of the sample may occur within the tubing between the injector and the column or within the flow cell of detector which can result in peak tailing and/or broadening. Optimisation of the system for use with semi-micro use should be performed.



What are the solutions for ghost peaks?

The following solutions are recommended, depending on the cause.

Injector fouling: If the ghost peak(s) appears when injecting only mobile phase (no sample), wash the injector.

Gradient Analysis: When hydrophobic impurities are eluted by a stronger solvent, they appear as ghost peaks. Clean the column as described in the Instruction Manual. If this does not eliminate them, they are probably due impurities of solvent. Use a higher grade solvent, purified specifically for HPLC or alternatively install a guard column between the solvent delivery pump and the mixing chamber or injector.



What should I do if columns dry out?

Flush the column with a solvent such as methanol for all bonded phase silica or hexane for non bonded silica and remove trapped air using a flow rate such that the column pressure is about half that normally used for analysis. When all the air has been removed, check the column performance by running a test chromatogram under the conditions stated on the original Column Inspection Report.

Frequently Asked Questions

This can arise for a number of reasons:-

Inappropriate mobile phase conditions:

It may become difficult to obtain reproducibility when analysing ionic compounds, if the pH of mobile phase is not controlled or the buffer concentration is low. Increase the buffer concentration.

Retention time can fluctuate widely due to a slight variance of pH when the pH of a mobile phase is set too close to the pKa of analyte. Set the pH of the mobile phase to be at least 1 (or preferably 2) units away from the pKa.

System variance: It may be difficult to obtain reproducibility in chromatograms when using different HPLC systems. Where possible the manufacture of pumps, detectors and injectors should be the same, otherwise differences in extra column volume from mixing chamber, detector cell and plumbing will result in poor reproducibility between systems. Also, with column heaters from different manufacturers, there may be an effect on the retention time due to the set temperature being different between the 2 systems. Use of the same system throughout a sequence of analysis is recommendable.

Column histories: Reproducibility between chromatograms may not be obtained when using different columns of the same type. This is due to differences in the columns' prior histories. For example, changes in the chemistry of the surface of the packing material can arise by use of mobile phases containing ion pair reagents or when strongly hydrophobic material (especially proteins) becomes adsorbed on the column. Dedicating a column to a specific application is recommended.

Using 100% aqueous mobile phase: Reproducibility of chromatograms obtained on conventional ODS columns will not be obtained when using 100% aqueous mobile phase due to the short retention times obtained. Columns which can be used in 100% aqueous mobile phase are recommended. YMC recommends the use of either YMC-Triart C18, Hydrosphere C18 or YMC-Pack ODS-AQ which are designed to be used in 100% aqueous mobile phase.

Grade difference in mobile phase: Reproducibility between chromatograms may not be obtained when using different grade of solvent in a mobile phase. Impurities contained in a solvent can act like salts in mobile phase and affect the separation. Solvent in HPLC grade is recommendable.

What should I do if the column fails to provide reproducibility?



This is caused by excess of ion pair reagent. In general, the higher the concentration of ion pair reagent, the greater the retention. However, if the concentration of ion pair reagent is above a certain level, the retention may become poor because of micelle formation. Good separations are achieved when the concentration of ion pair reagent is between 5 mM to 20 mM. YMC recommend that the lowest possible concentration is used to avoid short column life.

I still have poor retention after adding ion pair reagent to mobile phase. Why?



Please feel free to contact YMC with any issue either by phone (+49 (0) 2064 427-0), by mail (info@ymc.de) or use our online chat on our homepage (www.ymc.de).

Troubleshooting

1. Consideration of solvent grade for reversed phase LC

Reversed phase liquid chromatography frequently employs organic solvents such as methanol, acetonitrile or tetrahydrofuran. Although HPLC grade products of these types of solvents are available, it seems some users have trouble when using a reagent grade solvent instead of HPLC grade. This results in them wasting considerable amounts of time. How do the two solvent grades differ?

Methanol and acetonitrile

Reagent grade solvents contain larger amounts of UV absorbing impurities than HPLC grade solvents do, which makes it difficult to use them for gradient elution or trace analysis, especially when the detection requires short wavelength. This gives rise to significant increases in baseline

noise or detection sensitivity. In some cases (or at some wavelengths) it might be possible to use a reagent grade solvent, but we recommend the use of HPLC grade solvents whenever possible.

Tetrahydrofuran

Tetrahydrofuran easily generates peroxides. To prevent this, the solvent generally contains antioxidants which can cause ghost peaks. As a result, solvent containing no antioxidants should be used in HPLC. The peroxides in tetrahydrofuran also have a marked effect on the baseline stability (with differences between grades and between different suppliers being greater than for other organic solvents), which leads to the recommendation that HPLC grade solvent with little or no impurities should be used.

2. Eluent conditions

Although a column is frequently thought to be the cause of HPLC analysis not providing the correct trace, many failures are attributed to causes other than the column, including improper maintenance operations. This discussion illustrates the case in which the grade of a solvent affects the peak shapes. In the chromatogram for basic compound analysis, using an eluent of acetonitrile/water, Peak 2 represents the basic compound.

Figures right show chromatograms from two identical operations except that the acetonitrile used was of different grades. One was HPLC grade (Figure 1); the other was reagent grade (Figure 2). While the peak shape was broadened with HPLC grade acetonitrile, it was much improved when using reagent grade. The differences in peak shapes which were observed were also found to be dependant on the different makers even though they were of the same specific grade. This may be the effect of traces of impurities contained in acetonitrile behaving in the same way as modifiers added to an eluent. Replacing eluent with acetonitrile / 5 mM ammonium acetate produced

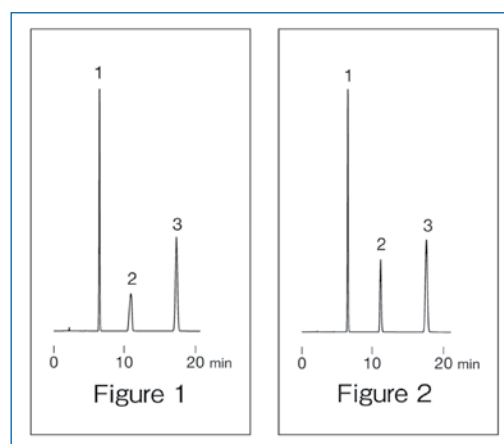

the chromatogram shown in Figure 2 irrespective of the grade of solvent. To avoid the influence of different grades, solvents specifically made for HPLC must be used. Even compounds which have groups which can dissociate can be analysed with eluent containing no acid or salt, although eluents with additives such as salt must be used when reproducibility is important.

Troubleshooting

3. Peak shape anomaly

A common problem encountered during HPLC operations is peak shape anomalies such as peak tailing and double peaks. In order to remove these problems, the cause must be precisely determined. The majority of cases are the result of inappropriate conditions for the separation; including inappropriate selection of column or solvent, or use of an old column which has a void to the packing at the top of the packing. Here we discuss the method of determining the cause of the problem with peak shapes.

The simplest way is to test the column performance using the "shipping inspection criteria" as

described in the Column Inspection Report which is included with every column. If the examination reveals no peak shape anomaly, then the cause will be the result of inappropriate selection of separation condition. The separation condition such as eluent selection must be reconsidered. If, on the contrary, the same examination reveals any anomaly, the column may be the problem. Flushing (to remove the impurity could have accumulated on the column) or replacement of the column is necessary. We recommend examining column performances on a regular basis and always under the identical conditions.

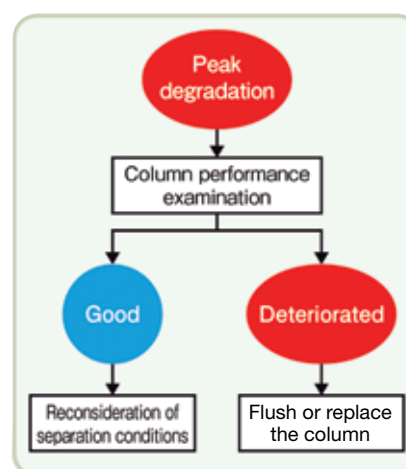
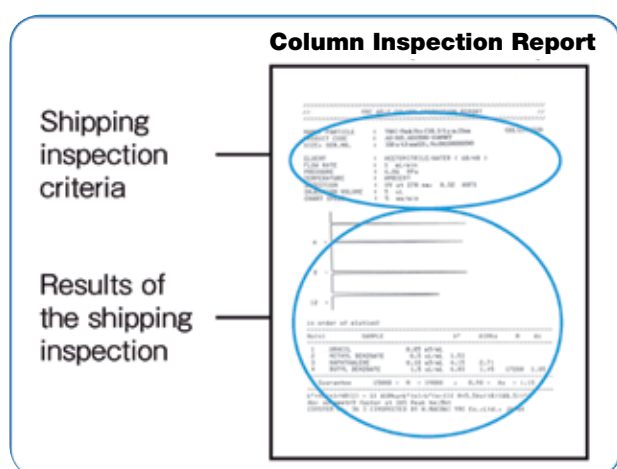

YMC provide sufficient analytical information, including sample concentration, in the Column Inspection Reports to allow customers to evaluate the performance of the column using standard compounds.

4. Column Pressure Increases

Pressure increase is a common problem in HPLC. Some of the reasons for pressure increases in reversed phase chromatography are discussed below.

If the system pressure increases, you should first disconnect the column and run the system to determine the line pressure. If the line pressure is high, the tubing may be clogged or damaged. If there is no excessive line pressure, then the column pressure may be high and the column needs cleaning. Cleaning by pumping in the reversed direction can be very effective. Generally, the relative proportion of the organic solvent in a mobile phase should be increased when washing, to speed up removal of bound material. However, the key consideration is to choose, in accordance with the characteristics of the sample, an appropriate solvent that will easily dissolve the adsorbed

material and not cause precipitation. Reversed phase separations often cause protein to be adsorbed by the packing material which results in high pressure. This problem can be overcome effectively by gradient washing with acetonitrile/water containing 0.1% TFA, rather than washing with an organic solvent. If the cause of high back pressure is believed to be the result of insoluble material in samples or precipitation of a sample during separation, washing or replacing the inlet frit may be successful.

However, once high back pressures occur, it frequently becomes difficult to restore performance despite washing, etc. It is far better to prevent increased column pressure from occurring by simple sample preparation such as protein removal or filtration and using a guard column to protect the analytical column.

Troubleshooting

5. The Cause of the Ghost Peaks

As part of a test of a gradient method a chromatogram was run without a sample being injected. A number of peaks were obtained, as in trace (A). When a similar test was performed, but with the column disconnected, the ghost peaks disappeared, as in trace (B). This led to the idea that the column was at fault.

However, despite flushing and replacing the column, the baseline could not be improved. Several other factors were then examined; the cause was found to be water used to prepare the mobile phase. Standard distilled water (which is inadequate for HPLC) had been mistakenly used. When HPLC grade distilled water was used, an excellent baseline as in trace (B) was obtained.

Water purity can have a great impact on gradient elution. Even HPLC grade distilled water will become contaminated with time, causing ghost peaks. This will have no significant influence on isocratic elution methods, but it will cause problems in gradient elution methods.

In gradient elution methods, a column is equilibrated with an eluent with low organic content. This allows impurities in the eluent to be adsorbed and concentrated in the column. After starting the analysis, the amount of organic solvent increases and impurities begin to elute from the column,

resulting in ghost peaks. The heights of the ghost peaks are dependent on the duration of equilibration (the amount of contaminant adsorbed during equilibration).

Such ghost peaks do not appear when the column is disconnected because there is nothing to adsorb and concentrate the impurities during the equilibration stage. Therefore, in gradient analysis, the grade and storage conditions of all solvents requires great care.

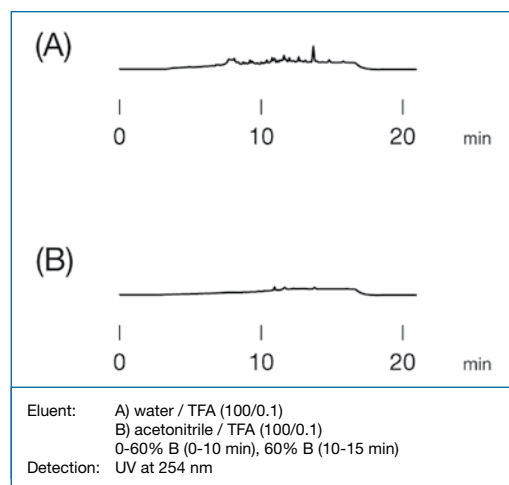

6. pH Adjustment of Eluents

Analysis of ionic compounds by reversed phase HPLC has to be performed with the pH of eluent controlled using acid or buffering agent. However, separation at a pH which is not the optimum for the compound of interest can cause problems such as double peak or peak broadening. Even if the peak shape is satisfactory, retention time reproducibility may not be obtained in some cases. The relation between retention of benzoic acid and pH value is shown in the figure below. Although the retention time (measured as k') varies little when the pH is in the range 2 - 3.5, it varies widely when the pH ranges is in the range 3.5 - 4.5. The pK_a of benzoic acid is 4.2 and it is noticeable that the region where the retention time varies most widely is near the

pK_a . If the eluent pH is adjusted to a value near the pK_a , the results may not be reproducible due to very small variations of the pH adjustment having a large impact on the retention time. In fact, the eluent pH variation of just 0.1 will affect the separation significantly. Therefore, it is recommended that the eluent pH should be more than 1 unit away from the pK_a .

If the pK_a of the analyte is unknown, the eluent pH should be adjusted to within the value where the impact on the separation seems minimal, after having evaluated the relation between the eluent pH and the retention time by using several eluents with their pH values adjusted to be slightly different from each other.

Troubleshooting

7. Regenerating Columns

In reversed phase HPLC, column deterioration can cause poor peak shapes and/or reduced retention times. The column deterioration is the result of changes in the packing material's structure, such as the loss of bonded phase (eg C18 chains) or dissolution of the silica gel base material. Should this occur, columns are difficult to restore and reuse.

If 100% aqueous mobile phase is used in an ODS column, a sharp reduction in retention times of compounds can arise (as in the figure below). Whilst some may think this reduction in retention time is due to column deterioration, this is not the case. In this case, the cause is due to the

decrease of apparent hydrophobicity of the packing material due to polarity difference between the water and the C18 functional groups, leading the C18 chains to collapsing onto themselves. In some cases where this occurs, the initial retention times can be restored by flushing the column with 10 times its volume of mobile phase containing 50% organic solvent.

This decreases the repulsion between the eluent and the C18 chains and allows them to return to their normal pendant state. However, YMC recommend that columns specifically intended for 100% aqueous eluents should be used to prevent this problem arising.

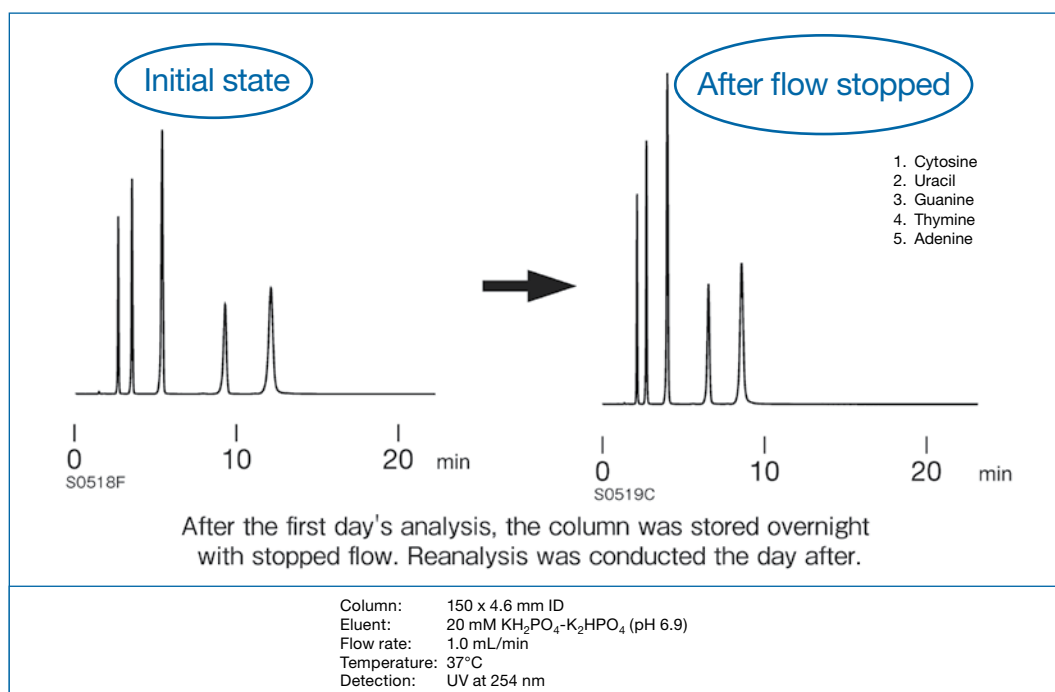

Essential Data

Conversion factors

Pressure

MPa	bar	psi	kgf/cm ²	atm
1	10	145.04	10.20	9.87
0.1	1	14.504	1.020	0.987
6.90x10 ⁻³	0.069	1	0.070	0.068
0.0981	0.981	14.223	1	0.968
0.101	1.013	14.696	1.033	1

Length

m	in	ft	yd	mile
1	39.37	3.28	1.094	6.21x10 ⁻⁴
0.025	1	0.083	0.028	0.15x10 ⁻⁴
0.305	12	1	0.33	1.89x10 ⁻⁴
0.91	36	3	1	5.68x10 ⁻⁴
1609.3	63360	5280	1760	1

Weight

kg	oz	lb
1	35.274	2.204
0.0283	1	0.0625
0.454	16	1

Volume

l	gal(UK)	gal(US)
1	0.22	0.26
4.55	1	1.201
3.79	0.83	1

Temperature

K	°F	°C
0	-459.67	-273.15
255.37	0	-17.8
273.15	32	0
298.15	77	25
310.93	100	37.8
373.15	212	100

Ratio Scale

ppb	ppm	%
1	10 ⁻³	10 ⁻⁷
10 ³	1	10 ⁻⁴
10 ⁷	10 ⁴	1

formula: °C=(°F-32)x5/9 °F=°Cx9/5+32

SI Prefixes

da (deca)	h (hecto)	k (kilo)	M (mega)	G (giga)	T (tera)	P (peta)	E (exa)	Z (zetta)	Y (yotta)
10 ¹	10 ²	10 ³	10 ⁶	10 ⁹	10 ¹²	10 ¹⁵	10 ¹⁸	10 ²¹	10 ²⁴

d (deci)	c (centi)	m (milli)	μ (micro)	n (nano)	p (pico)	f (femto)	a (atto)	z (zepto)	y (yocto)
10 ⁻¹	10 ⁻²	10 ⁻³	10 ⁻⁶	10 ⁻⁹	10 ⁻¹²	10 ⁻¹⁵	10 ⁻¹⁸	10 ⁻²¹	10 ⁻²⁴

1 Å (ångström) = 0.1 nm = 10⁻¹⁰ m

Linear scale-up

Inner Diameter	1.0	2.0	3.0	4.6	10.0	20.0	30.0	50.0
Scale-Up factor	0.0473	0.189	0.425	1	4.73	18.90	42.53	118.15

Column Selection Guide

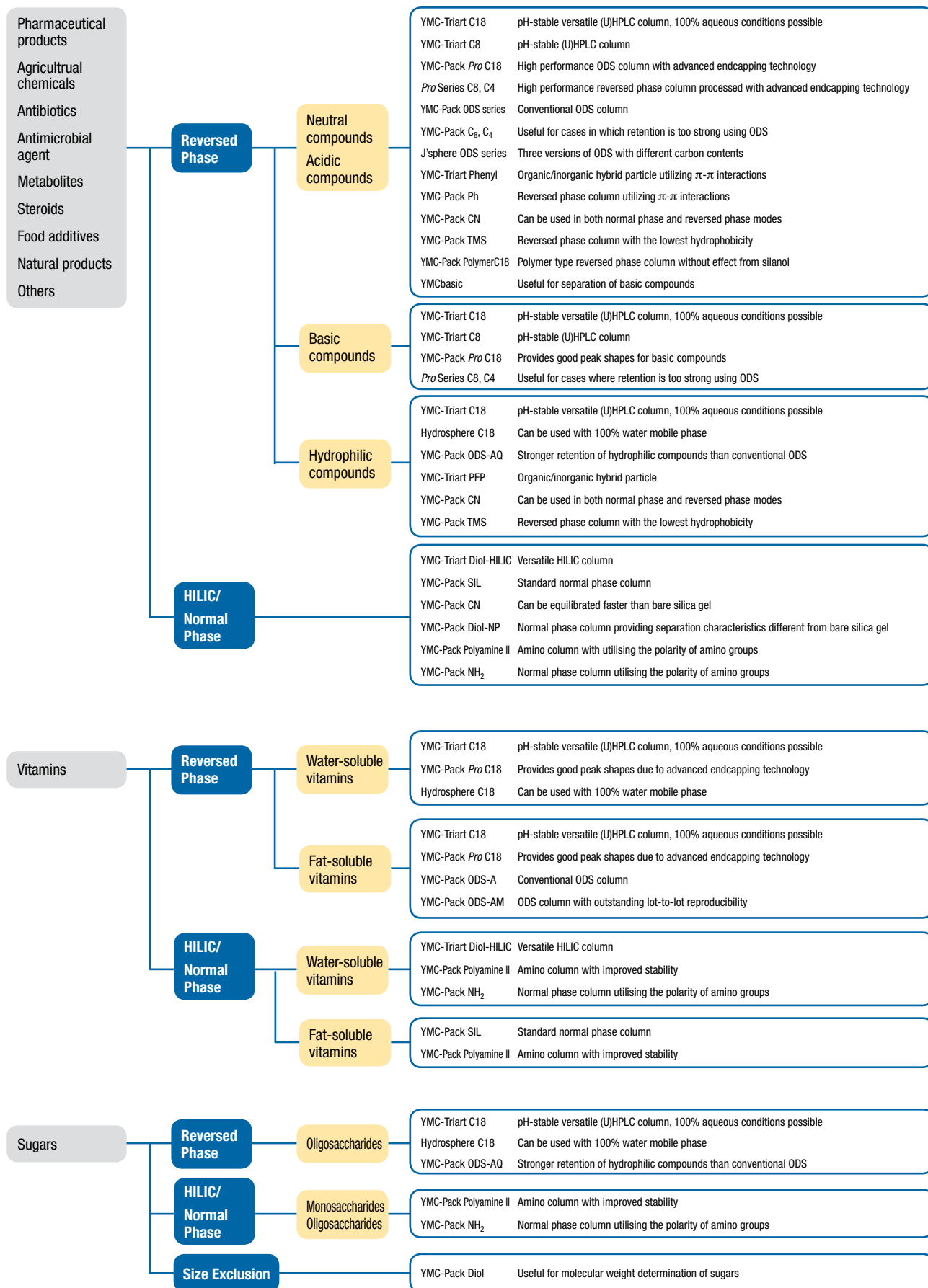

Column Selection Guide

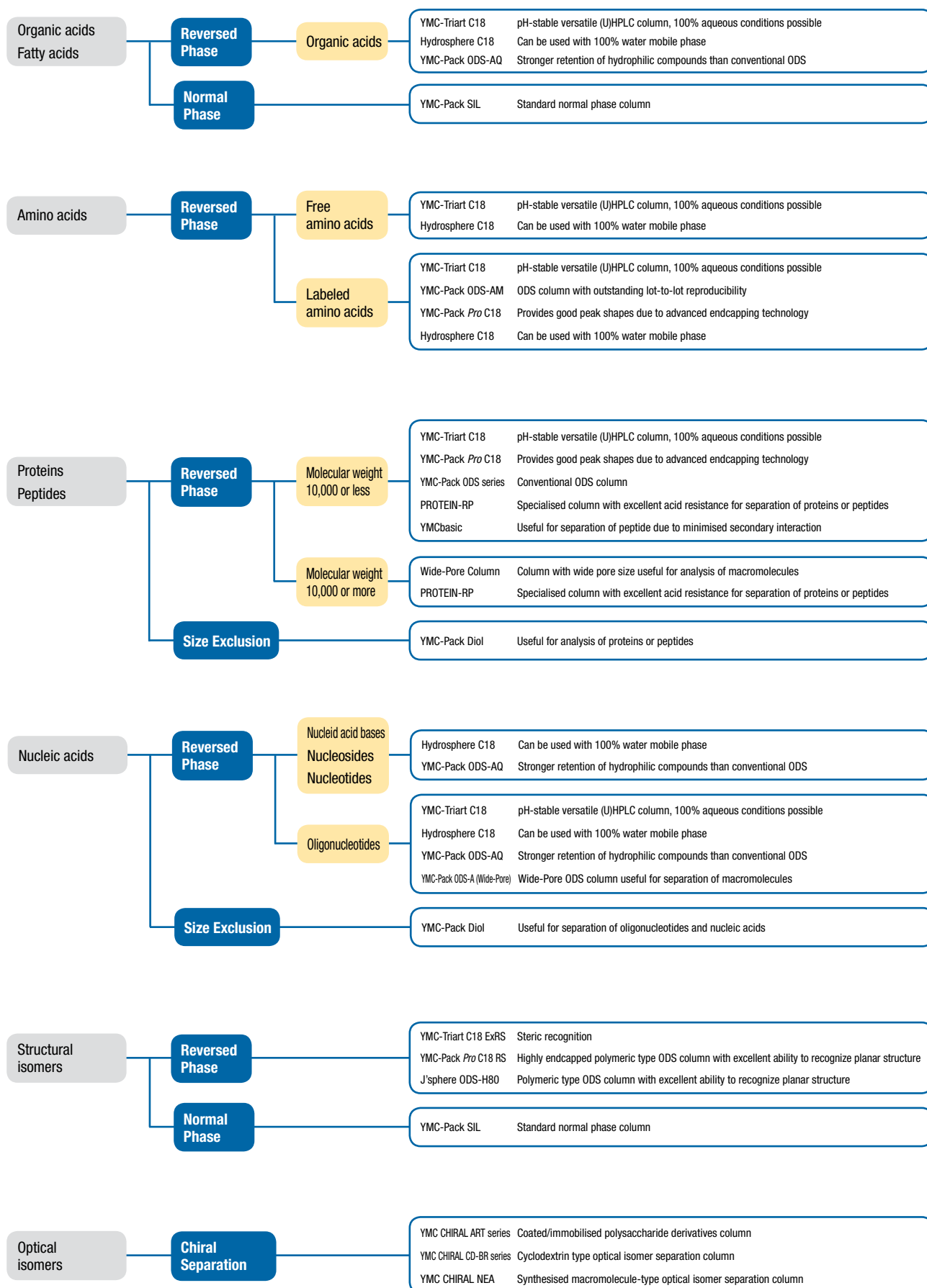

Linear Scale-Up

In order to simplify your scale-up the three most important scale-up factors are summarised.

Scalable factor SF	ID "Linear Scale-Up"	Column length	Column length and ID "Volume"
	$SF = r_{ID, prep}^2 / r_{ID, anal.}^2$	$SF = l_{ID, prep} / l_{ID, anal.}$	$SF = (r_{ID, prep}^2 / r_{ID, anal.}^2) / (l_{ID, prep} / l_{ID, anal.})$
Impact	Flow rate Eluent composition	Retention time Cycle time Plate number	Amount of adsorbent

Linear Scale-Up

In most cases it is beneficial to develop a semi-preparative method on an analytical scale column.

The analytical separation carried out on a 150 x 4.6 mm ID column has to be scaled up to 150 x 20 mm ID. Therefore the chromatographic parameters such as flow rate and column load have to be adjusted according to the following equation:

Linear Scale-Up

$$SF = \frac{\Pi_{ID, prep}^2}{\Pi_{ID, anal.}^2} = \frac{m_{prep}}{m_{anal.}}$$

$$SF = r_{ID, prep}^2 / r_{ID, analytical}^2$$

$$SF = 20^2_{ID, prep} / 4.6^2_{ID, analytical}$$

$$SF = 18.9$$

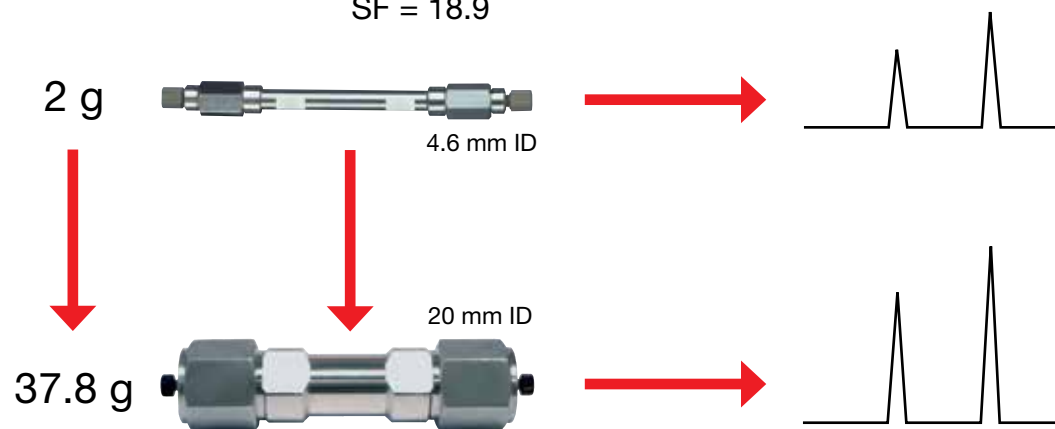

Inner diameter \longrightarrow loadability / compound

Guideline for Sample Load according to column ID

Column ID (mm)	Scale-Up factor	Loadability (mg)
4.6	1	1-4
10	4.7	5-20
20	18.9	20-80
50	118	80-350
75	266	270-980
100	472	470-1900
150	1060	1000-4200

Preparative Column Selection Guide

Optimisation of preparative chromatography

The main task for a preparative chromatographer is to find the suitable system. In order to simplify the considerations YMC developed a "Preparative Column Selection Guide".

		Column efficiency ^{※1} Pressure ^{※1} Cost ^{※1}					
		High ←					→ Low
Standard sample load	Particle size (µm) Inner diameter (mm ID)	spherical					Irregular
		5 N = 90000 ^{※2}	10 N = 40000 ^{※2}	15 N = 20000 ^{※2}	20 N = 10000 ^{※2}	50 N = 5000 ^{※2}	230/70 mesh N = 2500 ^{※2}
For investigation -tens-of-mg	4.6, 6.0	○	○	○	○	○	○
	10, 20	⊙	⊙	○	○	○	○
-hundreds-of-mg	50	○	⊙	⊙	○	○	○
	100, 150		○	⊙	⊙	○	○
g	200			○	⊙	⊙	○
	300 or more				○	⊙	○

⊙ Most appropriate ⊖ Appropriate ○ According to the purpose

※1 Value per unit length
 ※2 Standard theoretical plate number per m

The "Preparative Column Selection Guide" will help to select:-

1. the column ID for the required sample loading
2. the particle size for optimum efficiency
3. the column length for the necessary resolution

Scale-Up

The YMC Scale-Up is defined by 4 steps:

1. Analytical Scale: Method Development

Determine separation conditions by using analytical columns packed with different stationary phases and various conditions.

2. Study the preparative scale. Select the particle size of the packing material and the inner diameter of column appropriate for the sample volume.

3. Optimise the separation conditions and perform loadability studies using analytical columns with inner diameter of 4.6 mm or 6.0 mm packed with the packing material selected for the preparative separation (scout column). If the particle size of the packing material is the same as in the Step 1, this process can be omitted. If the preparative column is more than 100 mm ID, it is advisable to insert another step with a scout column of 20 mm ID in order to accurately predict loadability and calculate the running costs.

4. Proceed with the preparative separation with scale-up of chromatographic parameters such as flow rate/ column ID/ sample load as necessary.

From all the given steps above the most demanding step will be the scale-up of the chromatographic parameters in order to meet the preparative demands.

There are a number of scalable parameters: flow rate, column ID, sample load, tubing ID, sample injection concentration, volume of sample loop, consumption of solvent, dead volume, fraction mass, size of the detector cell.

Substance Index

To get full access to more than 750 YMC applications please visit our homepage www.ymc.de, where you can easily search for substances, phases etc.

	Refer to this catalogue on page	Refer to brochure YMC-Triart	Refer to brochure Chiral columns		Refer to this catalogue on page	Refer to brochure YMC-Triart	Refer to brochure Chiral columns
A							
Acacetin	110			Asulam	19	●	
Acenaphthene.....	123,132,286,287			Atenolol.....	23	●	
Acenaphthylene.....	286,287			Atorvastatin calcium hydrate.....	43	●	
Acesulfam-K.....	21	●		5'-ATP.....	145		
Acetaldehyde 2,4-DNPH.....	157			Atraton.....	291		
4-Acetamidoacetophenone.....	26	●		Atrazine.....	291		
2-Acetaminophenol.....	27	●		Atropine sulfate.....	37,112,251		●
2-Acetamidophenone.....	26,27	●		Azoxystrobin.....	19	●	
Acetaminophenone.....	26	●		AZT.....	157		
Acetanilid.....	26,27	●		B			
Acetic acid.....	50,58,140,149	●		Baicalein.....	41,110,140	●	
Acetone 2,4-DNPH.....	157			BAM-12P.....	98,217		
Acetylacetone.....	291			Barbaloin.....	140		
6''-o-Acetylaidzin.....	44,111-113	●		Barbital.....	39	●	
6''-o-Acetylgenistin.....	44,111-113	●		Beclomethasone.....	143		
6''-o-Acetylglucitin.....	44,111-113	●		Benfotiamine.....	291		
N-Acetylglucosamine.....	228			Benzaldehyde 2,4-DNPH.....	157		
N-Acetylprocainamide.....	125,151			Benzene.....	120,218		
Acetylsalicylic acid.....	27	●		Benzethonium chloride.....	25	●	
Aciclovir.....	42	●		Benzo [a] anthracene.....	286,287		
Acrolein 2,4-DNPH.....	157			Benzo [a] pyrene.....	286,287		
Acrylic acid.....	50	●		Benzo [b] fluoranthene.....	286,287		
Acylysterglycosides.....	171			Benzo [g,h,i] perylene.....	286,287		
Adenine.....	48,49,51,126,133,140	●		Benzo [k] fluoranthene.....	286,287		
Adenosine.....	141,226			Benzoic acid.....	125,131,147,161		
Adenylate kinase.....	203,209,211			Benzoin.....	248,257		●
5'-ADP.....	145			Betamethasone.....	143,293		
ADP-D-glucose.....	143,153			1,1-Bi-2-naphthol.....	263,264		●
Adrenaline.....	35,140	●		Biotin.....	51,155,157,159	●	
Aflatoxin B1.....	292			Bisbentiamine.....	291		
Aflatoxin B2.....	292			Bradykinin.....	131,201,220		
Aflatoxin G1.....	292			Brassicasterol.....	147		
Aflatoxin G2.....	292			Brilliant blue FCF.....	34	●	
L-Alanine.....	145			BSA.....	149,156,189,190,206,215,216,218,220,320		
Albumin.....	207			Buckminsterfullerene (C60).....	155		
Allergens.....	88,89			Bufalin.....	147		
p-Aminobenzoic acid (PABA).....	155,157,159			n-Butylbenzene.....	31,119,132,307	●	
4-n-Butoxybenzoic acid.....	101,114,116			Butyl benzoate.....	108,109,121,236		
4-Aminophenol.....	26	●		C			
Amitriptyline HCl.....	24,31,123,132	●		Caffeine.....	27,116, 118,120,161,307		
Amlodipine besilate.....	42,43	●		Campesterol.....	147		
5'-AMP.....	145			Candesartan ciclexetil.....	43	●	
Ampicillin.....	90			Canthaxanthin.....	285		
n-Amylbenzene.....	119			Capronaldehyde 2,4-DNPH.....	157		
Amyloid β-protein.....	98,216,217			Capsaicin.....	74		
Androsterone.....	293			Capsanthin.....	285		
trans-Androsterone.....	293			Carbadox.....	143,293		
Angiotensin I.....	22,131,201,220,311	●		Carbamazepine.....	123		
Angiotensin II.....	22,131,201,210,215,311	●		Carbonic anhydrase.....	201,207		
Angiotensin III.....	22,201,311	●		trans-α-Carotene.....	285		
Anthracene.....	286,287			trans-β-Carotene.....	285		
α1-Antitrypsin.....	201,207			δ-Carotene.....	285		
Apigenin.....	110			9-cis β-carotene.....	285		
Arbutin.....	122,140			13-cis β-carotene.....	285		
L-Arginine.....	145			15-cis β-carotene.....	285		
L-Ascorbic acid.....	44,51,53,159	●		Carvedilol.....	43	●	
L-ascorbic acid 2-glycoside.....	44,51	●		(+)-Catechin.....	292		
Aspartame.....	161			Catechol.....	175,279,155		
L-Aspartic acid.....	145						
Astaxanthin.....	259,285		●				

Substance Index

	Refer to this catalogue on page	Refer to brochure YMC-Triart	Refer to brochure Chiral columns		Refer to this catalogue on page	Refer to brochure YMC-Triart	Refer to brochure Chiral columns
N-CBZ-DI-Alanine.....	248,259		●	γ-Cyclodextrin.....	143,209		
CBZ-Phenylalanine (Z-Phe-OH) /CBZ-Phenylalanine.....	264		●	Cyclamat-Na ⁺	21	●	
CCK-Octapeptide.....	201			L-Cystine.....	145		
5'-CDP.....	145			Cytidine.....	140,226		
CDP-D-glucose.....	143,155			Cytochrome c.....	98, 110,157,189,192,201,203, 209,211,216,217,220,236		
Cefaclor.....	292			Cytosine.....	48,49,52,126,133, 140,226	●	
Cefadroxil.....	140						
Cefatrizine propylene glycol.....	140			D			
Cefazolin Na.....	292			D4T.....	157		
Cefotaxime Na.....	292			Daidzein.....	41,44,111-113	●	
Cefoxitin Na.....	292			Daidzin.....	44,111-113	●	
Cefsulodin Na.....	292			5'-dAMP.....	145		
Cefuroxime Na.....	292			5'-dCMP.....	145		
Cephalexin.....	140,292			DDC.....	157		
Cephaloglycin.....	292			DDI.....	157		
Cephaloridine.....	140,292			α-Defensin-1 (human).....	219		
Cephalosporin C potassium.....	140			α-Defensin-2 (human).....	219		
Cephapirin Na.....	292			α-Defensin-3 (human).....	219		
Cephadrine.....	292			Dehydroacetic acid.....	121,131		
Cerebroside.....	171			Dehydrocerebroside.....	171		
Cetirizine.....	253,259		●	Dehydroisoandrosterone.....	293		
4-Chloroacetanilide.....	26	●		Delphinidin.....	45	●	
<i>m</i> -Chlorophenol.....	131			Delphinidin-3-O-arabinoside.....	45	●	
<i>o</i> -Chlorophenol.....	131			Delphinidin-3-O-galactoside.....	45	●	
<i>p</i> -Chlorophenol.....	131			Delphinidin-3-O-glucoside.....	45	●	
Chlorophyll a.....	285			Deoxyadenosine.....	140		
Chlorophyll b.....	285			Deoxycorticosterone.....	161,173		
Chlorophyll c ₁ +c ₂	285			Deoxycytidine.....	140		
Chlorpheniramine.....	18,20,25,55,57,58,99, 121,125,133,133,151	●		Deoxyguanosine.....	140		
Chloroquine.....	27,258	●	●	Deoxyinosine.....	140		
Chlortetracycline.....	23,37	●		Dexamethasone.....	143,293		
Cholecalciferol.....	30,147	●		Dextromethorphan HBr.....	18,20,55,57,58,99	●	
Cholesterol.....	147			5'-dGMP.....	145		
Chrysene.....	286,287			Diacylglycerol.....	171		
Chrysin.....	110			Diadinoxanthin.....	285		
α-Chymotrypsinogen A.....	98,216,217			Diatoxanthin.....	285		
Cinchonine.....	37, 112	●		Diazepam.....	314		
<i>trans</i> -Cinnamic acid.....	41	●		Dibenzo [a,h] anthracene.....	286,287		
Cinobufagin.....	147			Dicethiamine hydrochloride.....	291		
Citric acid.....	50	●		Dicloxacillin.....	90		
Clemastine.....	59	●		2,6-dimethylpyridine.....	146		
Clemastine fumarate.....	74			Diethanolamine.....	149		
Clindamycin hydrochloride.....	42,71,72,73	●		Diethylaniline.....	151		
5'-CMP.....	145			Diethyl phthalate.....	298		
Conalbumin.....	156,216			Digalactosyldiacylglycerol.....	171		
Corticosterone.....	143,161,173,293			Digitoxin.....	140		
Cortisone.....	118, 143 293			Dihydrocapsaicin.....	75		
Creatinine.....	207			Dihydroquinine.....	37,112	●	
<i>o</i> -Cresol.....	268		●	DL-3,4-Dihydroxymandelic acid.....	35, 133,140	●	
<i>m</i> -Cresol.....	268		●	3,4-Dihydroxyphenylacetic acid.....	35,133	●	
<i>p</i> -Cresol.....	268		●	3,4-Dihydroxyphenylalanine (DOPA).....	35,133,140	●	
Crotonaldehyde 2,4-DNPH.....	157			Diltiazem hydrochloride.....	126,127,131	●	
β-Cryptoxanthin.....	285			1,2-Dimethoxyl benzene.....	26	●	
5'-CTP.....	145			<i>o</i> -Dimethyl-β-cyclodextrin.....	143		
Cyanazine.....	291			Dimethylaniline.....	151		
Cyanidin.....	45	●		N,N-Dimethylethanolamine.....	149		
Cyanidin-3-O-arabinoside.....	45	●		Diphenhydramide.....	314		
Cyanidin-3-O-galactoside.....	45	●		Diphenhydramine hydrochloride.....	125		
Cyanidin-3-O-glucoside.....	45	●		Diphenyl.....	218		
Cyanocobalamin.....	44,51,155,157,159	●		Diquat.....	23	●	
α-Cyclodextrin.....	143, 209			Diuron.....	291		
β-Cyclodextrin.....	143, 209			1kb DNA ladder (75-12,126 bp).....	193		

Substance Index

	Refer to this catalogue on page	Refer to brochure YMC-Triart	Refer to brochure Chiral columns		Refer to this catalogue on page	Refer to brochure YMC-Triart	Refer to brochure Chiral columns
Donepezil	258		●	G			
DOPA (3,4-Dihydroxyphenylalanine)	140			5'-GDP	145		
Dopamine hydrochloride	35,133,140	●		Galactose	228		
Doxycycline	37	●		GDP-D-mannose	43,155		
Duloxetine amino alcohol	29	●		Gallic acid	122		
Duloxetine hydrochloride	29,249	●	●	Genistein	44,111-113	●	
Duloxetine ortho isomer	29	●		Genistin	44,111-113	●	
Duloxetine para isomer	29	●		γ-Globulin	201,207		
				Glucose (G1)	143,201,227		
E				Glutamate dehydrogenase	203,209,211		
Echineneone	285			L-Glutamic acid	145		
α-Endorphin	98,217			Gluten	86,87		
β-Endorphin (Human)	45,98,217,219	●		Glycine	145,190,201,210		
γ-Endorphin	45,98,217,219	●		Glycitein	44,111-113	●	
[D-Ala ² ,Met ⁵]-Enkephalinamide	98,217			Glycitol	44	●	
[D-Ala ² ,Met ⁵]-Enkephalin	98,217			Glycolic acid	50,140	●	
Leu-Enkephalin	45,131,149,201,219,220	●		Glycyrrhizic acid / Glycyrrhizin	25,74, 133,140	●	
Met-Enkephalin	45,98,149,201,217,219,220	●		5'-GMP	145		
Enolase	203,209,211			5'-GTP	145		
(-)-Epicatchin	292			Guaiacol	26	●	
(-)-Epicatechin gallate	292			Guanine	48,49,126,133,140	●	
(-)-Epigallocatechin	292			Guanosine	140,226		
(-)-Epigallocatechin gallate	292						
Epinephrine	133			H			
Ergocalciferol	30, 147	●		Halosulfuron methyl	19	●	
Erythorbic acid	44,51,53	●		Heparin	209		
Erythromycin	22,40,130	●		Hexobarbital	39,263,264,267	●	●
Erythromycin estolate	40	●		Hinokitiol	55,58,99	●	
Erythromycin ethylsuccinate	40	●		L-Histidine	145		
Esculine	140			Homovanillic acid	35,133,140	●	
α-Estradiol	269		●	Human IgA	207		
β-Estradiol	153, 269		●	Human IgG	207,208		
Estrilol	153			Humanised monoclonal IgG	194		
Estrone	153			Human IgM	207,208		
Ethanolamine	149			Human IgM (κ), myeloma protein	208		
Ethenzamide	74			Human serum albumin (HSA)	191,201,206		
Ethinylestradiol	153			Hydrochlorothiazide	43	●	
Ethosuximide	123			Hydrocortisone	143,161,173, 293		
Etizolam	36	●		Hydroquinone	122,155,175,279		
Ethylbenzene	101, 114, 116			2-Hydroxyacetophenone	26,121	●	
n-Propylbenzene	101, 114, 116,132			4'-Hydroxyacetophenone (p)	151		
				4-Hydroxybenzoic acid	314		
F				Methyl p-hydroxybenzoate	41,100	●	
Ferritin	220			Ethyl p-hydroxybenzoate	100		
Fexofenadine hydrochloride	32,33	●		Isopropyl p-hydroxybenzoate	100		
Fibrinogen	201,207			Propyl p-hydroxybenzoate	100		
Flazasulfuron	19	●		Isobutyl p-hydroxybenzoate	100,124		
Fluoranthene	286,287			Butyl p-hydroxybenzoate	100		
Fluorobiprofen	267		●	5-Hydroxyindol-3-acetic acid	35,140	●	
Fluorene	286,287			4-Hydroxy-3-methoxymandelic acid	133		
Fluoxymesterone	169,293			4-Hydroxy-3-methoxyphenylglycol	133,140		
Flurbiprofen	131			Hydroxychloroquine	27,258	●	●
Folic acid	51	●		Hypoxanthine	140		
Formaldehyde 2,4-DNPH	157						
Formic acid	50,58	●		I			
Fructose	227,228			Ibuprofen	31,74,244	●	●
Fucoesterol	147			IgA	201		
Fucoxanthin	285			IgG	201		
(5,6)-Fullerene	155			IgM	201		
Fumaric acid	50,140,149	●		IgY	195		
Furazolidone	143,293			5'-IMP	145		
				Imipramine	24	●	
				Indeno(1,2,3-c,d)pyrene	286,287		

Substance Index

	Refer to this catalogue on page	Refer to brochure YMC-Triart	Refer to brochure Chiral columns		Refer to this catalogue on page	Refer to brochure YMC-Triart	Refer to brochure Chiral columns
Indometacin (Indomethacin).....	118,146			Malvidin-3-O-galactoside	45	●	
Inosine.....	140			Malvidin-3-O-glucoside	45	●	
Insulin.....	149,217			Mandelic acid.....	250		●
Insulin (Bovine).....	22,98,190,201,210,216,220,310	●		Mannose	228		
Insulin (Human).....	22	●		α -Mating factor	149,201,220		
Insulin (Porcine).....	22	●		Mecoprop.....	19	●	
Insulin B Chain.....	201			Medroxyprogesterone acetate	153		
D-Isoascorbic acid	44,51,53	●		Mestranol	153		
Isobutyl p-hydroxybenzoate.....	42	●		Metformin HCl.....	52	●	
Isobutyraldehyde 2,4-DNPH	157			L-Methionine	145		
L-Isoleucine.....	145			DL-3-Methoxy-4-Hydroxymandelic acid	140		
Isonicotinic acid.....	153,292			3-Methoxy-4-hydroxyphenylglycol	35	●	
Isonicotinic acid hydrazide.....	153,292			3-Methoxytyramine hydrochloride.....	35,133	●	
Isoproturon.....	291			Methyl benzoate... 26,55,58,99,108,109,114,131,236,299		●	
				4-Methylcatechol.....	24	●	
K				N-Methylethanolamine	149		
Kaempferol.....	41,110	●		Methylethyketone 2,4-DNPH.....	157		
Ketamine HCl.....	265		●	N-Methylnicotinamide	153,292		
Ketoprofen	267		●	Methylparaben	146		
				Methylprednisolone	143,169,293		
L				2-Methylresorcinol.....	24	●	
L α -Lactalbumin.....	201,216			2,5-Methylresorcinol.....	24	●	
Lactate dehydrogenase.....	203,209,211			Methyltestosterone	293		
Lactic acid.....	50,140,149,	●		Metobromuron	291		
β -Lactoglobulin.....	220			Metoxuron	291		
β -Lactoglobulin A.....	216			Metoprolol.....	23,251	●	●
β -Lactoglobulin B	216			Monogalactosyldiacylglycerols	171		
Lactose	227			Mouse IgG Fab fragment.....	208		
Lansoprazole	260		●	Mouse IgG Fc fragment.....	208		
L-Leucine	145		●	Mouse monoclonal IgG1.....	192, 208		
Levofloxacin	261		●	MPPH	314		
Lidocaine.....	126,127,131			Myoglobin	157,190,201,206,216		
Lincomycin hydrochloride	42	●		Myricetin	110		
Linomycin HCl.....	42						
Linuron	291			N			
Lipoxidase.....	156,216			Nadolol.....	23	●	
Lutein.....	285			Nalidixic acid.....	143,293		
Luteolin.....	41	●		Naphazoline hydrochloride.....	25,133	●	
Lycopene.....	285			Naphthalene.....	31,66,108,109,130,218,236,286,287	●	
L-Lysine	145			α -Naphthol	27	●	
L-Malic acid.....	149			1-(1-Naphthyl)-ethylalcohol.....	268		●
Lysophosphatidylcholine	171			Neostigmine methylsulfate	25,133	●	
Lysozyme	98,157,189,192,207,216,217,220,236,320			Neoxanthin	285		
				Neurotensin.....	45,190,201,210,219	●	
M				Nicardipine hydrochloride	126,127,131		
Maleate.....	151			Nicotinamide	44,51,153,159,292	●	
Maleic acid.....	25,50,133,140,149	●		Nicotinic acid	42,44,51,153,292	●	
L-Malic acid.....	50, 140	●		Nitrobenzene.....	68		
Malonic acid.....	50, 140	●		4-Nitrocatechol.....	24	●	
6''-o-Malonyldaidzin	44,111-113	●		4-Nitrophenol.....	24	●	
6''-o-Malonylgenistin	44, 111-113	●		o-Nitrophenol.....	269		●
6''-o-Malonylglucitol	44,111-113	●		m-Nitrophenol.....	269		●
Maltododecaose (G12)	227			p-Nitrophenol.....	269		●
Maltoheptaose (G7)	202			Noradrenaline	35,140	●	
Maltopentadecaose (G15)	202,227			Nordihydrocapsaicin.....	74		
Maltopentaose (G5).....	202			Norepinephrine hydrochloride.....	133		
Maltose (G2).....	202,227			Norethisterone	153		
Maltotetradecaose (G14)	227			Nortiptilin.....	24	●	
Maltotridecaose (G13)	227						
Maltotriose (G3)	202			○			
Maltoundecaose (G11).....	202,227			Ofloxacin	261		●
Malvidin.....	45	●		Olaquinox.....	143,293		
Malvidin-3-O-arabinoside	45	●		Oligonucleotide.....	75,220,221		

Substance Index

	Refer to this catalogue on page	Refer to brochure YMC-Triart	Refer to brochure Chiral columns		Refer to this catalogue on page	Refer to brochure YMC-Triart	Refer to brochure Chiral columns
Orotic acid.....	159			Propionaldehyde 2,4-DNPH.....	157		
Ouabagenin.....	123			Propionic acid.....	50,58, 140,149	●	
Ovalbumin.....	149,190,201,216,220			Propranolol HCl.....	23,56,126,127, 253,254,264,269	●	●
Oxalic acid.....	50	●		Propyl p-hydroxybenzoate.....	99		
Oxine-copper.....	19	●		Propylbenzene.....	31,123	●	
Oxolinic acid.....	143,293			Propylparabene.....	18,20	●	
Oxytetracycline hydrochloride.....	23,37,123	●		Pseudoephedrine.....	151		
Oxytocin.....	45,131,201,219,220	●		Pullulan P-5 (MW 5,800).....	202		
				Pullulan P-10 (MW 12,200).....	202		
P				Pullulan P-20 (MW 23,700).....	202		
PA-diheptadecanoyl.....	171			Pullulan P-50 (MW 48,000).....	202		
D-(+)-Pantothenic acid calcium salt.....	51	●		Pullulan P-100 (MW 100,000).....	202		
Paraquat.....	23	●		Pullulan P-200 (MW 186,000).....	202		
PCB 28.....	287			Pullulan P-400 (MW 380,000).....	202		
PCB 52.....	287			Pullulan P-800 (MW 853,000).....	202		
PCB 101.....	287			Pyrene.....	286,287		
PCB 138.....	287			Pyridine.....	116,146,299		
PCB 153.....	287			Pyridylamino.....	228		
PCB 180.....	287			Pyridoxal hydrochloride.....	51	●	
PE-dipalmitoyl.....	171			Pyridoxine hydrochloride.....	25,44,51,133,159	●	
Pentaglycine.....	210			Pyrocatechol.....	24,26	●	
Pentobarbital.....	39	●		Pyrogallol.....	155,175,279		
Peonidin.....	45	●		Pyrrroloquinoline quinone (PQQ).....	159		
Peonidin-3-O-arabinoside.....	45	●					
Peonidin-3-O-galactoside.....	45	●		Q			
Peonidin-3-O-glucoside.....	45	●		Quercetin.....	110		
Peptide mapping.....	190,191,206,217			Quinidine.....	126,127		
Perylene.....	287			Quinizarin.....	121		
Petunidin.....	45	●		Quinine.....	37,112	●	
Petunidin-3-O-arabinoside.....	45	●		8-Quinolol.....	31,291	●	
Petunidin-3-O-galactoside.....	45	●					
Petunidin-3-O-glucoside.....	45	●		R			
Phaephorbid b.....	285			Rabbit IgG.....	208		
Phenacetine.....	27	●		Rabeprazole.....	260		●
Phenanthrene.....	286,287			Rebaudioside A.....	25	●	
Phenformin HCl.....	52	●		Resibufogenin.....	147		
Phenobarbital.....	39,123	●		Resorcinol.....	24,153,175,279		
Phenol.....	26,116,120,125,147,151,155,175,279	●		α -Resorcylic acid.....	153		
Phenylalanine.....	140			β -Resorcylic acid.....	153		
L-Phenylalanine.....	145			γ -Resorcylic acid.....	153		
1-Phenylethanol.....	263		●	Retinol palmitate.....	169		
Phenylethylalcohol.....	268		●	Riboflavin.....	44,51,155,157,159	●	
Phenylpropanolamine hydrochloride.....	151			Ribonuclease A.....	157,189,192,201,216,220,236		
2-Phenylpropionic acid.....	277						
Phenytol.....	123,126,127			S			
Phloroglucinol.....	175,279			Saccharin Na.....	21	●	
Phosphatidylcholine.....	171			Saikosaponin a.....	293		
Phosphatidylethanolamine.....	171			Saikosaponin b2.....	293		
Phosphatidyl glycerols.....	171			Saikosaponin c.....	293		
Phosphatidylinositol.....	171			Saikosaponin d.....	293		
PI, PC, PS-diheptadecanoyl.....	171			Salicin.....	140		
Pindolol.....	23,260	●	●	Salicylic acid.....	27,41,125 147	●	
Piromidic acid.....	143,293			Scopolamine.....	37,112,151	●	
Plasmid pBR322.....	193,205			Sebuthylazine.....	291		
Prednisolone.....	169			Secobarbital.....	39	●	
Primidone.....	123			L-Serine.....	145		
Procainamide.....	125,151			Serotonin hydrochloride.....	35	●	
Procainamide hydrochloride.....	125			Sertraline hydrochloride.....	252		●
Progesterone.....	123,153,161,173			Siduron.....	19	●	
L-Proline.....	145			Simazine.....	291		
Prometon.....	291			β -Sitosterol.....	147		
Prometryn.....	291			Sorbic acid.....	121,131		
Propazine.....	291			Sphingomyelin.....	171		

Substance Index

	Refer to this catalogue on page	Refer to brochure YMC-Triart	Refer to brochure Chiral columns		Refer to this catalogue on page	Refer to brochure YMC-Triart	Refer to brochure Chiral columns
Spiarmycin	22	●		Toluene.....	24,68,123,132,151,298,299,314	●	
Sterol Esters.....	171			Transferrin	201,207		
Sterols.....	171			Triamcinolone acetonide	143,293		
Steryl glycosides.....	171			Triazolam.....	36	●	
Steryl oleate	171			Triclopyr	19	●	
Stevioside hydrate	25	●		Triethanolamine.....	149		
Stigmasterol.....	147			2,2,2-Trifluoro-1-(9-anthryl) ethanol	263,265		●
Stigmasterol / sitosterol.....	171			Triglycine.....	210		
trans-Stilbene oxide	244,247,249,277		●	o-Trimethyl-β-cyclodextrin.....	143		
G-Strophanthin	123,140			Triphenylene.....	31,119,124	●	
Succinic acid.....	50,140,149	●		Trypsin inhibitor (soybean)	190,201		
Sucrose.....	227			Tryptophan.....	35	●	
Sulfadiazine.....	90			5'-TTP	145		
Sulfadimethoxine.....	143,293			Tyrosine.....	35,140	●	
Sulfadimidine	143,293			L-Tyrosine.....	145		
Sulfamerazine	143,293						
Sulfamonomethoxine.....	143, 118, 293			U			
Sulfaquinoxaline.....	143,293			UDP-D-glucose	143,155		
Sulfoquinovosyldiacylglycerol	171			UDP-N-acetyl-D-glucosamine	143,155		
Sulphamerazin	22	●		5'-UMP	145		
Sulphamethaxole.....	22	●		Uracil	22,48,49,52,126,133, 140,151, 291	●	
Sulphathiazole	22	●		Uric acid.....	207		
				Uridine.....	140,226		
T				5'-UTP	145		
TAG / Tripentadecanoin.....	171						
Tartaric acid	50	●		V			
5'-TDP.....	145			n-Valeraldehyde 2,4-DNPH	157		
Terbumeton.....	291			L-Valine.....	145		
Terbutylazine.....	291			Valsartan	43,252		●
Terbutryn.....	291			Vanillic acid	140		
m-Terphenyl	128			Vaillylmandelic acid	35	●	
o-Terphenyl	31,119,124,128	●		[Arg8]-Vasopressin	131		
p-Terphenyl	128			Verapamil	56,126,127,131,253	●	●
Testosterone	31,132, 293	●		Violaxanthin	285		
Tetracycline hydrochloride	23,37,123,190	●		Vitamin B1	44	●	
Tetraglyzine	190,201			Vitamin B2.....	44	●	
Tetrahydrozoline HCl.....	25	●		Vitamin B6.....	44	●	
Theophylline.....	125,147			Vitamin B12.....	44	●	
Thiamine hydrochloride	44,51	●		Vitamin C.....	44	●	
Thiamphenicol	143,293			Vitamin D2.....	30	●	
Thiram	19	●		Vitamin D3.....	30	●	
L-Threonine	145						
Thymidine.....	140			W			
Thymine.....	48,49,126,133, 140	●		Warfarin.....	246,259		●
Thyroglobulin	201						
5'-TMP	145			X			
α-Tocopherol.....	168,169,177			Xanthine	140		
β-Tocopherol.....	168,169,177			Xanthosine	140		
γ-Tocopherol.....	168,169,177						
δ-Tocopherol	168,169,177			Z			
p-Tolualdehyde 2,4-DNPH.....	157			Zeaxanthin	285		

Ordering Information Guide

The previous product listing represents commonly used standard column dimension. In order to identify any specific product version and order number, please see the example and the table below.

Full listing of all chemistries and dimensions

Gel Code								Hardware Code					
Chemistry Code		Pore size [nm]		Particle shape		Particle size [µm]		Length [mm]		Inner diameter [mm]		Column Type	
YMC Carotenoid	CT	6	06	spherical	S	1.9	P9	5	E5	0.075	E8	Parker type	PTH
YMC-Triart C18	TA	8	08			2.0	02	10	01	0.1	F0	Parker type UHPLC	PT
YMC-Triart C18 ExRS	TAR	12	12			2.7	Q7	20	02	0.3	H0	Quick Seal	QT
YMC-Pack Pro C18	AS	16	16			3.0	03	30	03	0.5	J0	Quick Seal cartridge	QC
YMC-Pack Pro C18 RS	RS	20	20			4.0	04	33	H3	1.0	01	Biocompatible PEEK	WP
Hydrosphere C18	HS	30	30			5.0	05	50	05	2.0	02	Waters type	WT
Meteoric Core C18	CAS	100	A0			6.0	06	75	L5	2.1	Q1	Analytical guard cartridges	GC
Meteoric Core C18 BIO	CAW	proprietary	99			10	11	100	10	3.0	03	Capillary 1/16" fittings	AU
YMC-Pack ODS-A	AA	non-porous	00			15	16	125	R5	4.0	04	Capillary 1/32" fittings	RU
YMC-Pack ODS-AM	AM					20	21	150	15	4.6	46	Actus semi prep. 20/30 mm ID	WX
YMC-Pack ODS-AQ	AQ					30	30	250	25	6.0	06	Actus semi prep. 50 mm ID	DX
J'sphere ODS-H80	JH					50	50	300	30	8.0	08	Semi prep./UHPLC guard cartridges	CC
J'sphere ODS-M80	JM					60	60	500	50	10	10	Semi prep. guard	WTG
J'sphere ODS-L80	JL					75	75			20	20	Alcyon SFC	WTS
YMC-Pack ODS-AL	AL									30	30		
YMC-Pack PAH	YP									50	53		
YMC-Pack PolymerC18	PC												
YMC-Triart C8	TO												
YMC-Pack Pro C8	OS												
Meteoric Core C8	COS												
YMC-Pack C8 (Octyl)	OC												
YMCbasic	BA												
YMC-Triart Phenyl	TPH												
YMC-Pack Ph (Phenyl)	PH												
YMC-Triart PFP	TPF												
YMC-Pack Pro C4	BS												
YMC-Pack C4 (Butyl)	BU												
YMC-Pack Protein-RP	PR												
YMC-Pack TMS (C1)	TM												

Example

YMC-Triart C18		12 nm		Spherical		1.9 µm		50 mm		2.0 mm		Parker type UHPLC	
	TA		12		S		P9		05		02		PT

Your part number: **TA12SP9-0502PT** (Example)

Ordering Information Guide

Full listing of all chemistries and dimensions

Gel Code								Hardware Code					
Chemistry Code		Pore size [nm]		Particle shape		Particle size [µm]		Length [mm]		Inner diameter [mm]		Column Type	
YMC-Pack PVA-Sil	PV	6	06	spherical	S	1.9	P9	5	E5	0.075	E8	Parker type	PTH
YMC-Pack Polyamine II	PB	8	08			2.0	Q2	10	O1	0.1	F0	Parker type UHPLC	PT
YMC-Pack NH2 (Amino)	NH	12	12			2.7	Q7	20	O2	0.3	H0	Quick Seal	QT
YMC-Pack CN (Cyano)	CN	16	16			3.0	Q3	30	O3	0.5	J0	Quick Seal cartridge	QC
YMC-Triart Diol-HILIC	TDH	20	20			4.0	Q4	33	H3	1.0	O1	Biocompatible PEEK	WP
YMC-Triart Diol (SFC)	TDL	30	30			5.0	Q5	50	O5	2.0	O2	Waters type	WT
YMC-Pack Diol NP	DN	100	A0			6.0	Q6	75	L5	2.1	Q1	Analytical guard cartridges	GC
YMC-Pack SIL (Silica)	SL	proprietary	99			10	11	100	10	3.0	O3	Capillary 1/16" fittings	AU
CHIRAL ART Amylose-C	KAN	non-porous	00			15	16	125	R5	4.0	O4	Capillary 1/32" fittings	RU
CHIRAL ART Cellulose-C	KCN					20	21	150	15	4.6	46	Actus semi prep. 20/30 mm ID	WX
CHIRAL ART Amylose-SA	KSA					30	30	250	25	6.0	O6	Actus semi prep. 50 mm ID	DX
CHIRAL ART Cellulose-SB	KSB					50	50	300	30	8.0	O8	Semi prep./UHPLC guard cartridges	CC
CHIRAL ART Amylose-SE	KSE					60	60	500	50	10	10	Semi prep. guard	WTG
CHIRAL ART Cellulose-SC	KSC					75	75			20	20	Alcyon SFC	WTS
YMC Chiral NEA (R) (NP)	CR									30	30		
YMC Chiral NEA (S) (NP)	CS									50	53		
YMC Chiral NEA (R) (RP)	NR												
YMC Chiral NEA (S) (RP)	NS												
YMC Chiral CD BR α	DA												
YMC Chiral CD BR β	DB												
YMC Chiral CD BR γ	DG												
YMC-Pack Diol (SEC)	DL												
YMC-BioPro QA	QA												
YMC-BioPro SP	SP												
YMC-BioPro QA-F	QF												
YMC-BioPro SP-F	SF												

Example

CHIRAL ART Amylose-SA		Proprietary		Spherical		3.0 µm		150 mm		3.0 mm		Waters type	
	KSA		99		S		03		15		03		WT

Your part number: **KSA99S03-1503WT (Example)**

Please note that combinations of features cannot be selected at random, but only from the possible specifications for a chosen stationary phase. These can be determined from the individual product sections in this catalogue or from our homepage www.ymc.de.

For more details



contact your local distributor or

YMC Europe GmbH, Schöttmannshof 19, D-46539 Dinslaken, Phone: +49 (0) 2064 / 427-0,
Fax +49 (0) 2064 / 427-222, e-mail: info@ymc.de, homepage: www.ymc.de

Analytical stationary phases

		PRODUCT	PHASE (silica-based unless stated)	END-CAPPED	USP CLASS NO.
Reversed Phase	C30	Carotenoid	proprietary polymeric bonding chemistry	—	L62
		C18	Triart C18 ExRS	pH-stable organic/inorganic hybrid particle for steric recognition	yes
	Triart C18		pH-stable organic/inorganic hybrid particle, 100% aqueous conditions possible	yes	L1
	<i>Pro</i> C18		very low residual non-specific interactions	yes	L1
	UltraHT		2 µm <i>Pro</i> C18 for fast and ultra fast separations		
	<i>Pro</i> C18 RS		high carbon load with polymeric bonding C18	yes	L1
	Hydrosphere C18		can be used in 100% aqueous eluent	yes	L1
	UltraHT		2 µm Hydrosphere C18 for fast and ultra fast separations		
	Meteoric Core C18		silica based Core-Shell particle	yes	L1
	Meteoric Core C18 BIO		silica based Core-Shell particle	yes	L1
	ODS-A		one of the YMC's international bestsellers	yes	L1
	ODS-AM		high performance C18 column for validated methods operation	yes	L1
	ODS-AQ		"hydrophilic" endcapping, for 100% aqueous eluent systems	yes	L1
	J'sphere ODS		C18-family with differently controlled hydrophobicity for method development	yes	L1
	ODS-AL		traditional C18 for "mixed mode" separations	no	L1
	PolymerC18	polymethacrylate matrix, wide pH applicability	—	—	
	C8	Triart C8	pH-stable organic/inorganic hybrid particle	yes	L7
		<i>Pro</i> C8	C8, with very low residual non-specific interactions	yes	L7
		Meteoric Core C8	silica based Core-Shell particle	yes	L7
		C ₈ (Octyl)	traditional C8	yes	L7
		YMCbasic	monomeric bonded chains of C8 and smaller	—	L7
Ph (Phenyl)	Ph (Phenyl)	monomeric bonded phenyl	yes	L11	
	Triart Phenyl	polymeric bonding phenyl butyl, organic/inorganic hybrid particle	yes	L11	
	Triart PFP	polymeric bonding PFP propyl, organic/inorganic hybrid particle	no	L43	
C4	<i>Pro</i> C4	C4, with very low residual non-specific interactions	yes	L26	
	C ₄ (Butyl)	traditional C4	yes	L26	
	Protein-RP	high stability, good recovery rates	—	L26	
	YMC-PAH	proprietary bonding chemistry	—	—	
TMS (C1)	trimethyl silane	—	L13		
Normal Phase / HILIC	PVA-SIL	polyvinyl alcohol bonded on silica support	—	L24	
	Polyamine II	mixed secondary and tertiary amino derivative	—	—	
	NH ₂ (Amino)	primary amino derivate	—	L8	
	CN (Cyano)	useful for SFC applications, can be used in RP mode	yes	L10	
	Triart-Diol HILIC	versatile HILIC phase, organic/inorganic hybrid particle	—	L20	
	Diol (DN)	versatile alternative to silica for normal phase separations	—	L20	
SIL (Silica)	ultra high purity, high mechanical stability	—	L3		
IEX	BioPro QA / SP	high ion exchange capacity, porous hydrophilic polymer	—	—	
	BioPro QA-F / SP-F	high ion exchange capacity, non-porous hydrophilic polymer	—	—	
SEC	Diol-60, -120, -200, -300	versatile phase for gel filtration separations	—	L20	
Chiral	Amylose-C	coated derivative [alternative to CHIRALPAK® AD-H, AD-3]	—	L51	
	Cellulose-C	coated derivative [alternative to CHIRALCEL® OD-H, OD-3]	—	L40	
	Amylose-SA	immobilised derivative [alternative to CHIRALPAK® IA, IA-3]	—	—	
	Cellulose-SB	immobilised derivative [alternative to CHIRALPAK® IB, IB-3]	—	—	
	Cellulose-SC	immobilised derivative [alternative to CHIRALPAK® IC, IC-3]	—	—	
	Amylose-SE	immobilised derivative [alternative to CHIRALPAK® IE, IE-3]	—	—	
	NEA (R)(S)	polymeric 1-naphthylethylamine	—	—	
α-, β-, γ-CD BR	α-, β-, γ-bromo-cyclodextrin	—	—		

routinely available from **YMC**

PARTICLE SIZE (µm spherical)	PORE SIZE (nm)	CARBON LOAD (%C)	pH	TYPICAL APPLICATIONS	Page
3, 5	proprietary	proprietary	2.0-7.5	isomeric carotenes, retinols, steroids, fat-soluble vitamins	284
1.9, 3, 5	8	25	1.0-12.0	stereoisomers and hydrophobic analytes	14
1.9, 3, 5	12	20	1.0-12.0	acidic, neutral, basic compounds, "versatile" stationary phase	14
3, 5	12	16	2.0-8.0	antioxidants, metabolites	122
2					106
3, 5	8	22	1.0-10.0	acidic and basic compounds	128
3, 5	12	12	2.0-8.0	strong polar compounds, water-soluble vitamins	132
2					106
2.7	8	7	1.5-10	basic, coordinating compounds, fast separations	96
2.7	16	5	1.5-10	peptides, proteins, fast separations	96
3, 5	12, 20, 30	17, 12, 7	2.0-7.5	general purpose phase	142
3, 5	12	17	2.0-7.5	purines, phenols, PTC-amino acids, angiotensins, alkaloids	144
3, 5	12, 20	14, 10	2.0-7.5	strong polar compounds	138
4	8	22, 14, 9 (JH, JM, JL)	1.0-9.0 (JH) 2.0-7.5 (JM+JL)	positional isomers, complexing agents, pharmaceuticals	288
5	12	17	2.0-7.5	tocopherols, fat-soluble vitamins, disinfectants	146
6	proprietary	10	2.0-13.0	phenols, anilines, quaternary amines	148
1.9, 3, 5	12	17	1.0-12.0	acidic, neutral, basic and chelating compounds, metabolites, "versatile" stationary phase	14
3, 5	12	10	2.0-7.5	acidic, neutral, basic and chelating compounds, drugs and metabolites	124
2.7	8	5	1.5-9.0	basic, coordinating compounds, fast separations	96
3, 5	12, 20, 30	10, 7, 4	2.0-7.5	proteins and peptides, estrogens, general purpose phase	152
3, 5	20	7	2.0-7.5	basic molecules w/o modifiers, anilines, alkaloids, antidepressants	150
3, 5	12, 30	9, 3	2.0-7.5	phenols, fullerenes, sweeteners	154
1.9, 3, 5	12	17	1.0-10.0	pharmaceuticals, sweeteners	14
1.9, 3, 5	12	15	1.0-8.0	halogenated and polar compounds	14
3, 5	12	7	2.0-7.5	polar acidic, neutral, basic and chelating compounds, polar peptides	126
3, 5	12, 20, 30	7, 5, 3	2.0-7.5	biological separations, polar compounds	156
5	20	4	1.5-7.5	proteins, peptides	214
3, 5	proprietary	proprietary	2.0-8.0	polyaromatic hydrocarbons	286
3, 5	12	4	2.0-7.5	water-soluble vitamins	158,179
5	12	—	2.0-9.5	phospholipids, retinoids, lipids	170
5	12	—	2.0-7.5	malto-oligosaccharides, tocopherols, nucleotides, sugars	176
3, 5	12	—	2.0-7.5	sugars, nucleotides, water-soluble vitamins	178
3, 5	12, 30	7, 3	2.0-7.5	proteins, steroids, catechols	160,172
1.9, 3, 5	12	—	2.0-10.0	small organic molecules, water-soluble vitamins	14
5	6, 12	—	2.0-7.5	small organic molecules, fat-soluble vitamins, tocopherols	174
3, 5	6, 12	—	2.0-7.5	small organic molecules, fat-soluble vitamins, tocopherols	168
5	100	—	2.0-12.0	proteins, peptides, nucleotides	188
3, 5	—	—	2.0-12.0	proteins, peptides, nucleotides	188
3, 5	6, 12, 20, 30	—	5.0-7.5	peptides, proteins, malto-oligosaccharides	200
3, 5	proprietary	—	—	chiral compounds in NP, SFC modes	244
3, 5	proprietary	—	—	chiral compounds in NP, SFC modes	244
3, 5	proprietary	—	2.0-9.0	<i>cis-trans</i> and geometric isomers in NP, RP, SFC modes	254
3, 5	proprietary	—	2.0-9.0	<i>cis-trans</i> and geometric isomers in NP, RP, SFC modes	254
3, 5	proprietary	—	2.0-9.0	<i>cis-trans</i> and geometric isomers in NP, RP, SFC modes	254
3, 5	proprietary	—	2.0-9.0	<i>cis-trans</i> and geometric isomers in NP, RP, SFC modes	256
5	30	—	2.0-6.5	nonpolar to medium polar optical isomers for NP, RP modes	262
5	12	—	3.5-6.5	optical and positional isomers in RP mode	266

The following brands or trademarks are the property of the listed company and/or its subsidiaries. Every effort has been taken to ensure this list is accurate at the time of printing this brochure.

Acquity UPLC BEH C18, Acquity UPLC CSH C18, Atlantis dC18, Atlantis T3, Cortecs, SunFire C18, Symmetry C18, Symmetry C8, X-Bridge C18, XTerra MS C18 OBD are trademarks of Waters Corp.

Ascentis Express C18 is a trademark of Sigma-Aldrich.

Bio-Rad is a trademark of Bio-Rad Laboratories Inc.

Capcell Pak MG-II, Capcell Pak C18 AQ are trademarks of Shiseido Co., Ltd.

CHIRALPAK and CHIRALCEL are registered trademarks of Daicel Corporation.

Daisogel is a trademark of Daiso Co., Ltd.

Ekspert is a trademark of AB Sciex Pte. Ltd.

GE is a trademark of General Electric Company.

Gemini, Gemini NX, Kinetex are trademarks of Phenomenex, Inc.

Hypersil GOLD and ProPac WCX-10 are trademarks of Thermo Fisher Scientific.

Intertsil ODS-3V, Intertsil ODS-3, Intertsil ODS-4, Inertsil C8-3 are trademarks of GL Sciences, Inc.

Kromasil is a trademark of Akzo Nobel, Separation Products.

L-column is a trademark of Chemicals Evaluation and Research Institute.

Mini Q, Mono Q and Mono S are trademarks of General Electric Company as GE Healthcare.

Pall is a trademark of Pall Corporation.

ReproSil-Pur C18-AQ is a trademark of Dr. Maisch GmbH.

SureFit is a trademark of IDEX Corporation.

TSKgel ODS-100S, TSKgel DEAE-NPR, TSKgel SP-NPR, TSKgel BioAssist Q and TSKgel BioAssist S are trademarks of Tosoh Bioscience LLC.

Zorbax Extend-C18, Zorbax StableBond, Zorbax Eclipse Plus, Zorbax Eclipse XDB-C18, Zorbax SB-C18 and Zorbax XDB-C18 are trademarks of Agilent Technologies, Inc.



Your local distributor:



YMC CO., LTD.

YMC Karasuma-Gojo Bld. 284 Daigo-cho,
Karasuma Nisiiru Gojo-dori Shimogyo-ku,
Kyoto 600-8106 Japan
TEL. +81(0)75-342-4515, FAX +81(0)75-342-4550
www.ymc.co.jp

YMC Europe GmbH

Schöttmannshof 19
D-46539 Dinslaken
Germany
TEL. +49(0)2064/427-0, FAX +49(0)2064/427-222
www.ymc.de

YMC America, Inc.

941 Marcon Boulevard Suite 201
Allentown, PA18109 USA
TEL. +1-610-266-8650, FAX +1-610-266-8652
www.ymcamerica.com

YMC Taiwan Co., Ltd.

3F, No. 1353, Zhongzheng Rd.,
Taoyuan City, Taoyuan Country 330,
Taiwan (R.O.C.)
TEL. +886-3-2150-630, FAX +886-3-2150-286
www.ymctaiwan.com

YMC Korea Co., Ltd.

#208, Owners Tower, 16-5, Sunae-dong,
Bundang-gu, Seongnam-si, Gyeonggi-do,
463-825 Korea
TEL. +82-31-716-1631, FAX +82-31-716-1630
www.ymckorea.com

YMC India Pvt. Ltd.

A-154, Eros Boulevard Hilton Hotel Complex Plot
No.13-B, District Centre Mayur Vihar Phase-I
New Delhi-110091 India
TEL. +91-11-45041601;45041701, FAX +91-11-45041901
www.ymcindia.com

YMC Co., Ltd. Shanghai Rep. Office

Far East International Plaza A2404
No. 319 Xianxia Road, Shanghai 200051
P.R. China
TEL. +86-21-6235-1388, FAX +86-21-6235-1398
www.ymcchina.com

YMC Singapore Tradelinks Pte. Ltd.

6 Indus Road, #13-09 Emerald Park, Tower 1,
Singapore 169588
TEL.+65-9023-7617
www.ymc.sg